

2N6034G, 2N6035G, 2N6036G (PNP), 2N6038G, 2N6039G (NPN)



ON Semiconductor®

<http://onsemi.com>

Plastic Darlington Complementary Silicon Power Transistors

Plastic Darlington complementary silicon power transistors are designed for general purpose amplifier and low-speed switching applications.

Features

- ESD Ratings: Machine Model, C; > 400 V
Human Body Model, 3B; > 8000 V
- Epoxy Meets UL 94 V-0 @ 0.125 in
- These Devices are Pb-Free and are RoHS Compliant*

MAXIMUM RATINGS

Rating	Symbol	Value	Unit
Collector-Emitter Voltage 2N6034G 2N6035G, 2N6038G 2N6036G, 2N6039G	V_{CEO}	40 60 80	Vdc
Collector-Base Voltage 2N6034G 2N6035G, 2N6038G 2N6036G, 2N6039G	V_{CBO}	40 60 80	Vdc
Emitter-Base Voltage	V_{EBO}	5.0	Vdc
Collector Current - Continuous	I_C	4.0	Adc
Collector Current - Peak	I_{CM}	8.0	Apk
Base Current	I_B	100	mAdc
Total Device Dissipation @ $T_C = 25^\circ\text{C}$ Derate above 25°C	P_D	40 320	W mW/ $^\circ\text{C}$
Total Device Dissipation @ $T_C = 25^\circ\text{C}$ Derate above 25°C	P_D	1.5 12	W mW/ $^\circ\text{C}$
Operating and Storage Junction Temperature Range	T_J, T_{stg}	-65 to +150	$^\circ\text{C}$

Stresses exceeding those listed in the Maximum Ratings table may damage the device. If any of these limits are exceeded, device functionality should not be assumed, damage may occur and reliability may be affected.

THERMAL CHARACTERISTICS

Characteristic	Symbol	Max	Unit
Thermal Resistance, Junction-to-Case	$R_{\theta JC}$	3.12	$^\circ\text{C}/\text{W}$
Thermal Resistance, Junction-to-Ambient	$R_{\theta JA}$	83.3	$^\circ\text{C}/\text{W}$

*For additional information on our Pb-Free strategy and soldering details, please download the ON Semiconductor Soldering and Mounting Techniques Reference Manual, SOLDERRM/D.

4.0 AMPERES DARLINGTON COMPLEMENTARY SILICON POWER TRANSISTORS 40, 60, 80 VOLTS, 40 WATTS

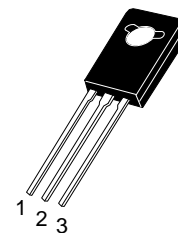
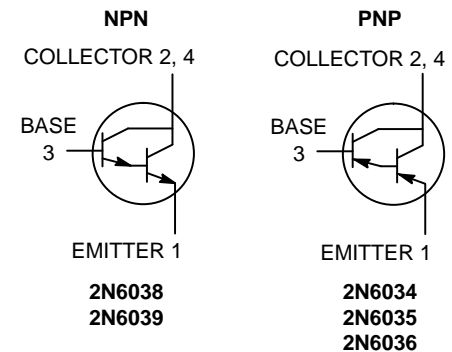

TO-225
CASE 77-09
STYLE 1

MARKING DIAGRAM

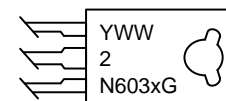

- Y = Year
WW = Work Week
2N603x = Device Code
x = 4, 5, 6, 8, 9
G = Pb-Free Package

ORDERING INFORMATION

See detailed ordering and shipping information in the package dimensions section on page 5 of this data sheet.

2N6034G, 2N6035G, 2N6036G (PNP), 2N6038G, 2N6039G (NPN)

ELECTRICAL CHARACTERISTICS (T_C = 25°C unless otherwise noted)

Characteristic	Symbol	Min	Max	Unit
OFF CHARACTERISTICS				
Collector–Emitter Sustaining Voltage (I _C = 100 mA _{dc} , I _B = 0) 2N6034G 2N6035G, 2N6038G 2N6036G, 2N6039G	V _{CEO(sus)}	40 60 80	– – –	V _{dc}
Collector–Cutoff Current (V _{CE} = 40 V _{dc} , I _B = 0) 2N6034G (V _{CE} = 60 V _{dc} , I _B = 0) 2N6035G, 2N6038G (V _{CE} = 80 V _{dc} , I _B = 0) 2N6036G, 2N6039G	I _{CEO}	– – –	100 100 100	μA
Collector–Cutoff Current (V _{CE} = 40 V _{dc} , V _{BE(off)} = 1.5 V _{dc}) 2N6034G (V _{CE} = 60 V _{dc} , V _{BE(off)} = 1.5 V _{dc}) 2N6035G, 2N6038G (V _{CE} = 80 V _{dc} , V _{BE(off)} = 1.5 V _{dc}) 2N6036G, 2N6039G (V _{CE} = 40 V _{dc} , V _{BE(off)} = 1.5 V _{dc} , T _C = 125°C) 2N6034G (V _{CE} = 60 V _{dc} , V _{BE(off)} = 1.5 V _{dc} , T _C = 125°C) 2N6035G, 2N6038G (V _{CE} = 80 V _{dc} , V _{BE(off)} = 1.5 V _{dc} , T _C = 125°C) 2N6036G, 2N6039G	I _{CEX}	– – – – – –	100 100 100 500 500 500	μA
Collector–Cutoff Current (V _{CB} = 40 V _{dc} , I _E = 0) 2N6034G (V _{CB} = 60 V _{dc} , I _E = 0) 2N6035G, 2N6038G (V _{CB} = 80 V _{dc} , I _E = 0) 2N6036G, 2N6039G	I _{CBO}	– – –	0.5 0.5 0.5	mA _{dc}
Emitter–Cutoff Current (V _{BE} = 5.0 V _{dc} , I _C = 0)	I _{EBO}	–	2.0	mA _{dc}
ON CHARACTERISTICS				
DC Current Gain (I _C = 0.5 A _{dc} , V _{CE} = 3.0 V _{dc}) (I _C = 2.0 A _{dc} , V _{CE} = 3.0 V _{dc}) (I _C = 4.0 A _{dc} , V _{CE} = 3.0 V _{dc})	h _{FE}	500 750 100	– 15,000 –	–
Collector–Emitter Saturation Voltage (I _C = 2.0 A _{dc} , I _B = 8.0 mA _{dc}) (I _C = 4.0 A _{dc} , I _B = 40 mA _{dc})	V _{CE(sat)}	– –	2.0 3.0	V _{dc}
Base–Emitter Saturation Voltage (I _C = 4.0 A _{dc} , I _B = 40 mA _{dc})	V _{BE(sat)}	–	4.0	V _{dc}
Base–Emitter On Voltage (I _C = 2.0 A _{dc} , V _{CE} = 3.0 V _{dc})	V _{BE(on)}	–	2.8	V _{dc}
DYNAMIC CHARACTERISTICS				
Small–Signal Current–Gain (I _C = 0.75 A _{dc} , V _{CE} = 10 V _{dc} , f = 1.0 MHz)	h _{fe}	25	–	–
Output Capacitance (V _{CB} = 10 V _{dc} , I _E = 0, f = 0.1 MHz) 2N6034G, 2N6035G, 2N6036G 2N6038G, 2N6039G	C _{ob}	– –	200 100	pF

Product parametric performance is indicated in the Electrical Characteristics for the listed test conditions, unless otherwise noted. Product performance may not be indicated by the Electrical Characteristics if operated under different conditions.

*Indicates JEDEC Registered Data.

2N6034G, 2N6035G, 2N6036G (PNP), 2N6038G, 2N6039G (NPN)

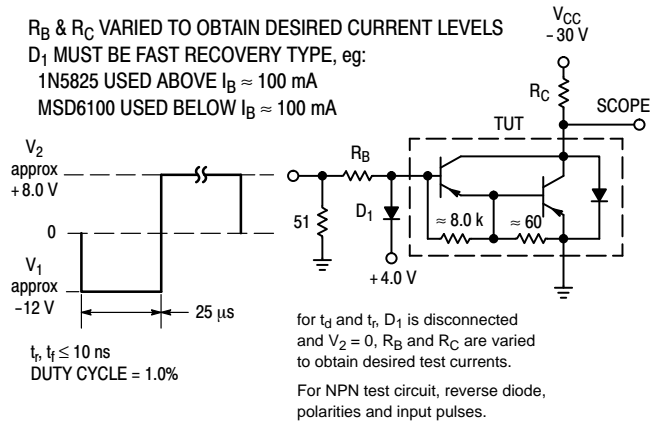

Figure 1. Switching Times Test Circuit

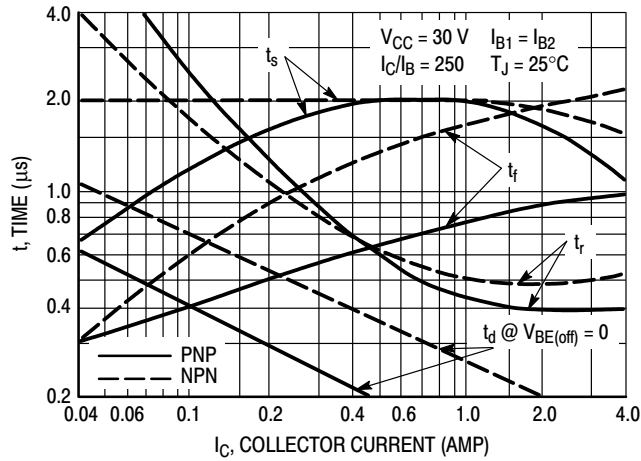

Figure 2. Switching Times

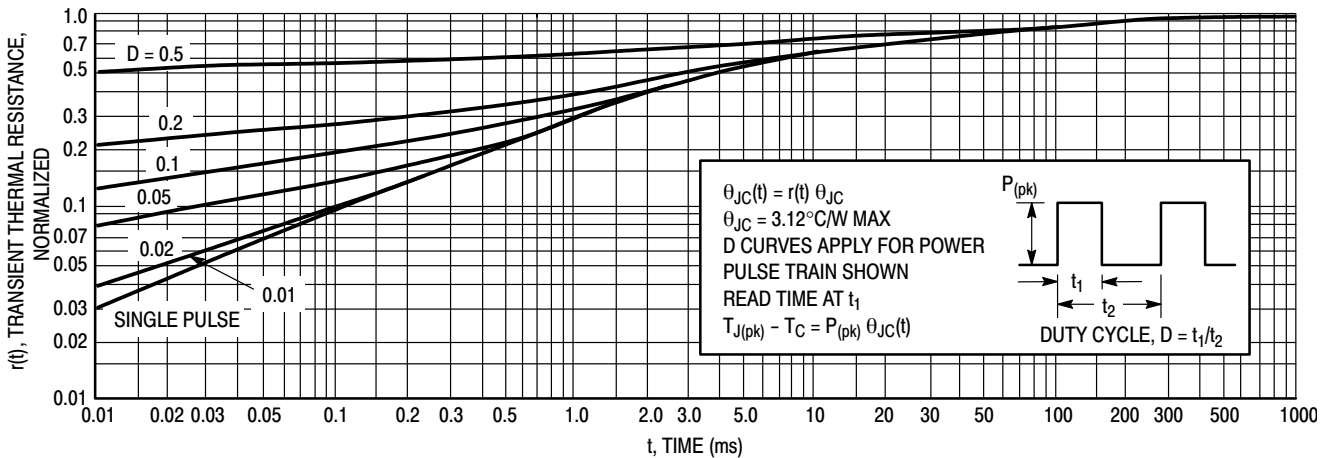

Figure 3. Thermal Response

2N6034G, 2N6035G, 2N6036G (PNP), 2N6038G, 2N6039G (NPN)

ACTIVE-REGION SAFE-OPERATING AREA

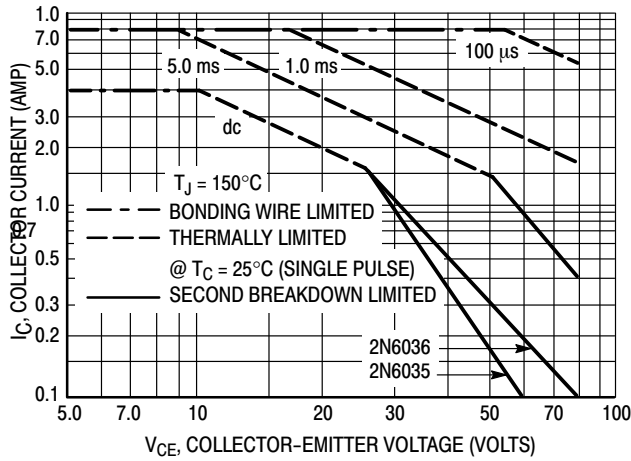

Figure 4. 2N6035, 2N6036

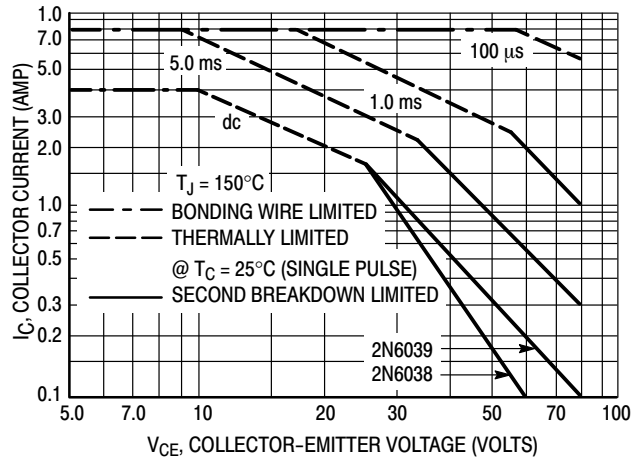

Figure 5. 2N6038, 2N6039

There are two limitations on the power handling ability of a transistor: average junction temperature and second breakdown. Safe operating area curves indicate $I_C - V_{CE}$ limits of the transistor that must be observed for reliable operation; i.e., the transistor must not be subjected to greater dissipation than the curves indicate.

The data of Figures 4 and 5 is based on $T_{J(pk)} = 150^\circ\text{C}$; T_C is variable depending on conditions. Second breakdown pulse limits are valid for duty cycles to 10% provided $T_{J(pk)} < 150^\circ\text{C}$. $T_{J(pk)}$ may be calculated from the data in Figure 3. At high case temperatures, thermal limitations will reduce the power that can be handled to values less than the limitations imposed by second breakdown.

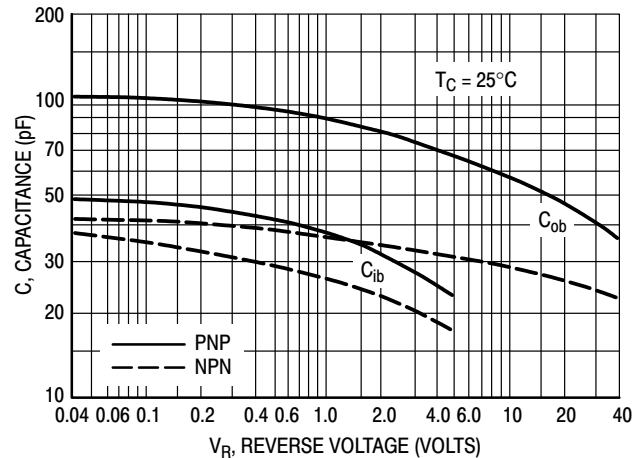
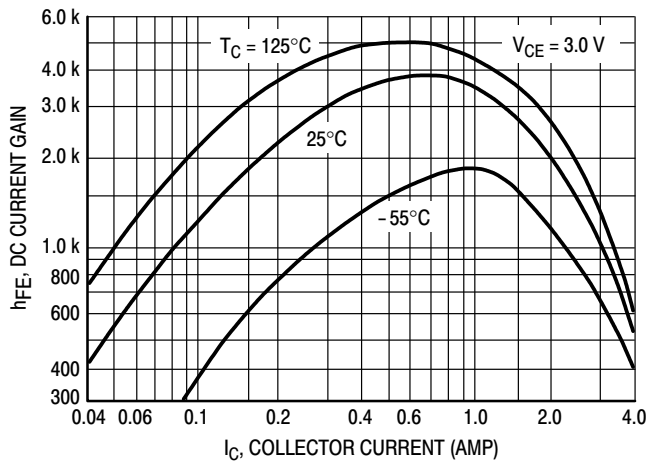

Figure 6. Capacitance

PNP 2N6034, 2N6035, 2N6036



NPN 2N6038, 2N6039

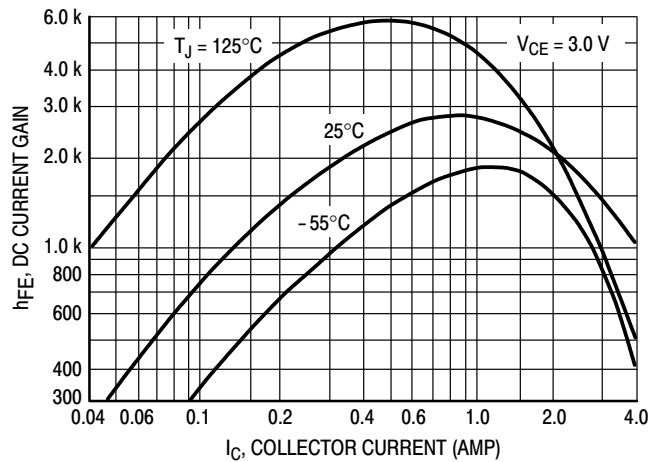

Figure 7. DC Current Gain

2N6034G, 2N6035G, 2N6036G (PNP), 2N6038G, 2N6039G (NPN)

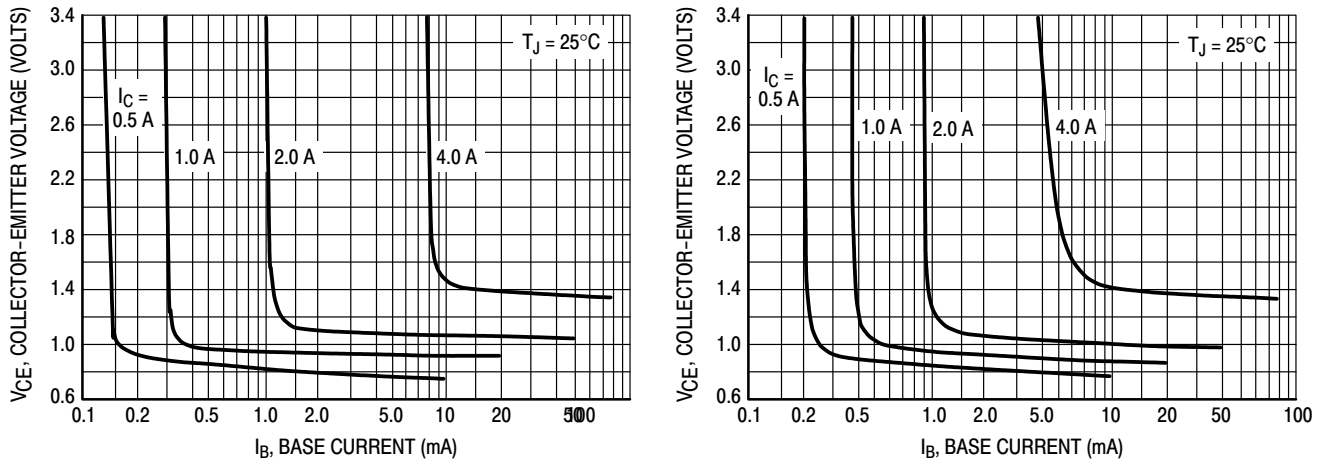

Figure 8. Collector Saturation Region

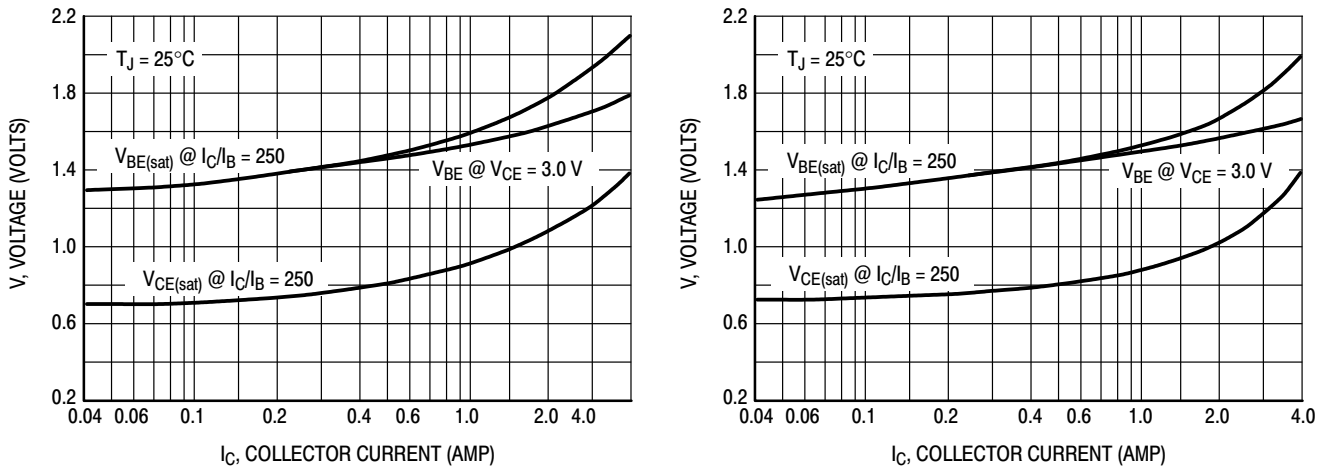

Figure 9. "On" Voltages

ORDERING INFORMATION

Device	Package	Shipping
2N6034G	TO-225 (Pb-Free)	500 Units / Box
2N6035G	TO-225 (Pb-Free)	500 Units / Box
2N6036G	TO-225 (Pb-Free)	500 Units / Box
2N6038G	TO-225 (Pb-Free)	500 Units / Box
2N6039G	TO-225 (Pb-Free)	500 Units / Box

2N6034G, 2N6035G, 2N6036G (PNP), 2N6038G, 2N6039G (NPN)

PACKAGE DIMENSIONS

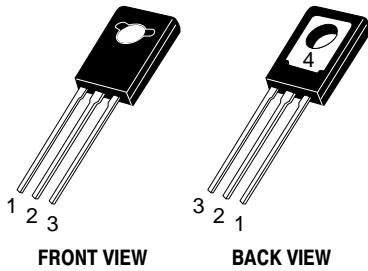

TO-225
CASE 77-09
ISSUE AC

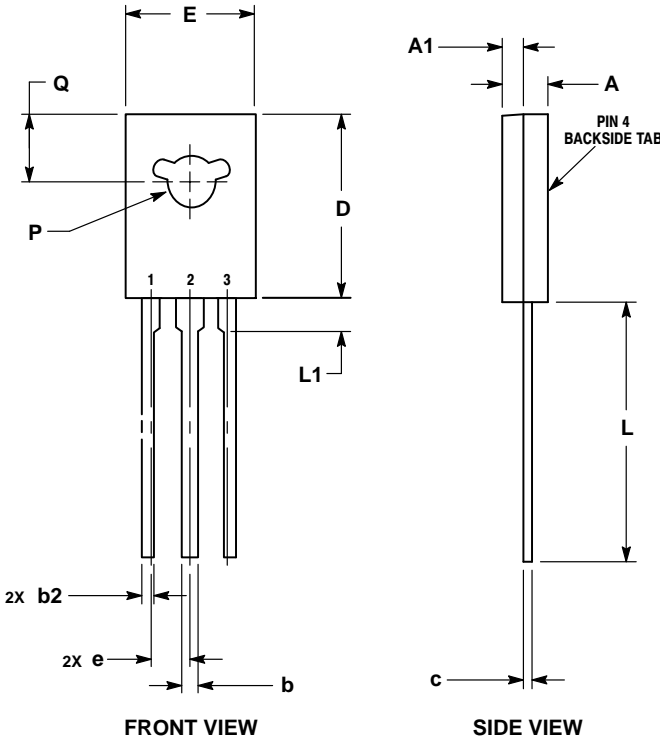

- NOTES:
1. DIMENSIONING AND TOLERANCING PER ASME Y14.5M, 1994.
2. CONTROLLING DIMENSION: MILLIMETERS.
3. NUMBER AND SHAPE OF LUGS OPTIONAL.

DIM	MILLIMETERS	
	MIN	MAX
A	2.40	3.00
A1	1.00	1.50
b	0.60	0.90
b2	0.51	0.88
c	0.39	0.63
D	10.60	11.10
E	7.40	7.80
e	2.04	2.54
L	14.50	16.63
L1	1.27	2.54
P	2.90	3.30
Q	3.80	4.20

- STYLE 1:
PIN 1. EMITTER
2., 4. COLLECTOR
3. BASE

ON Semiconductor and are registered trademarks of Semiconductor Components Industries, LLC (SCILLC). SCILLC owns the rights to a number of patents, trademarks, copyrights, trade secrets, and other intellectual property. A listing of SCILLC's product/patent coverage may be accessed at www.onsemi.com/site/pdf/Patent-Marking.pdf. SCILLC reserves the right to make changes without further notice to any products herein. SCILLC makes no warranty, representation or guarantee regarding the suitability of its products for any particular purpose, nor does SCILLC assume any liability arising out of the application or use of any product or circuit, and specifically disclaims any and all liability, including without limitation special, consequential or incidental damages. "Typical" parameters which may be provided in SCILLC data sheets and/or specifications can and do vary in different applications and actual performance may vary over time. All operating parameters, including "Typicals" must be validated for each customer application by customer's technical experts. SCILLC does not convey any license under its patent rights nor the rights of others. SCILLC products are not designed, intended, or authorized for use as components in systems intended for surgical implant into the body, or other applications intended to support or sustain life, or for any other application in which the failure of the SCILLC product could create a situation where personal injury or death may occur. Should Buyer purchase or use SCILLC products for any such unintended or unauthorized application, Buyer shall indemnify and hold SCILLC and its officers, employees, subsidiaries, affiliates, and distributors harmless against all claims, costs, damages, and expenses, and reasonable attorney fees arising out of, directly or indirectly, any claim of personal injury or death associated with such unintended or unauthorized use, even if such claim alleges that SCILLC was negligent regarding the design or manufacture of the part. SCILLC is an Equal Opportunity/Affirmative Action Employer. This literature is subject to all applicable copyright laws and is not for resale in any manner.

PUBLICATION ORDERING INFORMATION

LITERATURE FULFILLMENT:
Literature Distribution Center for ON Semiconductor
P.O. Box 5163, Denver, Colorado 80217 USA
Phone: 303-675-2175 or 800-344-3860 Toll Free USA/Canada
Fax: 303-675-2176 or 800-344-3867 Toll Free USA/Canada
Email: orderlit@onsemi.com

N. American Technical Support: 800-282-9855 Toll Free
USA/Canada
Europe, Middle East and Africa Technical Support:
Phone: 421 33 790 2910
Japan Customer Focus Center
Phone: 81-3-5817-1050

ON Semiconductor Website: www.onsemi.com
Order Literature: <http://www.onsemi.com/orderlit>
For additional information, please contact your local Sales Representative

Mouser Electronics

Authorized Distributor

Click to View Pricing, Inventory, Delivery & Lifecycle Information:

[ON Semiconductor:](#)

[2N6034](#) [2N6034G](#) [2N6035](#) [2N6035G](#) [2N6036](#) [2N6036G](#) [2N6038](#) [2N6038G](#) [2N6039](#) [2N6039G](#)