

IEC Appliance Inlet C14 or C18 with recessed Circuit Breaker TA45



See below:  
[Approvals and Compliances](#)

**Description**

- Panel mount :  
 Screw-on version from front or rear side, snap-in version from front side
- 2 Functions :  
 Appliance Inlet protection class I or II , circuit breaker type TA45 2-pole
- Quick connect terminals 6.3 x 0.8 mm

**Characteristics**

- All single elements are already wired
- Circuit Breaker non-illuminated or illuminated
- Suitable for use in equipment according to IEC/UL 60950

**Other versions on request**

- Unwired versions
- Other rocker marking
- Variant with notch for V-Lock mating Cordsets

**References**

Alternative: version with line filter [DF12](#)  
 Substitute for type [6145](#)

**Weblinks**

[pdf datasheet](#), [html-datasheet](#), [General Product Information](#), [Distributor-Stock-Check](#), [Accessories](#), [Detailed request for product](#), [Microsite](#)

Newly available variants corresponding to V-Lock mating cordset. The connector is equipped with a notch intended for use with the latching cordset. The cord latching system prevents against accidental removal of the cordset.

**Technical Data**

Ratings IEC	10A / 250VAC; 50Hz	appliance inlet/-outlet	C14 / C18 acc. to IEC 60320-1, UL 60320-1, CSA C22.2 no. 60320-1 (for cold conditions) pin-temperature 70 °C, 10A, Protection Class I or II
Ratings UL/CSA	15A / 250VAC; 60Hz	Circuit Breakers	Acc. IEC/EN 60934, UL 1077, CSA 22.2 no. 235 2-pole rocker switch, illuminated or non-illuminated. Optional with undervoltage- or remote trip release Short circuit capacity Icn: at In < 3A/240VAC : 10 x In at In ≥ 3A/240VAC : 300A
Dielectric Strength	> 2.5kVAC between L-N > 3kVAC between L/N-PE (1 min/50Hz)		
Allowable Operation Temperature	-10°C to 55°C		
IP-Protection	from front side IP 40 acc. to IEC 60529		
Insulation cover	Suitable for appliances with protection class I or II acc. to IEC 61140		
Terminal	Quick connect terminals 6.3 x 0.8 mm		
Panel Thickness S	Screw: max 8 mm Mounting screw torque max 0.5Nm Snap-in: 1/1.5/2/2.5/3 mm		
Material: Housing	Thermoplastic, black, UL 94V-0		

**Approvals and Compliances**

Detailed information on product approvals, code requirements, usage instructions and detailed test conditions can be looked up in [Details about Approvals](#)

**Approvals**



The approval mark is used by the testing authorities to certify compliance with the safety requirements placed on electronic products.

Approval Reference Type: DF11

Approval Logo	Certificates	Certification Body	Description
	VDE Approvals	VDE	Certificate Number: 40011305
	UL Approvals	UL	UL File Number: E96454

## Product standards

Product standards that are referenced

Organization	Design	Standard	Description
	Designed according to	IEC 60320-1	Appliance couplers for household and similar general purposes
	Designed according to	UL 60320-1	Standard for Attachment Plugs and Receptacles
	Designed according to	CSA C22.2 no. 60320-1	General Use Receptacles, Attachment Plugs, and Similar Wiring Devices





## Application standards

Application standards where the product can be used

Organization	Design	Standard	Description
	Designed for applications acc.	IEC/UL 60950	IEC 60950-1 includes the basic requirements for the safety of information technology equipment.

## Compliances

The product complies with following Guide Lines

Identification	Details	Initiator	Description
	CE declaration of conformity	SCHURTER AG	The CE marking declares that the product complies with the applicable requirements laid down in the harmonisation of Community legislation on its affixing in accordance with EU Regulation 765/2008.
	RoHS	SCHURTER AG	EU Directive RoHS 2011/65/EU
	China RoHS	SCHURTER AG	The law SJ / T 11363-2006 (China RoHS) has been in force since 1 March 2007. It is similar to the EU directive RoHS.
	REACH	SCHURTER AG	On 1 June 2007, Regulation (EC) No 1907/2006 on the Registration, Evaluation, Authorization and Restriction of Chemicals 1 (abbreviated as "REACH") entered into force.
	MicrositeV-Lock	SCHURTER AG	V-Lock system are based on a matching plug-dose combination. The connector is equipped with a notch intended for use with the latching cordset. The cord latching system prevents against accidental removal of the cordset.

## Dimensions [mm]

Screw-on mounting

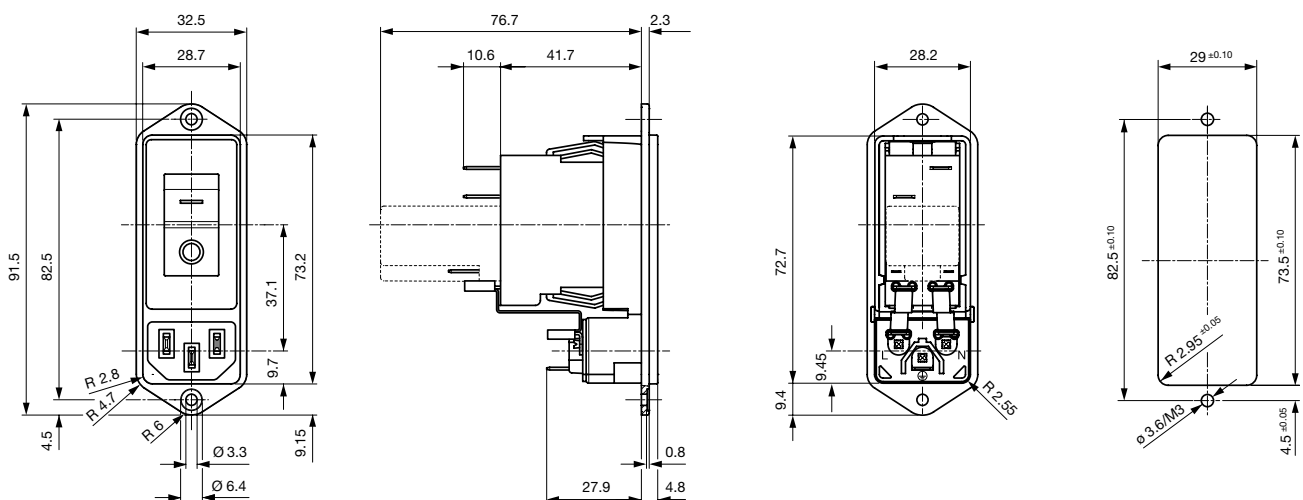

Snap-in version

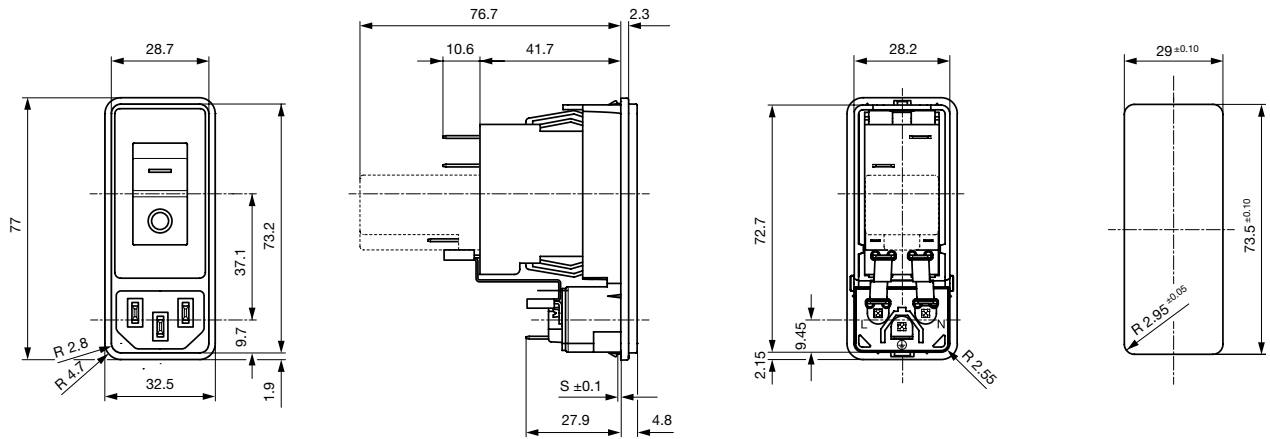

\* --- Version TA45 with undervoltage release

Diagrams

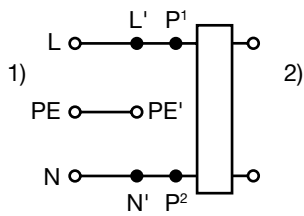

- 1) Line
- 2) Load

**Table 1 Selection for type TA45**

Order example



- Circuit Breaker of Equipment
  - 2-pole, rocker actuated
  - Quick connect terminal
- Other types on request

**Diagram**

Thermal overload protection

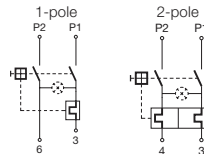

Without illumination

**ABT**

**ABD**

With illumination

220...240 V  
110...120 V

**A12**  
**A14**

**A32**  
**A34**

**Colours**

**Switch front**

- W** black
- B** black
- 6** black

**Rocker**

- white
- black
- 
- orange transp.

**ABT** **W** **F** **150** **C0**

**Rocker legend**

Surface	Illustration	Colour of print	Surface	Illustration	Colour of print
<b>F</b> embossed / Relief	— ○		<b>M</b> printed	— ○	black
<b>H</b> printed / bedruckt	ON OFF	white / weiss	<b>P</b> printed	I ○	white
<b>K</b> printed / bedruckt	ON OFF	black / schwarz	<b>R</b> printed	I ○	black
<b>L</b> printed / bedruckt	— ○	white / weiss			

Position of the rocker legend  
e.g F

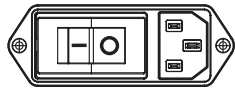

**Rated current circuit breaker of equipment**

$I_n$	Code	$I_n$	Code	$I_n$	Code	$I_n$	Code
0,1	<b>J01</b>	1,3	<b>J13</b>	2,8	<b>J28</b>	10,0	<b>100</b>
0,2	<b>J02</b>	1,4	<b>J14</b>	3,0	<b>030</b>	11,0	<b>110</b>
0,3	<b>J03</b>	1,5	<b>J15</b>	3,5	<b>035</b>	12,0	<b>120</b>
0,4	<b>J04</b>	1,6	<b>J16</b>	4,0	<b>040</b>	13,0	<b>130</b>
0,5	<b>J05</b>	1,7	<b>J17</b>	4,5	<b>045</b>	14,0	<b>140</b>
0,6	<b>J06</b>	1,8	<b>J18</b>	5,0	<b>050</b>	15,0	<b>150</b>
0,7	<b>J07</b>	1,9	<b>J19</b>	6,0	<b>060</b>	20,0	<b>200</b>
0,8	<b>J08</b>	2,0	<b>J20</b>	6,5	<b>065</b>		
0,9	<b>J09</b>	2,1	<b>J21</b>	7,0	<b>070</b>		
1,0	<b>J10</b>	2,2	<b>J22</b>	7,5	<b>075</b>		
1,1	<b>J11</b>	2,3	<b>J23</b>	8,0	<b>080</b>		
1,2	<b>J12</b>	2,5	<b>J25</b>	9,0	<b>090</b>		

**Without release: code C0**

**Undervoltage release**

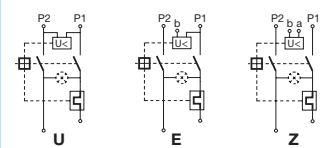

•	•	•
•	•	•
•	•	•

**Remote trip release**

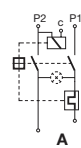

Code	Rated voltage $U_n$
•	<b>2</b> 240 V AC
•	<b>3</b> 230 V AC
•	<b>4</b> 120 V AC

**Technical data (continued)**  
**Circuit breaker**

Tripping characteristics  
 $I_n < 3 A$

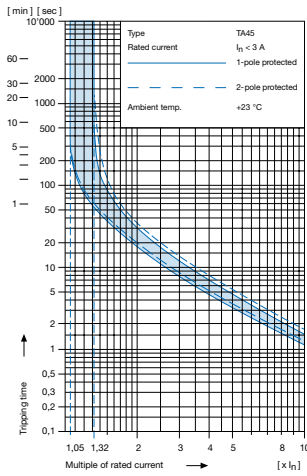

Tripping characteristics  
 $I_n \geq 3 \dots \leq 15 A$

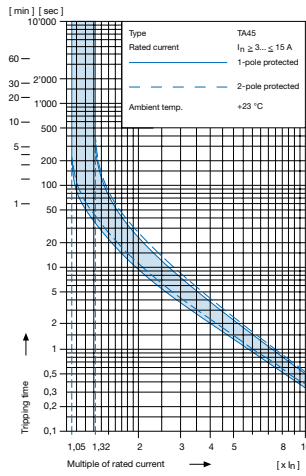

**Effect of ambient temperature 1)**

The unit is calibrated for an ambient temperature of +23 °C. To determine the rated current for a lower or higher ambient temperature, use a correction factor from the table below.

* Ambient temperature [°C]	Correction factor
-10	0,89
- 5	0,91
0	0,92
+23	1,00
+30	1,03
+40	1,08
+55	1,16

\* Temperature must be measured at the rear of the breaker next to the terminals after equipment operating temperature has been reached.

**1) Example**

Rated current at +23 °C	6,0 A
Ambient temperature	+40 °C
Correction factor	1,08
Chosen rated current at + 40 °C ambient temperature	6 A x 1,08 = 6,5 A

**Configuratorcode (example)**

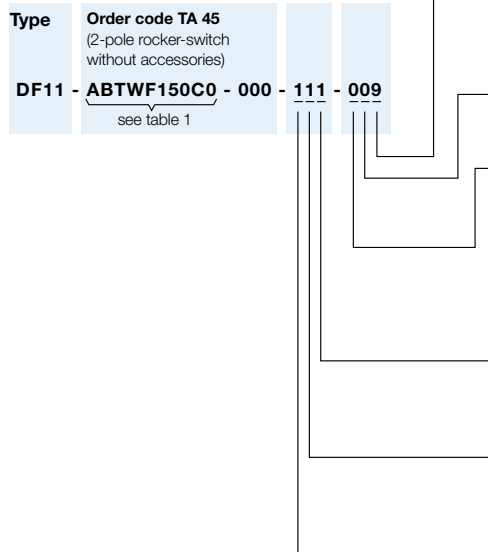

**Optional Variants**

- 0 standard
- 9 V-Lock

**Colour**

- 0 black

**Mounting**

- 0 Screw mounting
- 1 Snap-in mounting s = 1.0 mm
- 2 Snap-in mounting s = 1.5 mm
- 3 Snap-in mounting s = 2.0 mm
- 4 Snap-in mounting s = 2.5 mm
- 5 Snap-in mounting s = 3.0 mm

**Terminal PE**

- 0 without terminal (PCI)
- 1 Quick-connect terminal 6.3x0.8 mm

**Terminal N**

- 1 Quick-connect terminals 6.3x0.8mm, without connection to TA45
- 3 connection to TA45 non insulated

**Terminal L**

- 1 Quick-connect terminals 6.3x0.8mm, without connection to TA45
- 3 connection to TA45 non insulated

**Packaging unit** 20 Pcs

## Accessories

### Description

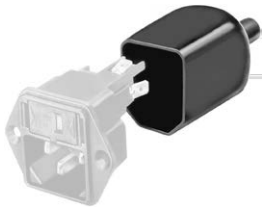

Assorted Covers  
Rear Cover

## Mating Outlets/Connectors

### Category / Description

#### Appliance Outlet Overview complete



IEC Appliance Outlet F, Screw-on Mounting, Front Side, Solder Terminal	4787
IEC Appliance Outlet F, Snap-in Mounting, Front Side, Solder or Quick-connect Terminal	4788
IEC Appliance Outlet F or H, Screw-on Mounting, Front Side, Solder, PCB or Quick-connect Terminal	5091

Appliance Outlet further types to DF11

#### Connector Overview complete



4782 Mounting: Power Cord, 3 x 1 mm <sup>2</sup> / 3 x 18 AWG, Cable, Connector: IEC C13	4782
4785 Mounting: Power Cord, 3 x 1 mm <sup>2</sup> / 3 x 18 AWG, Cable, Connector: IEC C13	4785
4300-06 Mounting: Power Cord, 3 x 1 mm <sup>2</sup> / 3 x 18 AWG, Cable, Connector: IEC C13	4300-06
IEC Connector C15 for hot conditions 120°C, Rewireable, Straight	4781
IEC Connector C15 for hot conditions 120°C, Rewireable, Angled	4784

Connector further types to DF11

...

## Mating Outlets/Connectors shuttered



#### Power Cord Overview complete

VAC13KS, Overview, diverse Connector IEC C13, cord end:	VAC13KS
---	---------

Power Cord further types to DF11

# Mouser Electronics

Authorized Distributor

Click to View Pricing, Inventory, Delivery & Lifecycle Information:

## Schurter:

[DF11.2078.0010.01](#) [DF11.1477.0012.02](#) [DF11.0470.0010.01](#) [DF11.0885.0010.01](#) [DF11.1066.0012.01](#)  
[DF11.1477.0010.01](#) [DF11.1486.0010.02](#) [DF11.1682.0010.01](#) [DF11.1926.0010.01](#) [DF11.2217.0010.01](#)  
[DF11.2370.0010.02](#) [DF11.3065.0010.01](#) [DF11.3670.0010.01](#) [DF11.3697.0010.01](#) [DF11.3711.0013.01](#)  
[DF11.3714.0013.01](#) [DF11.3714.0013.019](#) [DF11.3751.0010.01](#) [DF11.1089.0010.01](#) [DF11.1089.0010.02](#)  
[DF11.2173.0012.01](#) [DF11.0559.0010.01](#) [DF11.0879.0014.02](#) [DF11.1358.0014.02](#) [DF11.1477.0013.01](#)  
[DF11.1698.0010.01](#) [DF11.2309.0010.01](#) [DF11.2347.0012.01](#) [DF11.2430.0012.01](#) [DF11.3714.0010.019](#)  
[DF11.3833.0014.02](#) [DF11.3852.0012.01](#) [DF11.1927.0013.01](#) [DF11.3938.0010.019](#) [3-103-454](#)