

## FEATURES

- Gain of 25 Stable
- 1GHz Gain Bandwidth
- 400V/ $\mu$ s Slew Rate
- 2.6nV/ $\sqrt{\text{Hz}}$  Input Noise Voltage
- 50V/mV Minimum DC Gain,  $R_L = 500\Omega$
- 1mV Maximum Input Offset Voltage
- $\pm 12\text{V}$  Minimum Output Swing into 500 $\Omega$
- Wide Supply Range  $\pm 2.5\text{V}$  to  $\pm 15\text{V}$
- 7mA Supply Current
- 100ns Settling Time to 0.1%, 10V Step
- Drives All Capacitive Loads

## APPLICATIONS

- Wideband Amplifiers
- Buffers
- Active Filters
- Video and RF Amplification
- Cable Drivers
- Data Acquisition Systems

## DESCRIPTION

The LT1226 is a low noise, very high speed operational amplifier with excellent DC performance. The LT1226 features low input offset voltage and high DC gain. The circuit is a single gain stage with outstanding settling characteristics. The fast settling time makes the circuit an ideal choice for data acquisition systems. The output is capable of driving a 500 $\Omega$  load to  $\pm 12\text{V}$  with  $\pm 15\text{V}$  supplies and a 150 $\Omega$  load to  $\pm 3\text{V}$  on  $\pm 5\text{V}$  supplies. The circuit is also capable of driving large capacitive loads which makes it useful in buffer or cable driver applications.

The LT1226 is a member of a family of fast, high performance amplifiers that employ Linear Technology Corporation's advanced bipolar complementary processing.

## TYPICAL APPLICATION

Photodiode Preamplifier,  $A_V = 5.1\text{k}\Omega$ ,  $\text{BW} = 15\text{MHz}$

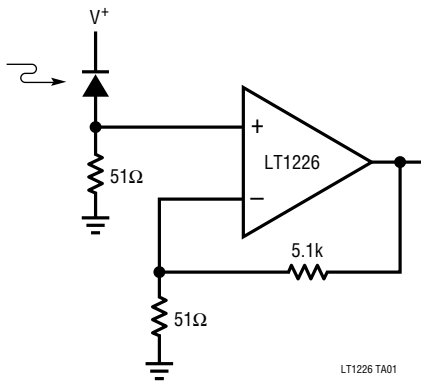

Gain of +25 Pulse Response

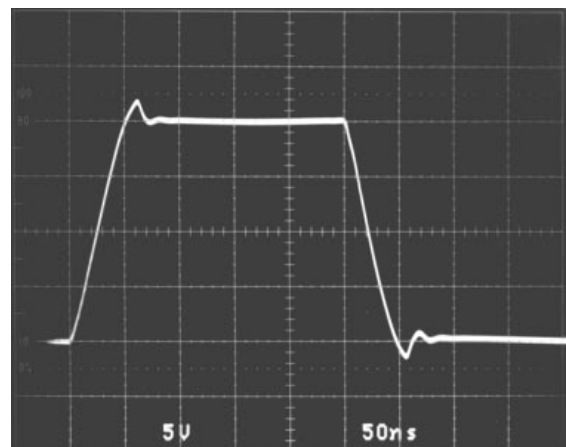

## ABSOLUTE MAXIMUM RATINGS

Total Supply Voltage ( $V^+$ to $V^-$ ) .....	36V
Differential Input Voltage .....	$\pm 6V$
Input Voltage .....	$\pm V_S$
Output Short Circuit Duration (Note 1) .....	Indefinite
Operating Temperature Range	
LT1226C .....	0°C to 70°C
Maximum Junction Temperature	
Plastic Package .....	150°C
Storage Temperature Range .....	- 65°C to 150°C
Lead Temperature (Soldering, 10 sec.) .....	300°C

## PACKAGE/ORDER INFORMATION

	ORDER PART NUMBER
	LT1226CN8 LT1226CS8
	S8 PART MARKING
	1226

## ELECTRICAL CHARACTERISTICS $V_S = \pm 15V$ , $T_A = 25^\circ C$ , $V_{CM} = 0V$ unless otherwise noted.

SYMBOL	PARAMETER	CONDITIONS	MIN	TYP	MAX	UNITS
$V_{OS}$	Input Offset Voltage	(Note 2)		0.3	1.0	mV
$I_{OS}$	Input Offset Current			100	400	nA
$I_B$	Input Bias Current			4	8	$\mu A$
$e_n$	Input Noise Voltage	$f = 10kHz$		2.6		$nV/\sqrt{Hz}$
$i_n$	Input Noise Current	$f = 10kHz$		1.5		$pA/\sqrt{Hz}$
$R_{IN}$	Input Resistance	$V_{CM} = \pm 12V$ Differential	24	40 15		M $\Omega$ k $\Omega$
$C_{IN}$	Input Capacitance			2		pF
	Input Voltage Range +		12	14		V
	Input Voltage Range -			-13	-12	V
CMRR	Common-Mode Rejection Ratio	$V_{CM} = \pm 12V$	94	103		dB
PSRR	Power Supply Rejection Ratio	$V_S = \pm 5V$ to $\pm 15V$	94	110		dB
$A_{VOL}$	Large Signal Voltage Gain	$V_{OUT} = \pm 10V$ , $R_L = 500\Omega$	50	150		V/mV
$V_{OUT}$	Output Swing	$R_L = 500\Omega$	12.0	13.3		$\pm V$
$I_{OUT}$	Output Current	$V_{OUT} = \pm 12V$	24	40		mA
SR	Slew Rate	(Note 3)	250	400		V/ $\mu s$
	Full Power Bandwidth	10V Peak, (Note 4)		6.4		MHz
GBW	Gain Bandwidth	$f = 1MHz$		1		GHz
$t_r$ , $t_f$	Rise Time, Fall Time	$A_{VCL} = +25$ , 10% to 90%, 0.1V		5.5		ns
	Overshoot	$A_{VCL} = +25$ , 0.1V		35		%
	Propagation Delay	50% $V_{IN}$ to 50% $V_{OUT}$		5.5		ns
$t_s$	Settling Time	10V Step, 0.1%, $A_V = -25$		100		ns
	Differential Gain	$f = 3.58MHz$ , $A_V = +25$ , $R_L = 150\Omega$		0.7		%
	Differential Phase	$f = 3.58MHz$ , $A_V = +25$ , $R_L = 150\Omega$		0.6		Deg
$R_O$	Output Resistance	$A_{VCL} = +25$ , $f = 1MHz$		3.1		$\Omega$
$I_S$	Supply Current			7	9	mA

**ELECTRICAL CHARACTERISTICS**  $V_S = \pm 5V$ ,  $T_A = 25^\circ C$ ,  $V_{CM} = 0V$  unless otherwise noted.

SYMBOL	PARAMETER	CONDITIONS	MIN	TYP	MAX	UNITS
$V_{OS}$	Input Offset Voltage	(Note 2)		1.0	1.4	mV
$I_{OS}$	Input Offset Current			100	400	nA
$I_B$	Input Bias Current			4	8	$\mu A$
	Input Voltage Range +		2.5	4		V
	Input Voltage Range -			-3	-2.5	V
CMRR	Common-Mode Rejection Ratio	$V_{CM} = \pm 2.5V$	94	103		dB
$A_{VOL}$	Large Signal Voltage Gain	$V_{OUT} = \pm 2.5V$ , $R_L = 500\Omega$ $V_{OUT} = \pm 2.5V$ , $R_L = 150\Omega$	50	100 75		V/mV V/mV
$V_{OUT}$	Output Voltage	$R_L = 500\Omega$ $R_L = 150\Omega$	3.0 3.0	3.7 3.3		$\pm V$ $\pm V$
$I_{OUT}$	Output Current	$V_{OUT} = \pm 3V$	20	40		mA
SR	Slew Rate	(Note 3)		250		V/ $\mu s$
	Full Power Bandwidth	3V Peak, (Note 4)		13.3		MHz
GBW	Gain Bandwidth	$f = 1MHz$		700		MHz
$t_r, t_f$	Rise Time, Fall Time	$A_{VCL} = +25$ , 10% to 90%, 0.1V		8		ns
	Overshoot	$A_{VCL} = +25$ , 0.1V		25		%
	Propagation Delay	50% $V_{IN}$ to 50% $V_{OUT}$		8		ns
$t_s$	Settling Time	-2.5V to 2.5V, 0.1%, $A_V = -24$		60		ns
$I_S$	Supply Current			7	9	mA

**ELECTRICAL CHARACTERISTICS**  $0^\circ C \leq T_A \leq 70^\circ C$ ,  $V_{CM} = 0V$  unless otherwise noted.

SYMBOL	PARAMETER	CONDITIONS	MIN	TYP	MAX	UNITS
$V_{OS}$	Input Offset Voltage	$V_S = \pm 15V$ , (Note 2) $V_S = \pm 5V$ , (Note 2)		0.3 1.0	1.3 1.8	mV mV
	Input $V_{OS}$ Drift			6		$\mu V/^\circ C$
$I_{OS}$	Input Offset Current	$V_S = \pm 15V$ and $V_S = \pm 5V$		100	600	nA
$I_B$	Input Bias Current	$V_S = \pm 15V$ and $V_S = \pm 5V$		4	9	$\mu A$
CMRR	Common-Mode Rejection Ratio	$V_S = \pm 15V$ , $V_{CM} = \pm 12V$ and $V_S = \pm 5V$ , $V_{CM} = \pm 2.5V$	92	103		dB
PSRR	Power Supply Rejection Ratio	$V_S = \pm 5V$ to $\pm 15V$	92	110		dB
$A_{VOL}$	Large Signal Voltage Gain	$V_S = \pm 15V$ , $V_{OUT} = \pm 10V$ , $R_L = 500\Omega$ $V_S = \pm 5V$ , $V_{OUT} = \pm 2.5V$ , $R_L = 500\Omega$	35 35	150 100		V/mV V/mV
$V_{OUT}$	Output Swing	$V_S = \pm 15V$ , $R_L = 500\Omega$ $V_S = \pm 5V$ , $R_L = 500\Omega$ or $150\Omega$	12.0 3.0	13.3 3.3		$\pm V$ $\pm V$
$I_{OUT}$	Output Current	$V_S = \pm 15V$ , $V_{OUT} = \pm 12V$ $V_S = \pm 5V$ , $V_{OUT} = \pm 3V$	24 20	40 40		mA mA
SR	Slew Rate	$V_S = \pm 15V$ , (Note 3)	250	400		V/ $\mu s$
$I_S$	Supply Current	$V_S = \pm 15V$ and $V_S = \pm 5V$		7	10.5	mA

**Note 1:** A heat sink may be required to keep the junction temperature below absolute maximum when the output is shorted indefinitely.

**Note 2:** Input offset voltage is tested with automated test equipment in <1 second.

**Note 3:** Slew rate is measured between  $\pm 10V$  on an output swing of  $\pm 12V$  on  $\pm 15V$  supplies, and  $\pm 2V$  on an output swing of  $\pm 3.5V$  on  $\pm 5V$  supplies.

**Note 4:** Full power bandwidth is calculated from the slew rate measurement:  $FPBW = SR/2\pi V_p$ .

# TYPICAL PERFORMANCE CHARACTERISTICS

**Input Common Mode Range vs Supply Voltage**

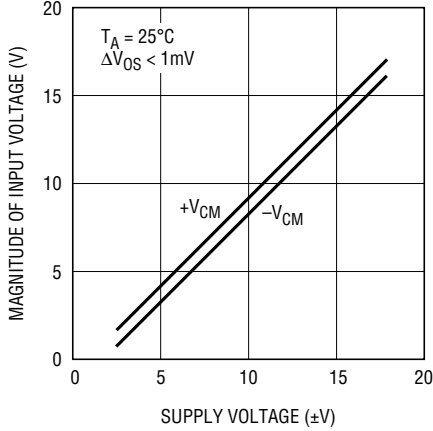

LT1226 TPC01

**Supply Current vs Supply Voltage**

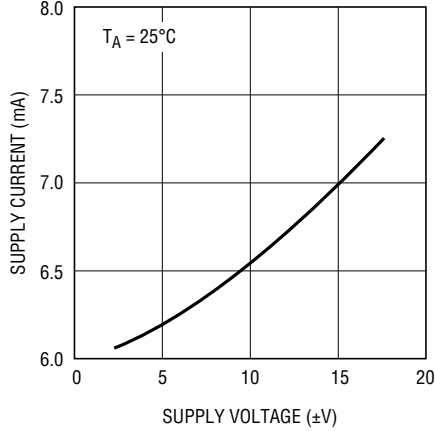

LT1226 TPC02

**Output Voltage Swing vs Supply Voltage**

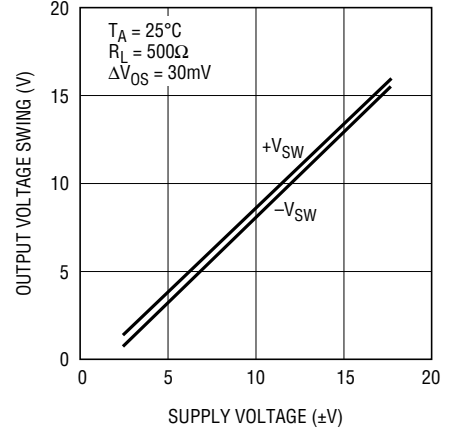

LT1226 TPC03

**Output Voltage Swing vs Resistive Load**

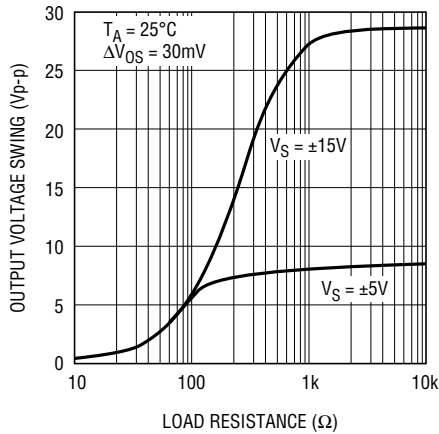

LT1226 TPC04

**Input Bias Current vs Input Common Mode Voltage**

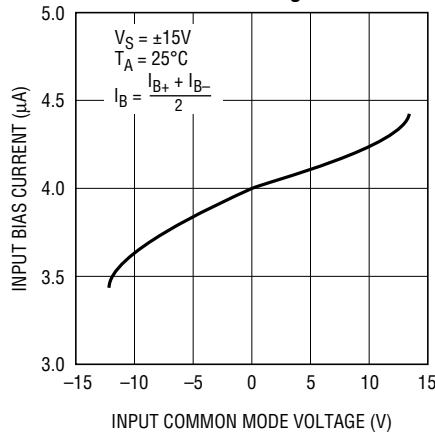

LT1226 TPC05

**Open Loop Gain vs Resistive Load**

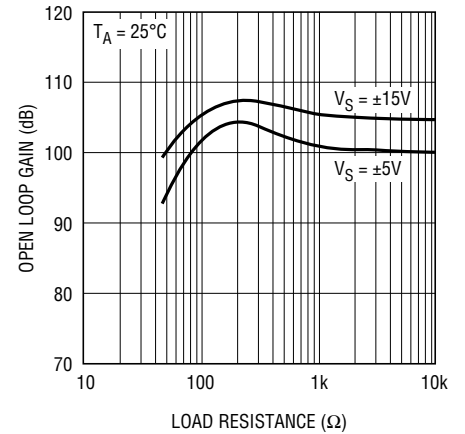

LT1226 TPC06

**Supply Current vs Temperature**

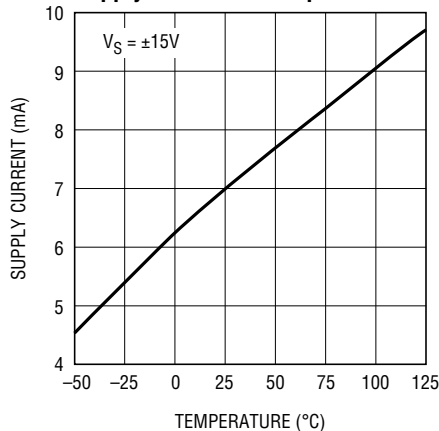

LT1226 TPC07

**Input Bias Current vs Temperature**

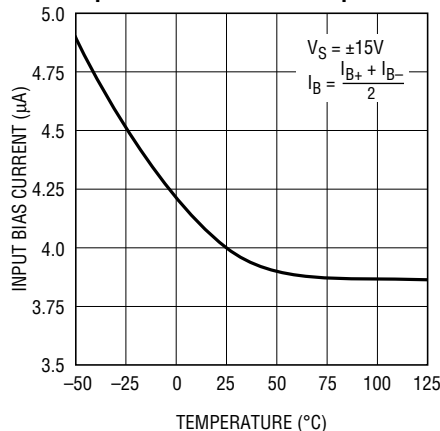

LT1226 TPC08

**Output Short Circuit Current vs Temperature**

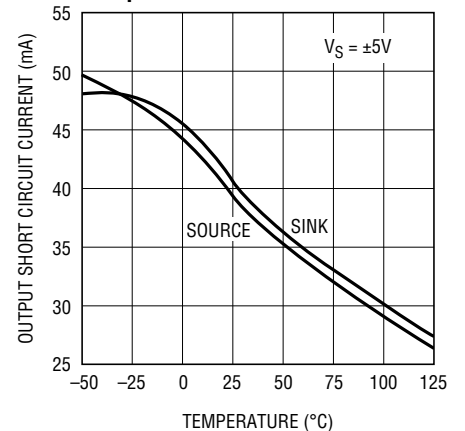

LT1226 TPC09

# TYPICAL PERFORMANCE CHARACTERISTICS

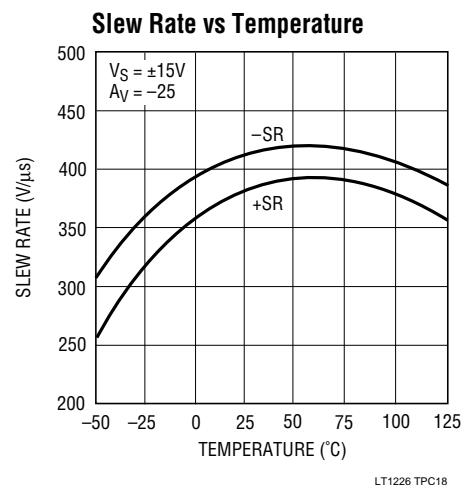
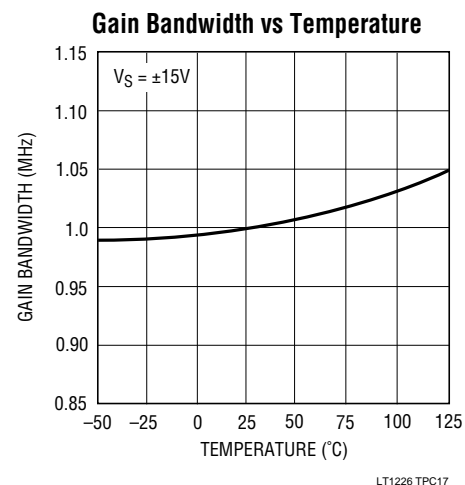
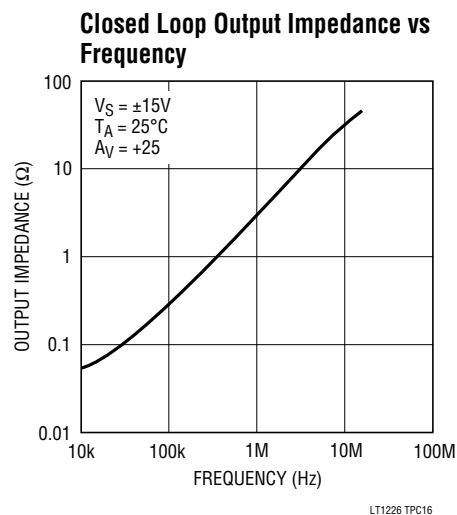
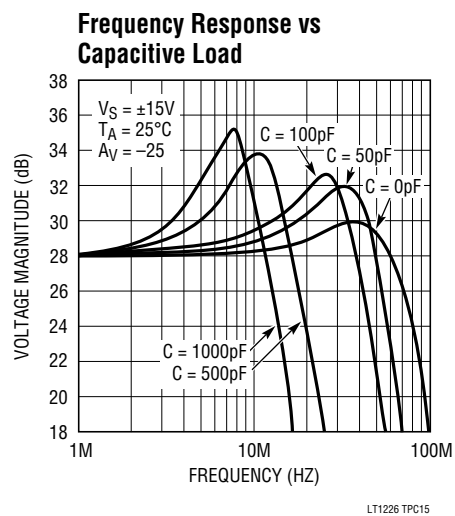
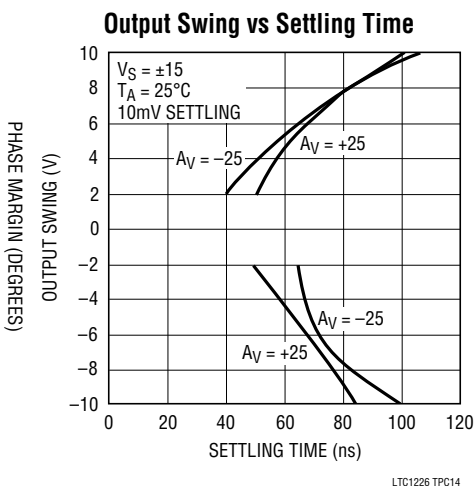
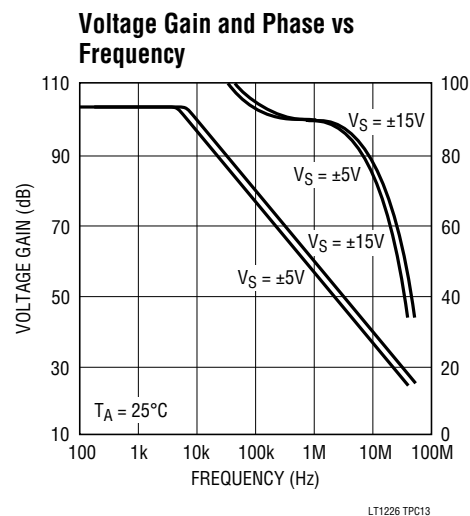
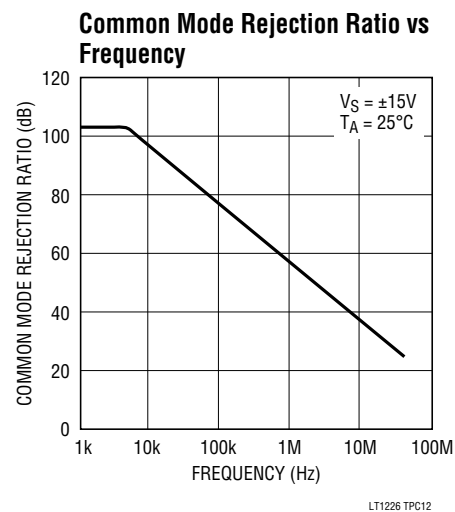
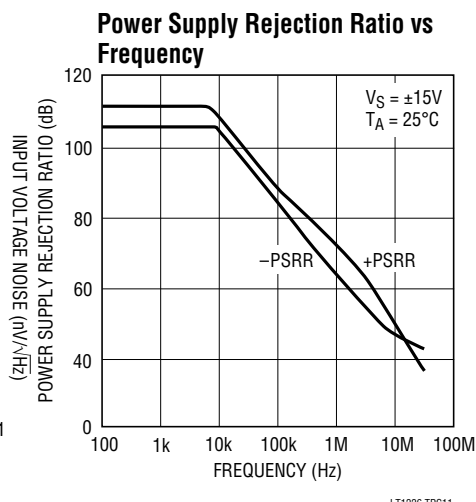
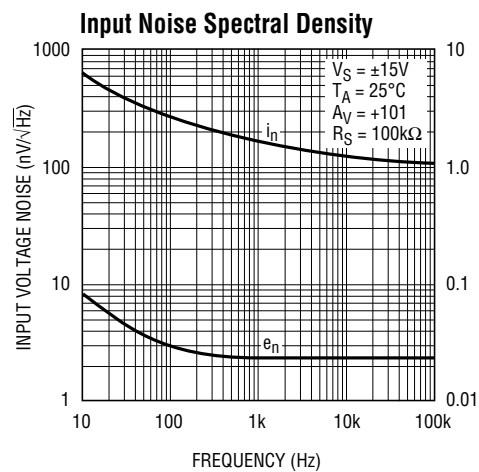

## APPLICATIONS INFORMATION

The LT1226 may be inserted directly into HA2541, HA2544, AD847, EL2020 and LM6361 applications, provided that the amplifier configuration is a noise gain of 25 or greater, and the nulling circuitry is removed. The suggested nulling circuit for the LT1226 is shown below.

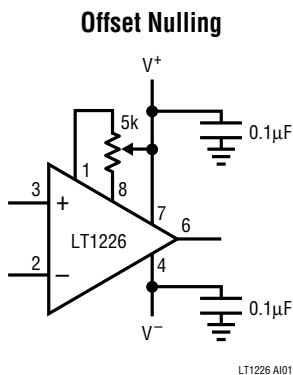

### Layout and Passive Components

As with any high speed operational amplifier, care must be taken in board layout in order to obtain maximum performance. Key layout issues include: use of a ground plane, minimization of stray capacitance at the input pins, short lead lengths, RF-quality bypass capacitors located close to the device (typically 0.01µF to 0.1µF), and use of low ESR bypass capacitors for high drive current applications (typically 1µF to 10µF tantalum). Sockets should be avoided when maximum frequency performance is required, although low profile sockets can provide reasonable performance up to 50MHz. For more details see Design Note 50. Feedback resistors greater than 5kΩ are not recommended because a pole is formed with the input capacitance which can cause peaking. If feedback resistors greater than 5kΩ are used, a parallel capacitor of 5pF to 10pF should be used to cancel the input pole and optimize dynamic performance.

### Transient Response

The LT1226 gain bandwidth is 1GHz when measured at 1MHz. The actual frequency response in a gain of +25 is considerably higher than 40MHz due to peaking caused by a second pole beyond the gain of 25 crossover point. This is reflected in the small signal transient response. Higher noise gain configurations exhibit less overshoot as seen in the inverting gain of 25 response.

Small Signal,  $A_V = +25$

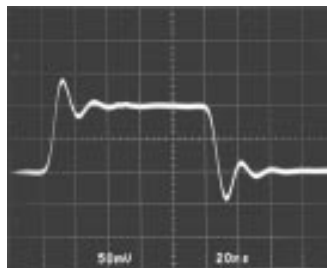

Small Signal,  $A_V = -25$

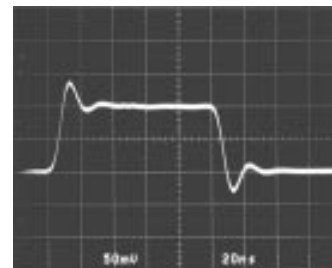

LT1226 A102

The large signal response in both inverting and noninverting gain shows symmetrical slewing characteristics. Normally the noninverting response has a much faster rising edge due to the rapid change in input common mode voltage which affects the tail current of the input differential pair. Slew enhancement circuitry has been added to the LT1226 so that the falling edge slew rate is enhanced which balances the noninverting slew rate response.

Large Signal,  $A_V = +25$

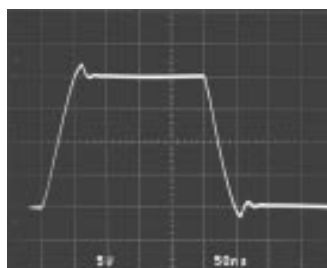

Large Signal,  $A_V = -25$

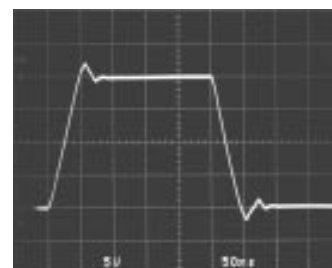

LT1226 A103

### Input Considerations

Resistors in series with the inputs are recommended for the LT1226 in applications where the differential input voltage exceeds  $\pm 6V$  continuously or on a transient basis. An example would be in noninverting configurations with high input slew rates or when driving heavy capacitive loads. The use of balanced source resistance at each input is recommended for applications where DC accuracy must be maximized.

### Capacitive Loading

The LT1226 is stable with all capacitive loads. This is accomplished by sensing the load induced output pole and adding compensation at the amplifier gain node. As the capacitive load increases, both the bandwidth and phase margin decrease so there will be peaking in the

## APPLICATIONS INFORMATION

frequency domain and in the transient response. The photo of the small signal response with 1000pF load shows 55% peaking. The large signal response with a 10,000pF load shows the output slew rate being limited by the short circuit current.

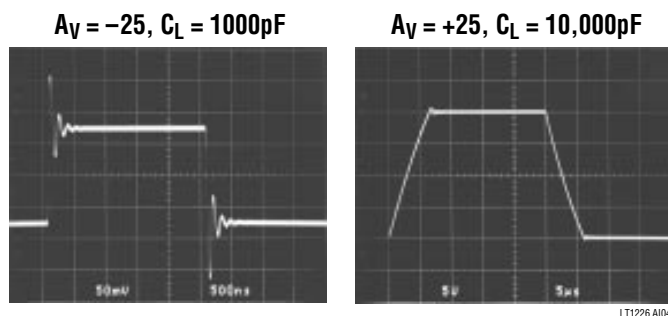

The LT1226 can drive coaxial cable directly, but for best pulse fidelity the cable should be doubly terminated with a resistor in series with the output.

### Compensation

The LT1226 has a typical gain bandwidth product of 1GHz which allows it to have wide bandwidth in high gain

configurations (i.e., in a gain of 1000 it will have a bandwidth of about 1MHz). The amplifier is stable in a noise gain of 25 so the ratio of the output signal to the inverting input must be 1/25 or less. Straightforward gain configurations of +25 or -24 are stable, but there are a few configurations that allow the amplifier to be stable for lower signal gains (the noise gain, however, remains 25 or more). One example is the inverting amplifier shown in the typical applications sections below. The input signal has a gain of  $-R_F/R_{IN}$  to the output, but it is easily seen that this configuration is equivalent to a gain of -24 as far as the amplifier is concerned. Lag compensation can also be used to give a low frequency gain less than 25 with a high frequency gain of 25 or greater. The example below has a DC gain of 6, but an AC gain of +31. The break frequency of the RC combination across the amplifier inputs should be at least a factor of 10 less than the gain bandwidth of the amplifier divided by the high frequency gain (in this case 1/10 of 1GHz/31 or 3MHz).

## TYPICAL APPLICATIONS

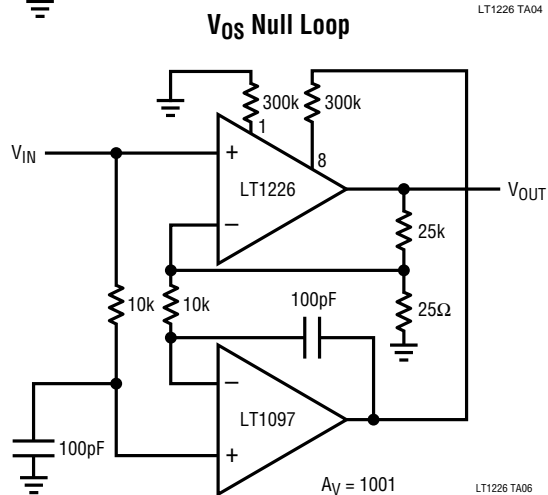
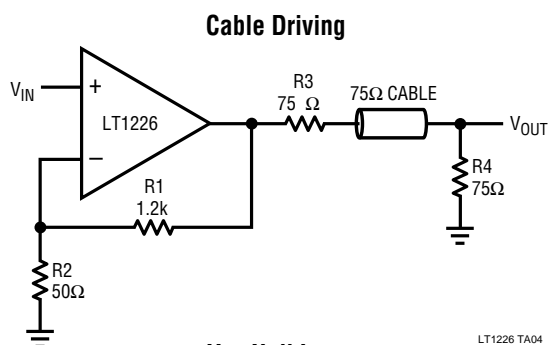
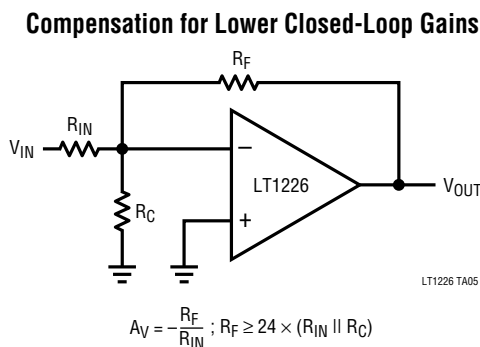
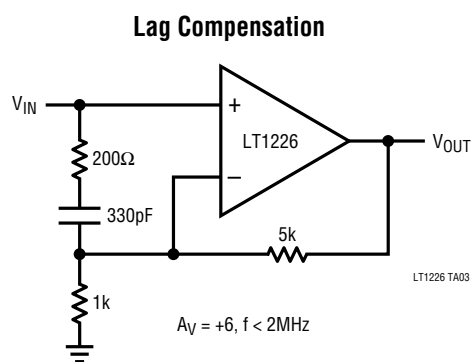

**SIMPLIFIED SCHEMATIC**

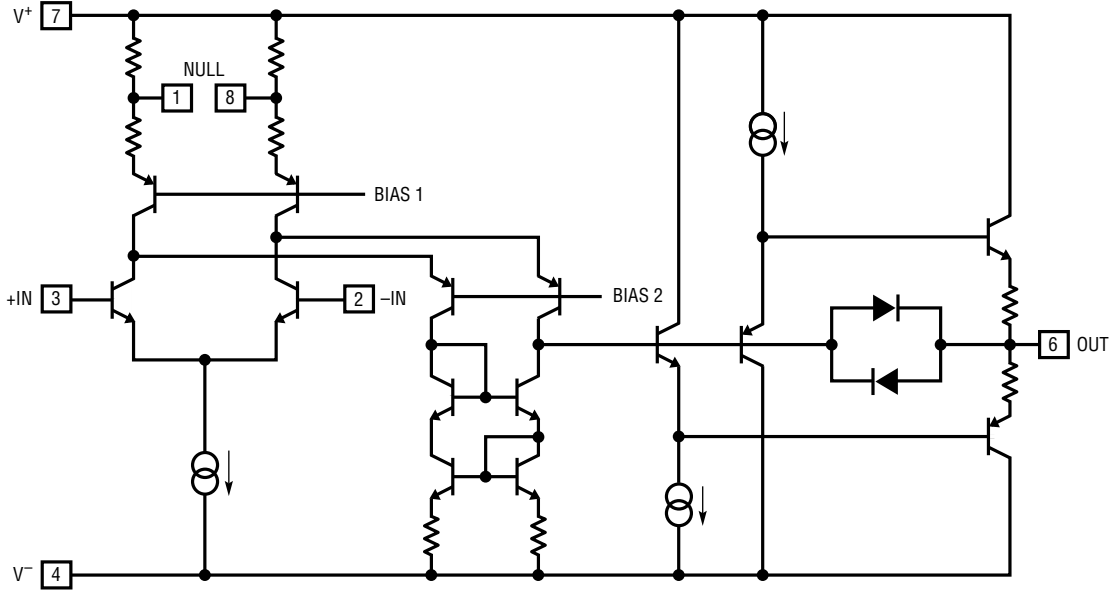

LT1226 SS

**PACKAGE DESCRIPTION** Dimensions in inches (millimeters) unless otherwise noted.

**N8 Package  
8-Lead Plastic DIP**

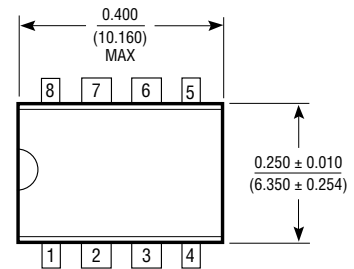
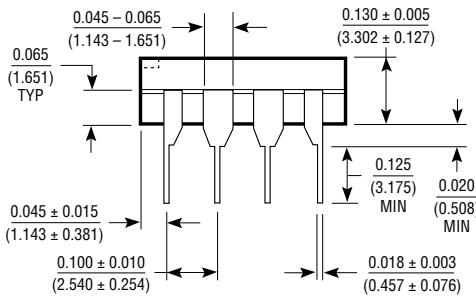
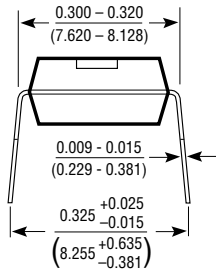

T <sub>J</sub> MAX	θ <sub>JA</sub>
150°C	130°C/W

N8 1291

**S8 Package  
8-Lead Plastic SOIC**

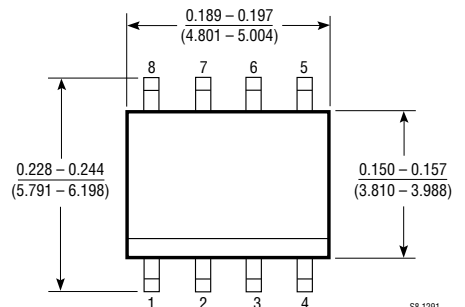
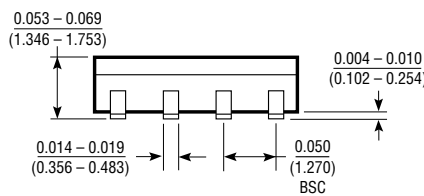
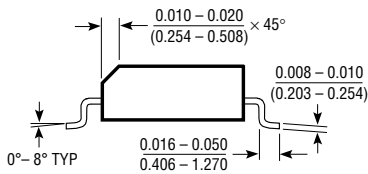

T <sub>J</sub> MAX	θ <sub>JA</sub>
150°C	220°C/W

S8 1291



# Mouser Electronics

Authorized Distributor

Click to View Pricing, Inventory, Delivery & Lifecycle Information:

[Analog Devices Inc.:](#)

[LT1226CN8#PBF](#) [LT1226CS8#TRPBF](#) [LT1226CS8](#) [LT1226CN8](#) [LT1226CS8#PBF](#) [LT1226CS8#TR](#)