



Micro Commercial Components



Micro Commercial Components
 20736 Marilla Street Chatsworth
 CA 91311
 Phone: (818) 701-4933
 Fax: (818) 701-4939

UF5400GP THRU UF5408GP

3 Amp Ultra Fast Glass Passivated Recovery Rectifier 50 to 1000 Volts

Features

- Lead Free Finish/RoHS Compliant(Note 1) ("P" Suffix designates RoHS Compliant. See ordering information)
- Epoxy meets UL 94 V-0 flammability rating
- Moisture Sensitivity Level 1
- Glass Passivated Junction
- Low Forward Voltage Drop and High Surge Capability
- Ultra Fast Switching Speed For High Efficiency
- Halogen free available upon request by adding suffix "-HF"

Maximum Ratings

- Operating Temperature: -55°C to +150°C
- Storage Temperature: -55°C to +150°C
- Typical Thermal Resistance 20°C/W

MCC Catalog Number	Device Marking	Maximum Recurrent Peak Reverse Voltage	Maximum RMS Voltage	Maximum DC Blocking Voltage
UF5400GP	---	50V	35V	50V
UF5401GP	---	100V	70V	100V
UF5402GP	---	200V	140V	200V
UF5404GP	---	400V	280V	400V
UF5406GP	---	600V	420V	600V
UF5407GP	---	800V	560V	800V
UF5408GP	---	1000V	700V	1000V

Electrical Characteristics @ 25°C Unless Otherwise Specified

Average Forward Current	$I_{F(AV)}$	3 A	$T_A = 55^\circ\text{C}$
Peak Forward Surge Current	I_{FSM}	100A	8.3ms, half sine
Maximum Instantaneous Forward Voltage UF5400GP-5402GP UF5404GP UF5406GP-5408GP	V_F	1.0V 1.3V 1.7V	$I_{FM} = 3.0A;$ $T_A = 25^\circ\text{C}$
Maximum DC Reverse Current At Rated DC Blocking Voltage	I_R	10 μ A 50 μ A	$T_A = 25^\circ\text{C}$ $T_A = 100^\circ\text{C}$
Maximum Reverse Recovery Time UF5400GP-5404GP UF5406GP-5408GP	T_{rr}	50ns 75ns	$I_F=0.5A, I_R=1.0A,$ $I_{rr}=0.25A$
Typical Junction Capacitance UF5400GP-5404GP UF5406GP-5408GP	C_J	75pF 50pF	Measured at 1.0MHz, $V_R=4.0V$

Notes:1.High Temperature Solder Exemption Applied, see EU Directive Annex 7.

DO-201AD

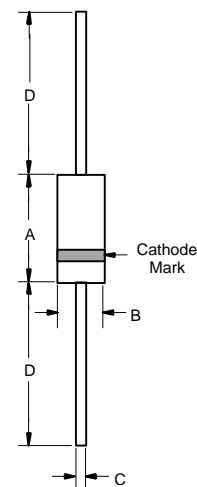

DIM	DIMENSIONS				NOTE
	INCHES		MM		
A	.287	.374	7.30	9.50	
B	.189	.208	4.80	5.30	
C	.048	.052	1.20	1.30	
D	1.000	---	25.40	---	

UF5400GP thru UF5408GP

Figure 1
Typical Forward Characteristics

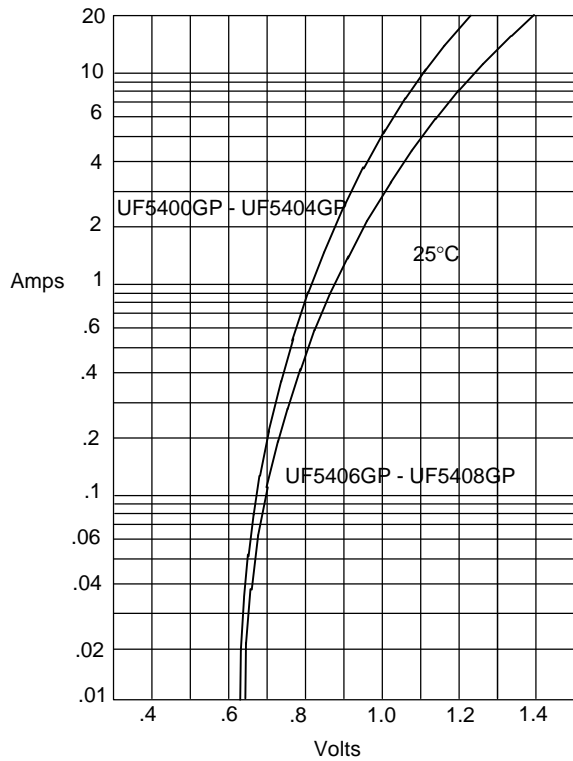

Instantaneous Forward Current - Amperes versus
Instantaneous Forward Voltage - Volts

Figure 2
Forward Derating Curve

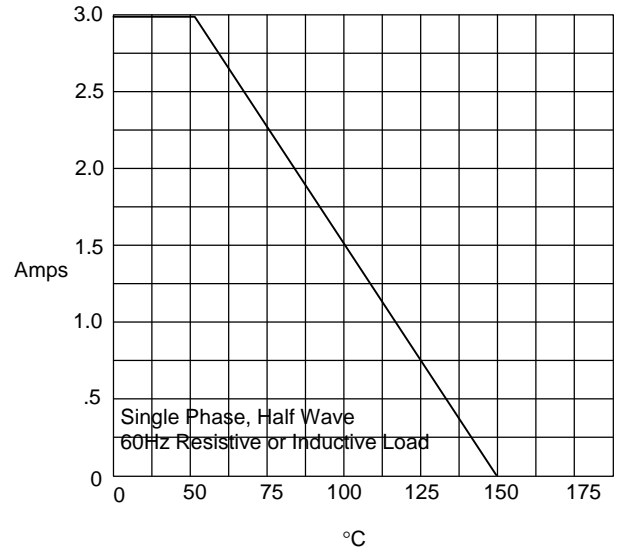

Average Forward Rectified Current - Amperes versus
Ambient Temperature - °C

Figure 3
Junction Capacitance

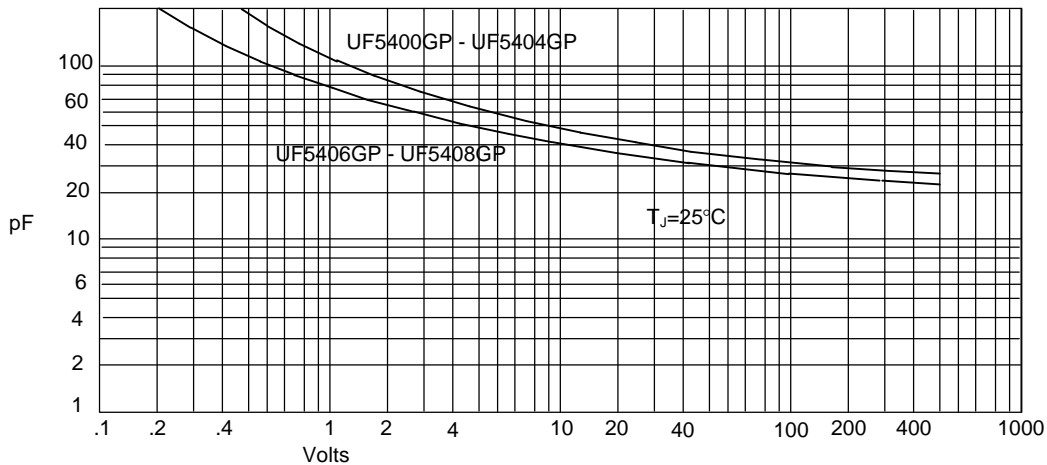

Junction Capacitance - pF versus
Reverse Voltage - Volts

UF5400GP thru UF5408GP

Figure 4
Typical Reverse Characteristics

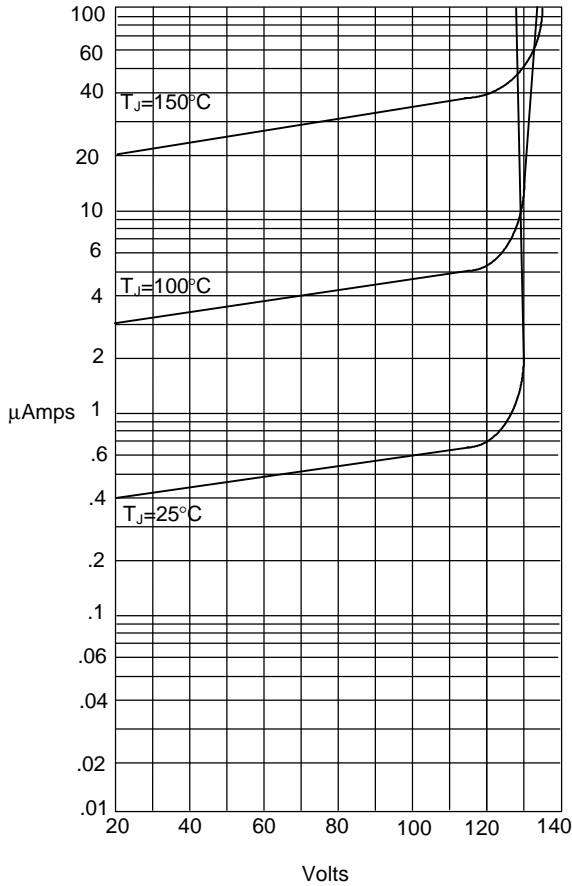

Instantaneous Reverse Leakage Current - MicroAmperes versus
Percent Of Rated Peak Reverse Voltage - Volts

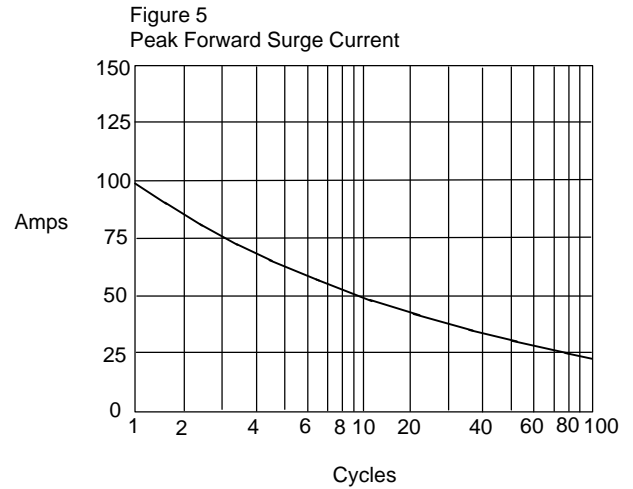

Peak Forward Surge Current - Amperes versus
Number Of Cycles At 60Hz - Cycles

Figure 6
Reverse Recovery Time Characteristic And Test Circuit Diagram

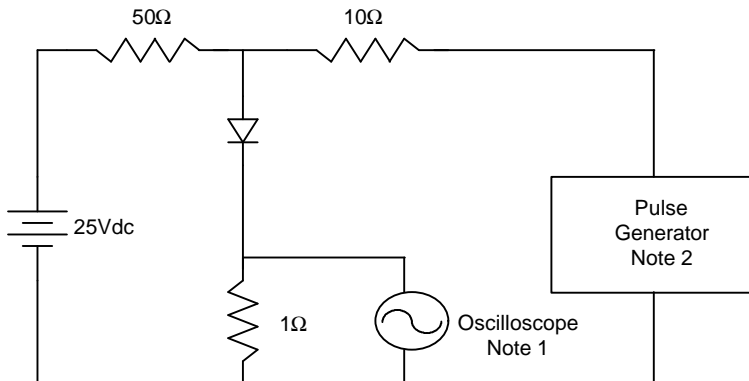

Notes:

1. Rise Time = 7ns max.
Input impedance = 1 megohm, 22pF
2. Rise Time = 10ns max.
Source impedance = 50 ohms
3. Resistors are non-inductive

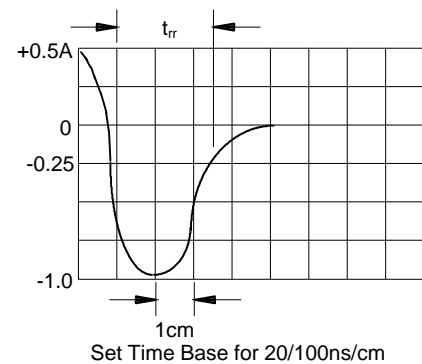



Micro Commercial Components

Ordering Information :

Device	Packing
Part Number-TP	Tape&Reel: 1.2Kpcs/Reel
Part Number-AP	Ammo Packing: 1.2Kpcs/Ammo Box
Part Number-BP	Bulk: 12Kpcs/Carton

Note : Adding "-HF" suffix for halogen free, eg. Part Number-TP-HF

IMPORTANT NOTICE

Micro Commercial Components Corp. reserves the right to make changes without further notice to any product herein to make corrections, modifications, enhancements, improvements, or other changes. **Micro Commercial Components Corp.** does not assume any liability arising out of the application or use of any product described herein; neither does it convey any license under its patent rights, nor the rights of others. The user of products in such applications shall assume all risks of such use and will agree to hold **Micro Commercial Components Corp.** and all the companies whose products are represented on our website, harmless against all damages.

LIFE SUPPORT

MCC's products are not authorized for use as critical components in life support devices or systems without the express written approval of Micro Commercial Components Corporation.

CUSTOMER AWARENESS

Counterfeiting of semiconductor parts is a growing problem in the industry. Micro Commercial Components (MCC) is taking strong measures to protect ourselves and our customers from the proliferation of counterfeit parts. MCC strongly encourages customers to purchase MCC parts either directly from MCC or from Authorized MCC Distributors who are listed by country on our web page cited below. Products customers buy either from MCC directly or from Authorized MCC Distributors are genuine parts, have full traceability, meet MCC's quality standards for handling and storage. **MCC will not provide any warranty coverage or other assistance for parts bought from Unauthorized Sources.** MCC is committed to combat this global problem and encourage our customers to do their part in stopping this practice by buying direct or from authorized distributors.