

General Description

The DS8500 evaluation kit (EV kit) provides a convenient platform to evaluate the DS8500 HART® modem. It allows quick evaluation through a demonstration mode and in-depth evaluation using HART Communication Foundation (a part of FieldComm Group) tools.

EV Kit Contents

- DS8500 EV Kit Board
- Micro-USB Cable

Benefits and Features

- The EV Kit Provides Fast and Simple Evaluation by Providing a Total HART Communications Chain on Board
- Example HART Master and Field Device Circuits Demonstrate Usage in the Two Most Common HART Connection Configurations
- HART Registered Modem IC
- On-Board Isolated 4mA–20mA Communications Loop
- MAXQ622 USB Microcontroller with Demo Firmware
- External Connections Allow for Advanced Evaluation of the DS8500 in Other Configurations

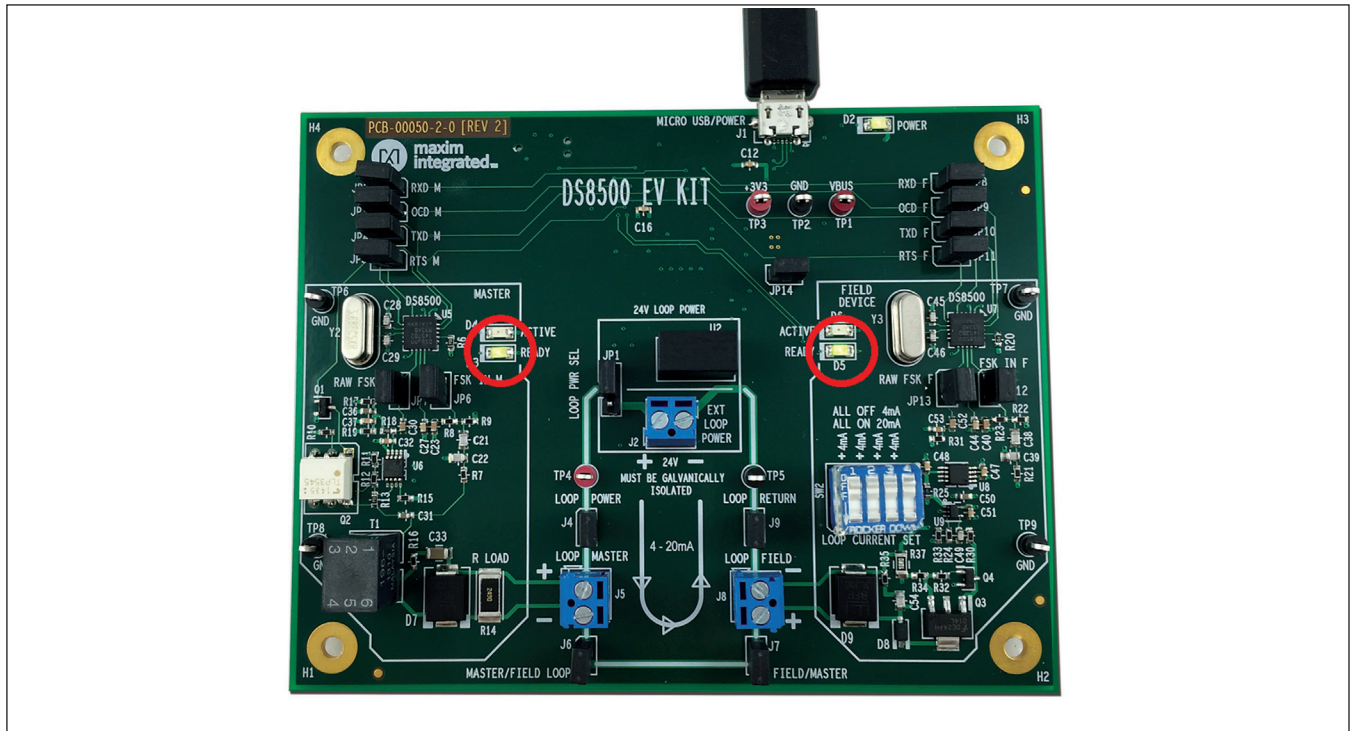

Figure 1. USB Connection and READY LEDs

HART and HART Registered are registered trademarks of the HART Communication Foundation Corp.

Quick Start

The DS8500 EV kit comes with demonstration firmware already loaded.

- 1) Download and install the **DS8500 EVKIT Software GUI** at www.maximintegrated.com/evkitsoftware.
- 2) Use the included Micro-USB cable to connect and power the EV kit as shown in [Figure 1](#).
- 3) Wait until the READY LEDs (circled in [Figure 1](#)) light after the board has finished USB enumeration. This can take several seconds.
- 4) Start the DS8500 EVKIT GUI from the **Start** menu by selecting **Maxim Integrated | DS8500 | DS8500 Evaluation Kit**. [Figure 2](#) shows the demo GUI. It automatically finds the USB-connected EV kit.
- 5) Simply type messages from the **Master** or **Field Device** window and press the **Send** button to transmit and receive modulated data over the on-board 4–20mA current loop.
- 6) Observe the ACTIVE LEDs lighting while transmitting and receiving.

Detailed Description of Hardware

Users must also use the DS8500 IC data sheet in conjunction with this EV kit data sheet.

Power Supply

The EV kit uses USB power for all on-board devices.

On-Board 4–20mA Current Loop

The current loop is isolated from board ground and power allowing communications between **Master** and **Field Device**, both implemented by serial ports on the MAXQ622. This common connection necessitates use of a fully isolated 4–20mA loop, which is very sensitive to ground loops, thus direct probing of the on-board loop is **strongly discouraged** and could **damage** the EV kit. Note that this is a nontypical configuration specifically designed for demonstration purposes. In typical installations, **Master** and **Field Device** are separately located, with the **Field Device** floating, often powered by loop current.

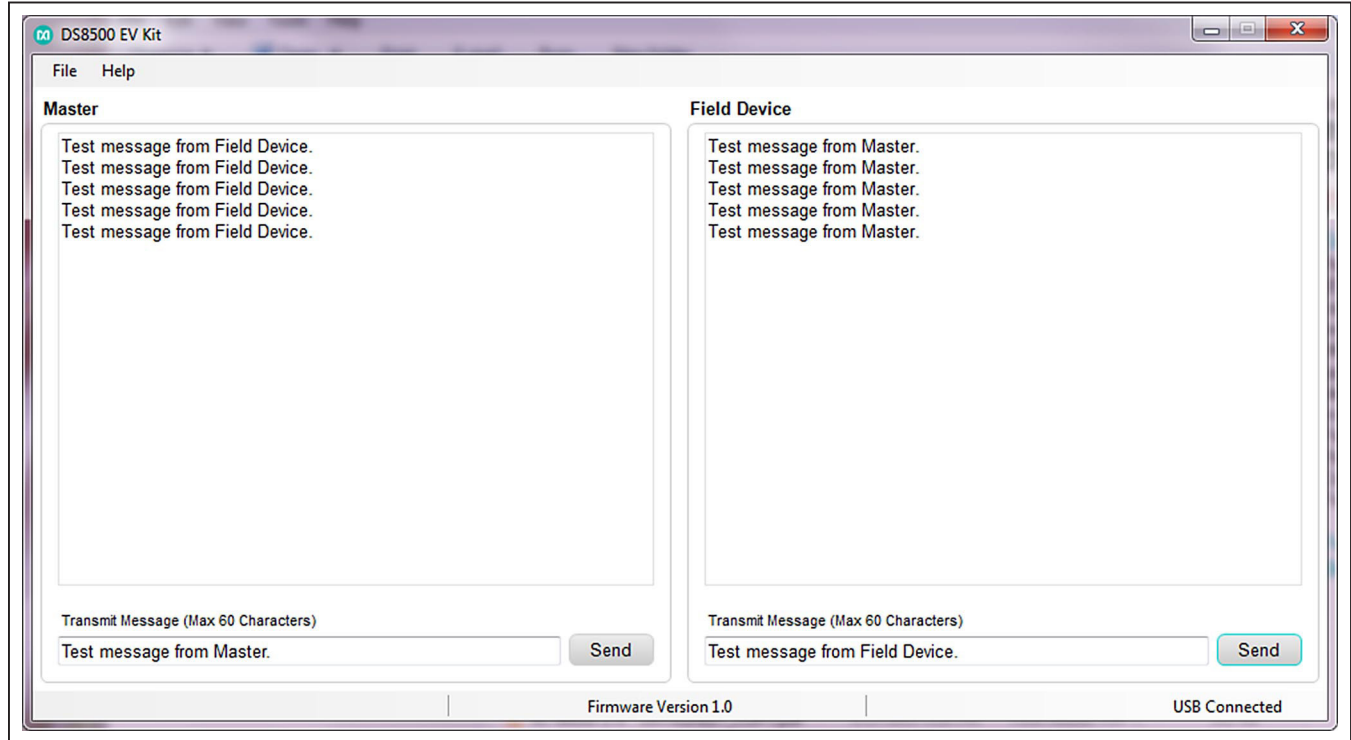

Figure 2. DS8500 EV Kit Demo GUI

Interface Ports

Jumpers JP2–JP5 provide direct access to the serial control signals for the **Master** side of the HART loop. Jumpers JP8–JP11 provide direct access to the serial control signals for the **Field Device** side of the HART loop. These allow connection to an embedded microcontroller or computer running a HART stack via 3.3V TTL serial UART. See [Table 1](#) and the [Advanced Evaluation](#) section for more details.

Each DS8500 exposes FSK_OUT and FSK_IN signals via jumper for probing purposes ([Table 2](#)).

Jumper Functions

The DS8500 EV kit is equipped with 17 jumpers for disconnecting pins and modifying the EV kit features. [Table 3](#) details the jumpers not previously covered.

External Connectors

The EV kit has three terminal blocks for easy loop/wire connections. See [Table 4](#).

Advanced Evaluation

The DS8500 EV kit can communicate directly with actual HART devices or software-emulated devices. The on-board MAXQ622 is only for demonstration purposes

Table 1. Master and Field Device Control Signals

PORT PIN	PIN NAME	PIN TYPE	DESCRIPTION
JP2	HRXD_M	Output	Digital serial data output from MASTER DS8500 (DOUT)
JP3	HOCD_M	Output	Carrier detect output from MASTER DS8500
JP4	HTXD_M	Input	Digital serial data input to MASTER DS8500 (DIN)
JP5	HRTS_M	Input	Active-low request to send signal for MASTER DS8500
JP8	HRXD_F	Output	Digital serial data output from FIELD DEVICE DS8500 (DOUT)
JP9	HOCD_F	Output	Carrier detect output from FIELD DEVICE DS8500
JP10	HTXD_F	Input	Digital serial data input to FIELD DEVICE DS8500 (DIN)
JP11	HRTS_F	Input	Active-low request to send signal for FIELD DEVICE DS8500

Note: Serial signals are 3.3V TTL.

Table 2. FSK Probe and Disconnect Jumpers

JUMPER	NAME	TYPE	DESCRIPTION
JP6	FSK_IN_M	Input	MASTER side incoming FSK-modulated serial signal
JP7	RAW_FSK_M	Output	MASTER side outgoing FSK-modulated serial signal
JP12	FSK_IN_F	Input	FIELD DEVICE side incoming FSK-modulated serial signal
JP13	RAW_FSK_F	Output	FIELD DEVICE side outgoing FSK-modulated serial signal

Table 3. Jumper Settings

JUMPER	SETTING	EFFECT
JP1 (1-2)	Closed*	Powers the 4–20mA loop from on-board power
	Open	Disconnects 4–20mA loop from on-board power
JP1 (2-3)	Closed	Connect external loop power from connector J2
	Open*	Disconnects external loop power from connector J2
J4	Closed*	Connects loop power to master device
	Open	Isolates loop power from master device
J5	Closed*	Connect master to field device via loop
	Open	Isolates master from field device via loop
J7	Closed*	Connects field device to master via loop
	Open	Isolates field device from master via loop
J9	Closed*	Connects field device to loop return
	Open	Isolates field device from loop return
JP14	Closed*	Connects VBUS power (5V) to loop 24V power supply
	Open	Disconnects power from loop supply for noise reduction

*Default position.

Table 4. External Connectors

CONNECTOR	PURPOSE
J2	Power the 4–20mA loop from an external galvanic isolated supply or battery
J5	Wire connection interface to MASTER
J8	Wire connection interface to FIELD DEVICE

(USB interface) and does not implement a HART software stack. The serial UART data and control pins are exposed via jumpers as detailed in [Table 1](#). They allow a hardware serial port on a PC or laptop to transmit and receive modulated signals. Note that these serial pins expect TTL level signals (3.3V), not RS-232 level, so a serial level shifter board is typically required for communications.

The following examples detail two evaluation setups. Other configurations are possible, including emulating both simultaneously, or connection to an actual Field Device. However, these are beyond the scope of this document. **Note:** The following configurations require hardware and software tools available from the FieldComm Group or other sources and are not included with the DS8500 EV kit.

Emulated HART Field Device

To use the DS8500 EV kit as a Field Device interface, follow the setup detailed in [Figure 3](#), using the on-board 24V loop power supply and load resistor. Simply connect a personal computer running HART master software, (e.g., HCF_KIT_180) and a HART serial modem (e.g., HCF_TOOL-35, available with the Physical Layer Test Kit HCF_KIT-116). The reference modem's loop connections attach across the Field Device as shown. Verify that the jumpers (J7 and J9) remain in place, even with the loop connections attached.

Another personal computer simulates the behavior of an actual field device by running the XMTR MV tool (HCF_TOOL-039). Remove jumpers JP8–JP11 and connect the serial signals to the computer via a RS-232 level shifter.

To test, launch the XMTR MV program, then start the Master software and observe communications.

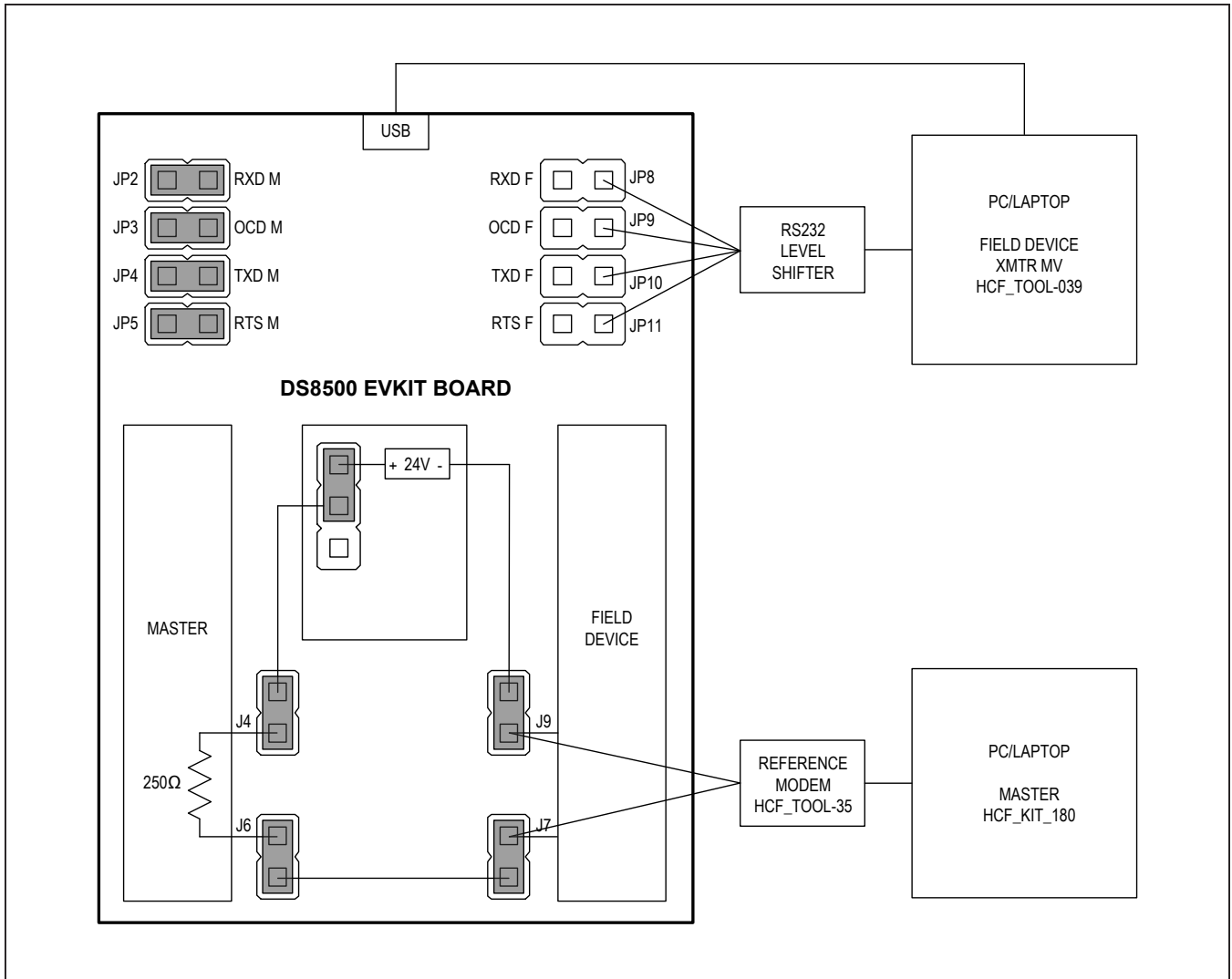

Figure 3. Setup for Emulated Field Device Evaluation

Emulated HART Primary/Secondary Master

To use the DS8500 EV kit as a Master or Secondary Master, follow the setup detailed in [Figure 4](#). This example does not require loop power so completely remove jumpers J4 and J6 to isolate the Master side of the EV kit from the on-board loop. Remove jumpers JP2–JP5 and connect the serial signals to the computer via a RS-232 level shifter. This computer runs HART master software (e.g., HCF_KIT_180).

Another personal computer simulates the behavior of the Field Device by running the XMTR MV tool (HCF_TOOL-039) and using a HART serial modem (e.g., HCF_TOOL-35, available with the Physical Layer Test Kit HCF_KIT-116). The reference modem’s loop connections attach across the load resistor as shown in [Figure 4](#).

To test, launch the XMTR MV program, then start the Master software and observe communications.

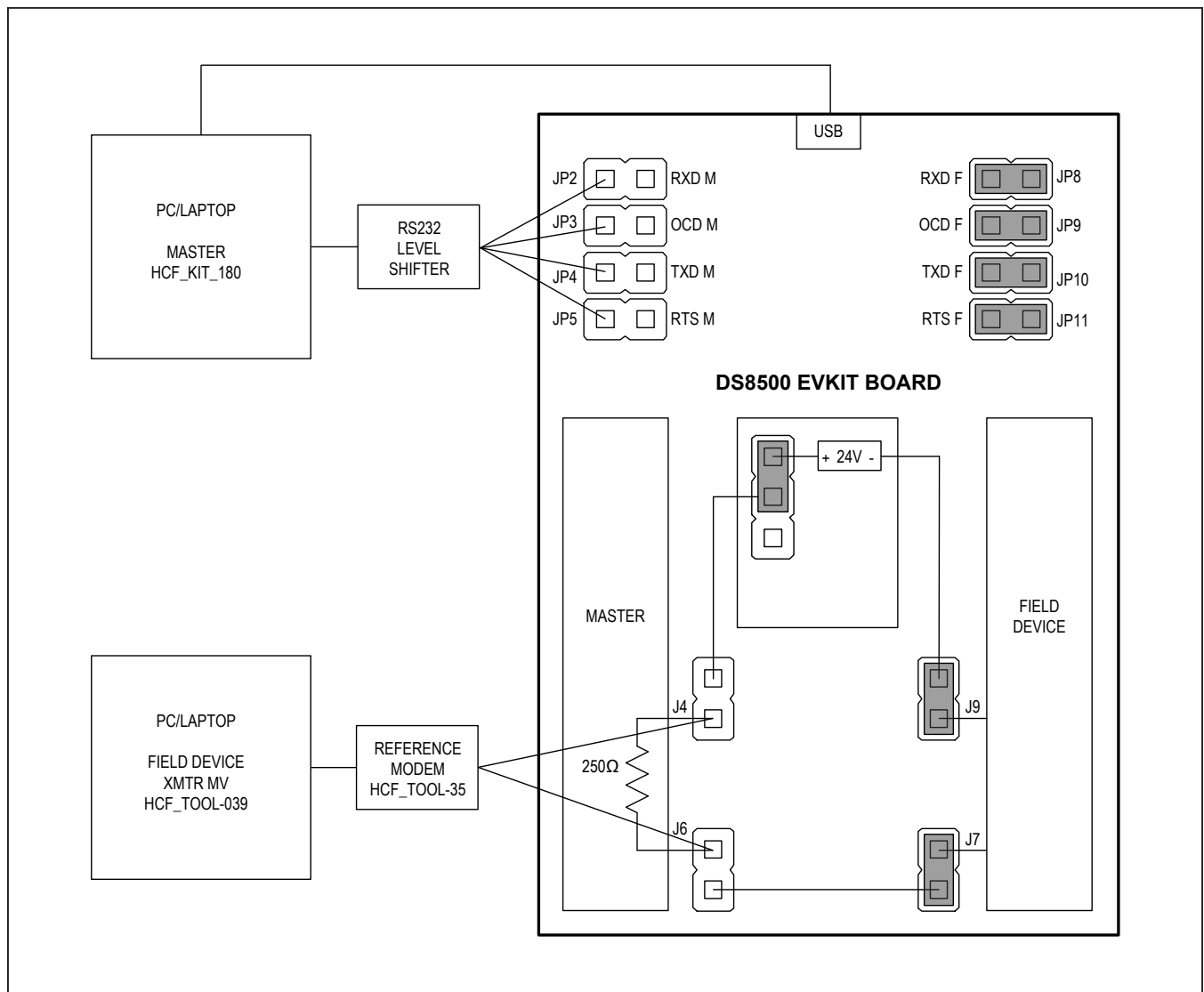

Figure 4. Setup for Emulated Master Evaluation

Component List, Schematics, and PCB Layout

See the following links for component list, PCB layout, and schematics:

- [DS8500-KIT BOM](#)
- [DS8500-KIT schematics](#)
- [DS8500-KIT PCB layout](#)

Ordering Information

PART	TYPE
DS8500-KIT#	EV Kit

#Denotes RoHS compliant.

Revision History

REVISION NUMBER	REVISION DATE	DESCRIPTION	PAGES CHANGED
0	11/10	Initial release	—
1	9/15	Rewrote data sheet to include GUI and jumper descriptions and settings	1–8

For pricing, delivery, and ordering information, please contact Maxim Direct at 1-888-629-4642, or visit Maxim Integrated's website at www.maximintegrated.com.

Maxim Integrated cannot assume responsibility for use of any circuitry other than circuitry entirely embodied in a Maxim Integrated product. No circuit patent licenses are implied. Maxim Integrated reserves the right to change the circuitry and specifications without notice at any time.

Bill of Materials (BOM) (Rev 1; 6/15)									
Item Number	Quantity	Part Reference	Value	BOM_Description	Manufacturer_PN	Vendor_PN	Vendor	PKG_Size	
1	4	BMP1 BMP2 BMP3 BMP4	Bumper	BUMPER CYLIN 0.375" DIA BLK	SJ61A4	SJ5750-0-ND	Digi-Key	0.375" Dia x 0.311" H	
2	2	C1 C2	10uF	CAP CER 10uF 10V 10% X7R 0805	GRM21BR71A106KE51L	490-3905-1-ND	Digi-Key	0805	
3	8	C3 C13 C15 C17 C19 C35 C36 C50	1uF	CAP CER 1uF 10V 20% X5R 0603	GRM188R61A105MA61D	490-1544-1-ND	Digi-Key	0603	
4	21	C5 C7 C11 C12 C14 C16 C18 C20 C24 C25 C26 C27 C34 C37 C41 C42 C43 C44 C47 C48 C51	100nF	CAP CER 0.1uF 16V 10% X7R 0603	C0603C104K4RACTU	399-1096-1-ND	Digi-Key	0603	
5	2	C9 C10	18pF	CAP CER 18PF 50V 5% NP0 0402	GRM1555C1H180JA01D	490-5858-1-ND	Digi-Key	0402	
6	3	C21 C38 C54	2.2nF	CAP CER 2200PF 50V 5% NP0 0805	GRM2165C1H222JA01D	490-1628-1-ND	Digi-Key	0805	
7	2	C22 C39	10nF	CAP CER 10000PF 50V 5% NP0 0805	GRM2195C1H103JA01D	490-1642-1-ND	Digi-Key	0805	
8	2	C23 C40	1uF	CAP CER 1uF 16V 10% X7R 0603	GCM188R71C105KA64D	490-5241-1-ND	Digi-Key	0603	
9	4	C28 C29 C45 C46	15pF	CAP CER 15PF 50V 5% NP0 0603	GRM1885C1H150JA01D	490-1407-1-ND	Digi-Key	0603	
10	4	C30 C32 C52 C53	33nF	CAP CER 0.033UF 10V 10% X7R 0603	C0603C333K8RACTU	399-9070-1-ND	Digi-Key	0603	
11	1	C31	2.2uF	CAP CER 2.2uF 10V 10% X5R 0603	C0603C225K8PACTU	399-4911-1-ND	Digi-Key	0603	
12	1	C33	2.2uF	CAP CER 2.2UF 50V 10% X7R 1206	GRM31CR71H225KA88L	490-3367-1-ND	Digi-Key	1206	
13	1	C49	1nF	CAP CER 1nF 50V 5% NP0 0603	GRM1885C1H102JA01D	490-1451-1-ND	Digi-Key	0603	
14	1	C55	22uF	CAP ALUM 22UF 50V 20% SMD	RPS1H220MCN1GS	493-6648-1-ND	Digi-Key	Alum 8mm Dia (Case E)	
15	1	C56	1uF	CAP CER 1UF 50V 10% X7R 1206	C3216X7R1H105K160AB	445-1423-1-ND	Digi-Key	1206	
16	1	C57	100nF	CAP CER 0.1UF 50V 10% X7R 0603	C0603C104K5RACTU	399-5089-1-ND	Digi-Key	0603	
17	1	C59	47uF	CAP ALUM 47UF 6.3V 20% SMD 5mm Dia	PCS0J470MCL1GS	493-3966-1-ND	Digi-Key	Alum 5mm Dia SMD	
18	1	D1	SMF5.0A-TP	TVS 200W 5V UNIDIR SOD-123FL	SMF5.0A-TP	SMF5.0A-TPMSCT-ND	Digi-Key	SOD-123	
19	3	D2 D3 D5	GRN	LED 565NM WTR CLR GREEN 1206 SMD	SML-LX1206GC-TR	67-1357-1-ND	Digi-Key	1206	
20	2	D4 D6	YEL	LED ALINGAP YELLOW CLR 1206 SMD	SML-LX1206SYC-TR	67-1699-1-ND	Digi-Key	1206	
21	2	D7 D9	SMCJ36CA	TVS DIODE 36VWM 58.1VC SMC	SMCJ36CA	SMCJ36CALFCT-ND	Digi-Key	SMC (DO-214AB)	
22	1	D8	1N5819HW-7-F	DIODE SCHOTTKY 40V 1A SOD123	1N5819HW-7-F	1N5819HW-FDICT-ND	Digi-Key	SOD-123	
23	1	F1	350mA	FUSE PTC RESET 350MA SMD 0603	MF-FSMF035X-2	MF-FSMF035X-2CT-ND	Digi-Key	0603	
24	1	H1	DNI	DNI MTG 125DRL 300PAD				MTG 125DRL 300PAD	
25	1	H2	DNI	DNI MTG 125DRL 300PAD				MTG 125DRL 300PAD	
26	1	H3	DNI	DNI MTG 125DRL 300PAD				MTG 125DRL 300PAD	
27	1	H4	DNI	DNI MTG 125DRL 300PAD				MTG 125DRL 300PAD	
28	1	J1	MICRO USB AB RCPT RA	CONN RCPT MICRO USB AB R/A SMD	47589-0001	WM17143CT-ND	Digi-Key	47589-0001	
29	3	J2 J5 J8	2P 3.5mm	TERM BLOCK 3.5MM VERT 2POS PCB	OSTTE020161	ED2635-ND	Digi-Key	2P (3.5MM LS)	
30	1	J3	DNI	MAXQ_POGO_PIN CBL PLUG-OF-NAILS 10-PIN	TC2050-IDC-NL	TC2050-IDC-NL-ND	Digi-Key	TC2050-IDC-NL	
31	17	J4 J6 J7 J9 JP2 JP3 JP4 JP5 JP6 JP7 JP8 JP9 JP10 JP11 JP12 JP13 JP14	JUMPER	CONN HEADER .100 SINGL STR 2POS (2x1)	PEC02SAAN	S1012E-02-ND	Digi-Key	2x1 (0.1" LS)	
32	1	JP1	3P JUMPER	CONN HEADER .100 SINGL STR 3POS	PEC03SAAN	S1012E-03-ND	Digi-Key	3X1 (0.1" LS)	
33	2	L1 L5	HZ1206C202R-10	FERRITE CHIP SIGNAL 2000 OHM SMD	HZ1206C202R-10	240-2413-1-ND	Digi-Key	1206	
34	2	L2 L3	100uH	IND 100UH 0.16A MINI DRUM SMD	82104C	811-2479-1-ND	Digi-Key	8200 Series	
35	1	L4	6.8uH	FIXED IND 6.8UH 640MA 270 MOHM	82682C	811-2472-1-ND	Digi-Key	8200 Series	
36	1	PCB1	PCB						
37	1	Q1	FDV304P	MOSFET P-CH 25V 460MA SOT-23	FDV304P	FDV304PCT-ND	Digi-Key	SOT-23 3P	
38	1	Q2	TLP3545(F)	PHOTOCOUPLER PHOTORELAY 6-DIP	TLP3545(F)	TLP3545(F)-ND	Digi-Key	6P DIP	
39	1	Q3	NDT014L	MOSFET N-CH 60V 2.8A SOT-223	NDT014L	NDT014LCT-ND	Digi-Key	SOT-223	
40	1	Q4	MMBT3904	TRANSISTOR GP NPN AMP SOT-23	MMBT3904	MMBT3904FSCT-ND	Digi-Key	SOT-23-3	

41	1	R1	681	RES 681 OHM 1/10W 1% 0603 SMD	ERJ-3EKF6810V	P681HCT-ND	Digi-Key	0603
42	4	R2 R3 R4 R5	150	RES 150 OHM 1/10W 1% 0603 SMD	ERJ-3EKF1500V	P150HCT-ND	Digi-Key	0603
43	4	R6 R13 R18 R20	100K	RES 100K OHM 1/10W 1% 0603 SMD	ERJ-3EKF1003V	P100KHCT-ND	Digi-Key	0603
44	2	R7 R21	1.58K	RES 1.58K OHM 1/10W 1% 0603 SMD	ERJ-3EKF1581V	P1.58KHCT-ND	Digi-Key	0603
45	2	R8 R23	221K	RES 221K OHM 1/10W 1% 0603 SMD	ERJ-3EKF2213V	P221KHCT-ND	Digi-Key	0603
46	2	R9 R22	301K	RES 301K OHM 1/10W 1% 0603 SMD	ERJ-3EKF3013V	P301KHCT-ND	Digi-Key	0603
47	1	R10	49.9	RES 49.9 OHM 1/10W 1% 0603 SMD	ERJ-3EKF49R9V	P49.9HCT-ND	Digi-Key	0603
48	2	R11 R15	10K	RES 10K OHM 1/10W 1% 0603 SMD	ERJ-3EKF1002V	P10.0KHCT-ND	Digi-Key	0603
49	1	R12	12.4K	RES 12.4K OHM 1/10W 1% 0603 SMD	ERJ-3EKF1242V	P12.4KHCT-ND	Digi-Key	0603
50	1	R14	249	RES 249 OHM 1W 1% 2512 SMD	MCR100JZHF2490	RHM249BBCT-ND	Digi-Key	2512
51	1	R16	10	RES 10 OHM 1/10W 1% 0603 SMD	ERJ-3EKF10R0V	P10.0HCT-ND	Digi-Key	0603
52	4	R17 R19 R24 R32	1K	RES 1K OHM 1/10W 1% 0603 SMD	ERJ-3EKF1001V	P1.00KHCT-ND	Digi-Key	0603
53	5	R25 R26 R27 R28 R29	1.24M	RES 1.24M OHM 1/10W 1% 0603 SMD	CRCW06031M24FKEA	541-1.24MHCT-ND	Digi-Key	0603
54	2	R30 R33	300	RES 300 OHM 1/10W 1% 0603 SMD	ERJ-3EKF3000V	P300HCT-ND	Digi-Key	0603
55	1	R31	511K	RES 511K OHM 1/10W 1% 0603 SMD	ERJ-3EKF5113V	P511KHCT-ND	Digi-Key	0603
56	1	R34	24.3	RES 24.3 OHM 1/10W 1% 0603 SMD	ERJ-3EKF24R3V	P24.3HCT-ND	Digi-Key	0603
57	1	R35	100	RES 100 OHM 1/10W 1% 0603 SMD	ERJ-3EKF1000V	P100HCT-ND	Digi-Key	0603
58	1	R36	20K	RES 20K OHM 1/10W .1% 0603 SMD	ERA-3AEB203V	P20KDBCT-ND	Digi-Key	0603
59	1	R37	10	RES SMD 10 OHM 0.1% 1/8W 1206	CRT1206-BY-10R0ELF	CRT1206-BY-10R0ELFCT-ND	Digi-Key	1206
60	1	R38	10K	RES SMD 10K OHM 1% 1/4W 1206	ERJ-8ENF1002V	P10.0KFCT-ND	Digi-Key	1206
61	17	SJ1 SJ2 SJ3 SJ4 SJ5 SJ6 SJ7 SJ8 SJ9 SJ10 SJ11 SJ12 SJ13 SJ14 SJ15 SJ16 SJ17	SHUNT	CONN JUMPER SHORTING TIN	STC02SYAN	S9000-ND	Digi-Key	BLK Shunt
62	1	SW2	DIP SW 4POS	SWITCH DIP 4POS SEALED GOLD	3-5435640-5	450-1404-ND	Digi-Key	8P DIP (0.1" LS)
63	1	T1	MET-26	TRANSFORMER 1KCT:1KCT 3.0MADC	MET-26	838-MET-26	Mouser	MET-26
64	3	TP1 TP3 TP4	RED	TEST POINT PC COMPACT .063"D RED	5005	5005K-ND	Digi-Key	Compact
65	6	TP2 TP5 TP6 TP7 TP8 TP9	BLK	TEST POINT PC COMPACT .063"D BLK	5006	5006K-ND	Digi-Key	Compact
66	1	U1	MAX1806EUA33+	IC REG LDO 3.3V/ADJ 0.5A 8UMAX	MAX1806EUA33+	MAX1806EUA33+-ND	Digi-Key	8P Power-Umax
67	1	U2	NME0524SC	CONV DC/DC 1W 5VIN 24V SIP SGL	NME0524SC	811-1481-5-ND	Digi-Key	4-SIP Module
68	1	U3	MAXQ622G-0000+	IC MCU 16BIT 128KB IR MOD 64LQFP	MAXQ622G-0000+	MAXQ622G-0000+-ND	Digi-Key	64P LQFP
69	1	U4	MAX3207EAUT+T	ESD PROT DIFF SOT23-6	MAX3207EAUT+T	MAX3207EAUT+TCT-ND	Digi-Key	6P SOT-23
70	2	U5 U7	DS8500-JND+	IC MODEM HART SGL 3.6V 20-TQFN	DS8500-JND+	DS8500-JND+-ND	Digi-Key	20P 5x5 TQFN
71	1	U6	MAX4166EUA+	IC OPAMP GP 5MHZ RRO 8UMAX	MAX4166EUA+	MAX4166EUA+-ND	Digi-Key	8P UMAX
72	1	U8	MAX6133A25+	IC VREF SERIES 2.5V 8UMAX	MAX6133A25+	MAX6133A25+-ND	Digi-Key	8P UMAX
73	1	U9	MAX9620AXK+T	IC OPAMP CHOPPER 1.5MHZ SC70-5	MAX9620AXK+T	MAX9620AXK+TCT-ND	Digi-Key	SC70 5P
74	1	Y1	12MHz	CRYSTAL 12MHZ 18PF SMD	ABM3-12.000MHZ-D2Y-T	535-10634-1-ND	Digi-Key	5x3.2 ABM3
75	2	Y2 Y3	3.6864MHz	CRYSTAL 3.6864MHZ 18PF THRU	ECS-36-18-4X	X1042-ND	Digi-Key	HC49/US

EVKIT POWER IN (USB VBUS)

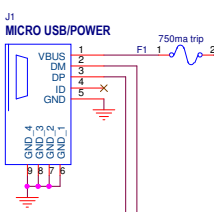

PRIMARY VOLTAGE REGULATOR

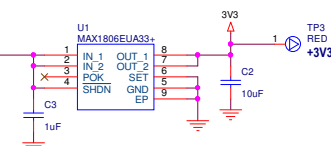

Add jumper to U2 power inlet. Simplify output filter.

GALVANICALLY ISOLATED DC-DC CONVERTER

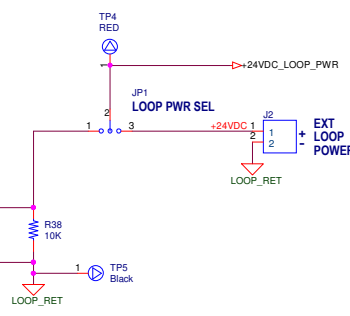
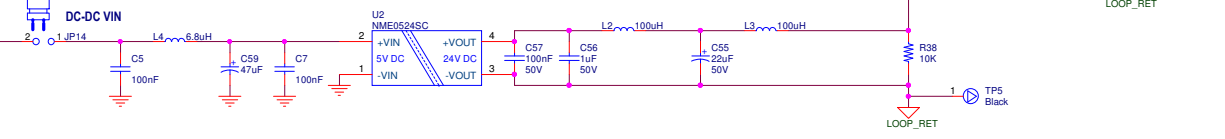

ESD PROTECTION

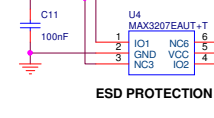

MAXQ622 PROGRAMMING JTAG PORT

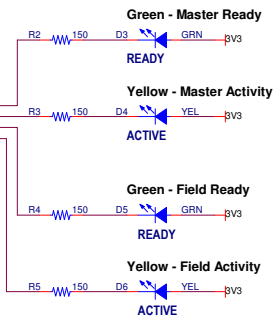
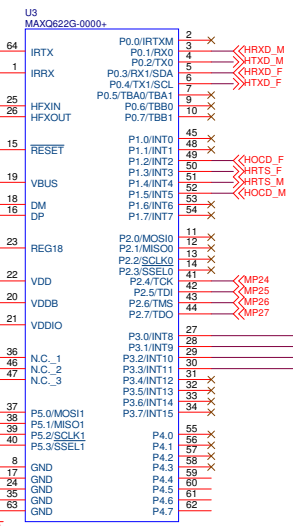
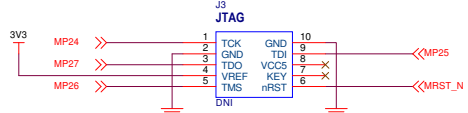

MOUNTING HOLES & BUMPER

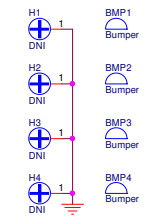

UART INTERFACE

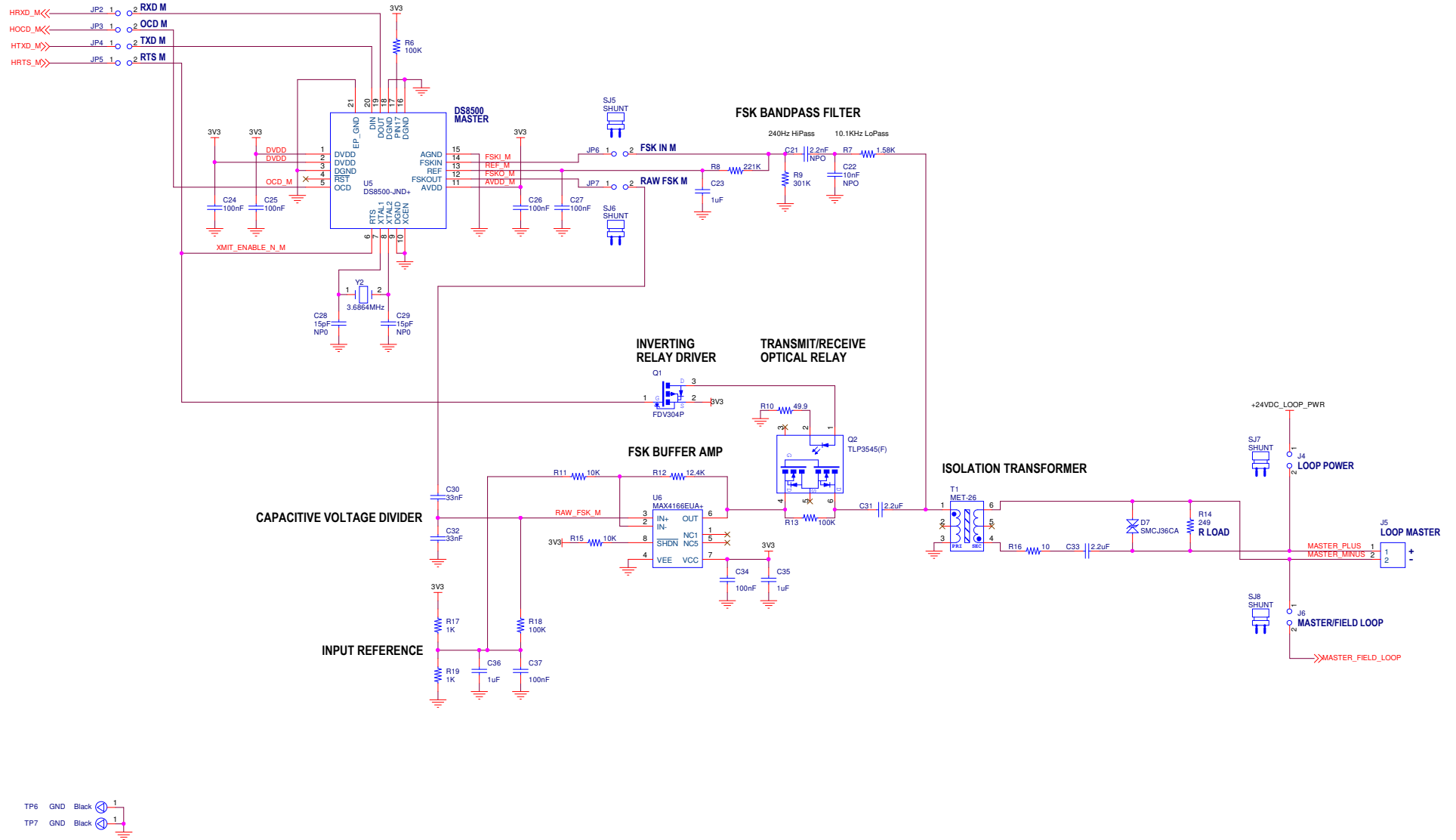
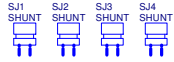

UART INTERFACE

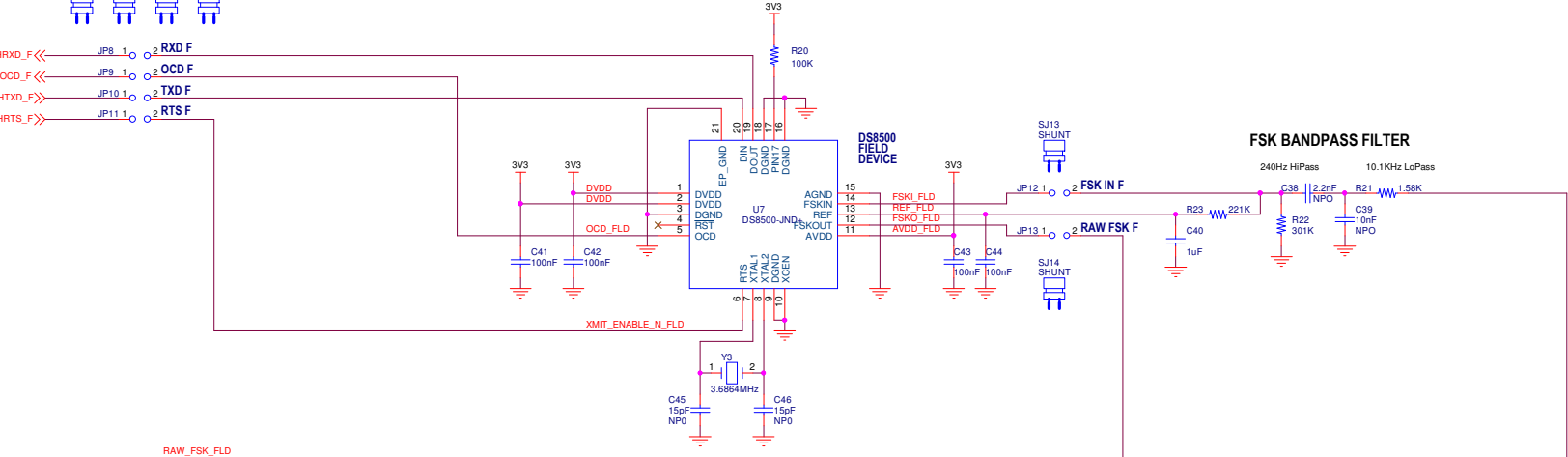
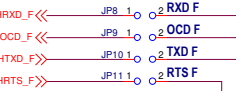

FSK BANDPASS FILTER

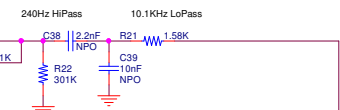

RAW_FSK_FLD

VOLTAGE REFERENCE

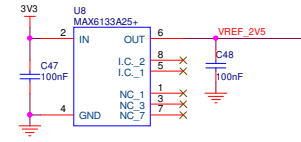

LOOP CURRENT SELECT

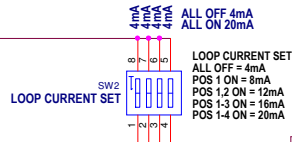

ERROR AMPLIFIER

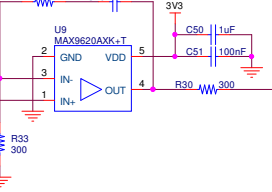

CURRENT REGULATOR

PASS TRANSISTOR

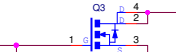

REVERSE POLARITY PROTECTION

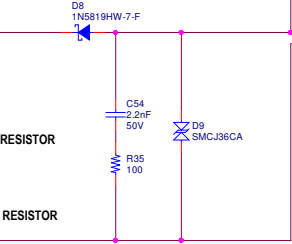

CAPACITIVE VOLTAGE DIVIDER

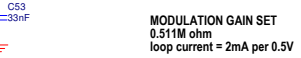

MODULATION GAIN SET
0.511M ohm
loop current = 2mA per 0.5V

LOOP FEEDBACK GAIN SET
Rsense 10 ohms
Rfeedback 20K ohms
Loop current = 1mA per 0.5uA summing node current

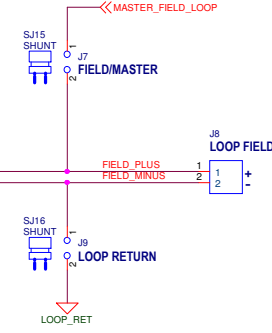

	SILKSCREEN TOP
	SOLDER MASK TOP
LAYER 1 TOP	1 OZ. FINISHED COPPER
LAYER 2 GND PLANE	PREPREG 0.0039"
LAYER 3 PWR PLANE	0.5 OZ. COPPER
LAYER 4 BOTTOM	CORE 0.047"
	0.5 OZ. COPPER
	PREPREG 0.0039"
	1 OZ. FINISHED COPPER
	SOLDER MASK BOTTOM
	SILKSCREEN BOTTOM

- NOTES:
1. ALL MEASUREMENTS ARE IN INCHES.
 2. THE PWB SHALL BE FABRICATED TO IPC-6012, CLASS 2 AND WORKMANSHIP SHALL CONFORM TO IPC-A-600, CLASS 2, CURRENT REV. DIMENSIONING AND TOLERANCE OF PRINTED WIRING BOARD SHALL BE PER IPC-D-300 (CURRENT REV).
 3. BOARD MATERIAL TO BE MULTI-FUNCTIONAL FR-4 EXPOXY GLASS LAMINATE, AND SHALL MEET OR EXCEED MIL-P-13949. COLOR - NATURAL.
 4. BOARD MATERIAL AND CONSTRUCTION TO BE U.L. APPROVED AND MARKED ON THE FINISHED BOARD.
 5. MINIMUM COPPER WALL THICKNESS OF PLATED-THRU HOLES TO BE .001 INCHES
 6. OVERALL BOARD THICKNESS TO BE .062 +/- 10% AND APPLIES AFTER ALL LAMINATION AND PLATING PROCESSES. MEASURED FROM COPPER TO COPPER.
 7. MAX WARP AND TWIST TO BE .01 INCHES PER INCH.
 8. BOARD MUST BE ELECTRICALLY TESTED USING THE SUPPLIED IPC-D -356 NETLIST.
 9. PLATE ALL EXPOSED AREAS WITH ELECTROLESS IMMERSION GOLD, NICKEL 100 MICROINCHES THK. GOLD 2-6 MICROINCHES THK MIN.

- PROCESS NOTES:
1. APPLY LPI SOLDERMASK, BOTH SIDES, OVER BARE COPPER (SMOBC) COLOR: GREEN
SOLDERMASK SHALL CONFORM TO IPC-SM-840, CLASS H, AND CURRENT REVISION. VIAS SHALL BE TENTED OR CLEARED BY SOLDERMASK PER ARTWORK. FABRICATION VENDOR IS ALLOWED TO ADJUST SOLDERMASK FEATURES AS NEEDED AS LONG AS SOLDERMASK DAMS ARE MAINTAINED BETWEEN ALL SMD PADS.
 2. SILKSCREEN BOTH SIDES USING LPI SILKSCREEN, COLOR: WHITE.
PLACE ANY VENDOR SERIAL NUMBER ASSOCIATED TO PANEL ON BOTTM SIDE OF BOARD.

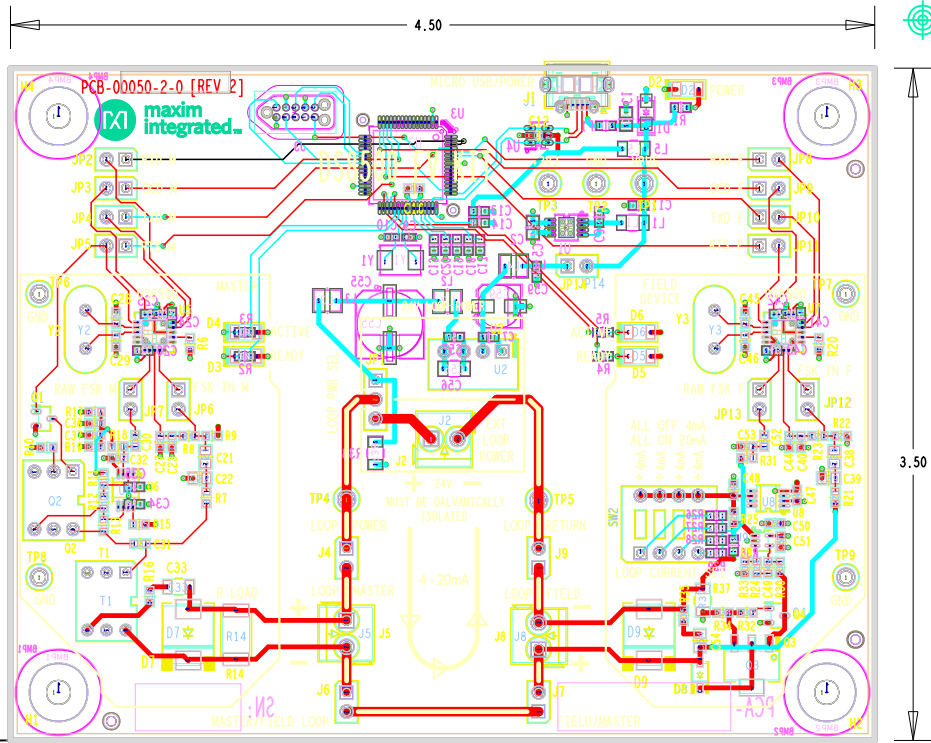

BOARD NAME: DS8500 EV KIT		
P/N: PCB-00050-2-0	DATE: 02-19-2015	
LAYER: DRILL TEMPERATURE SOLDER MASK (TOP)		

	SILKSCREEN TOP
	SOLDER MASK TOP
LAYER 1 TOP	1 OZ. FINISHED COPPER
LAYER 2 GND PLANE	PREPREG 0.0039"
LAYER 3 PWR PLANE	0.5 OZ. COPPER
LAYER 4 BOTTOM	CORE 0.047"
	0.5 OZ. COPPER
	PREPREG 0.0039"
	1 OZ. FINISHED COPPER
	SOLDER MASK BOTTOM
	SILKSCREEN BOTTOM

- NOTES:
1. ALL MEASUREMENTS ARE IN INCHES.
 2. THE PWB SHALL BE FABRICATED TO IPC-6012, CLASS 2 AND WORKMANSHIP SHALL CONFORM TO IPC-A-600, CLASS 2, CURRENT REV. DIMENSIONING AND TOLERANCE OF PRINTED WIRING BOARD SHALL BE PER IPC-D-300 (CURRENT REV).
 3. BOARD MATERIAL TO BE MULTI-FUNCTIONAL FR-4 EPOXY GLASS LAMINATE, AND SHALL MEET OR EXCEED MIL-P-13949. COLOR - NATURAL.
 4. BOARD MATERIAL AND CONSTRUCTION TO BE U.L. APPROVED AND MARKED ON THE FINISHED BOARD.
 5. MINIMUM COPPER WALL THICKNESS OF PLATED-THRU HOLES TO BE .001 INCHES
 6. OVERALL BOARD THICKNESS TO BE .062 +/- 10% AND APPLIES AFTER ALL LAMINATION AND PLATING PROCESSES. MEASURED FROM COPPER TO COPPER.
 7. MAX WARP AND TWIST TO BE .01 INCHES PER INCH.
 8. BOARD MUST BE ELECTRICALLY TESTED USING THE SUPPLIED IPC-D -356 NETLIST.
 9. PLATE ALL EXPOSED AREAS WITH ELECTROLESS IMMERSION GOLD, NICKEL 100 MICROINCHES THK. GOLD 2-6 MICROINCHES THK MIN.

- PROCESS NOTES:
1. APPLY LPI SOLDERMASK, BOTH SIDES, OVER BARE COPPER (SMOBC) COLOR: GREEN
SOLDERMASK SHALL CONFORM TO IPC-SM-840, CLASS H, AND CURRENT REVISION. VIAS SHALL BE TENTED OR CLEARED BY SOLDERMASK PER ARTWORK. FABRICATION VENDOR IS ALLOWED TO ADJUST SOLDERMASK FEATURES AS NEEDED AS LONG AS SOLDERMASK DAMS ARE MAINTAINED BETWEEN ALL SMD PADS.
 2. SILKSCREEN BOTH SIDES USING LPI SILKSCREEN, COLOR: WHITE.
PLACE ANY VENDOR SERIAL NUMBER ASSOCIATED TO PANEL ON BOTTM SIDE OF BOARD.

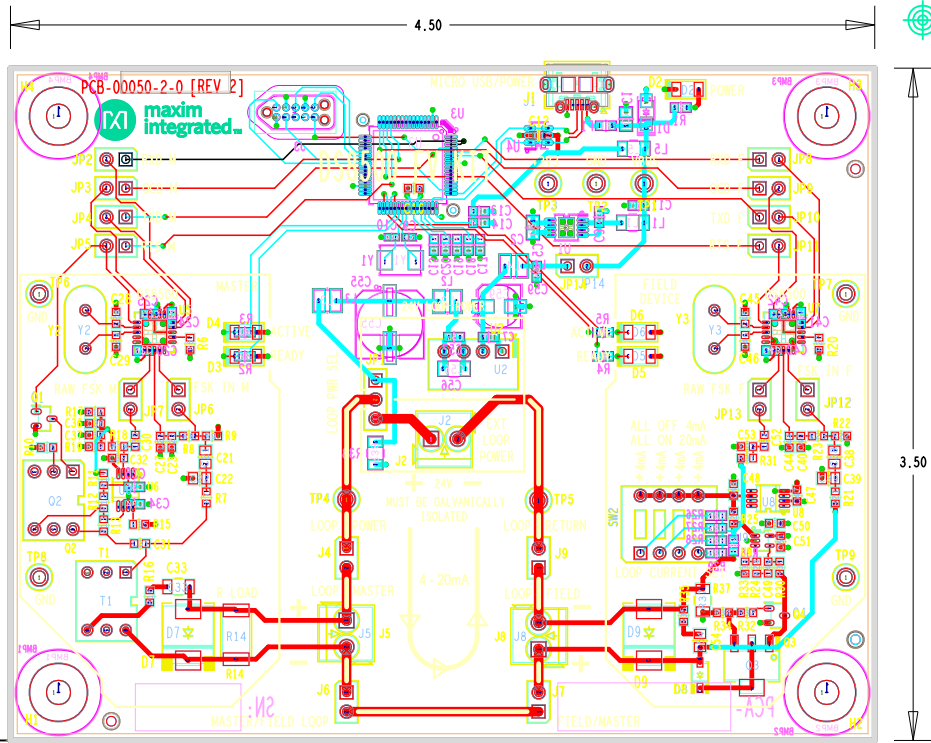

BOARD NAME: DS8500 EV KIT		
P/N: PCB-00050-2-0		DATE: 02-19-2015
LAYER: DR0008TEMPLETON00000000000000000000(TOP)		

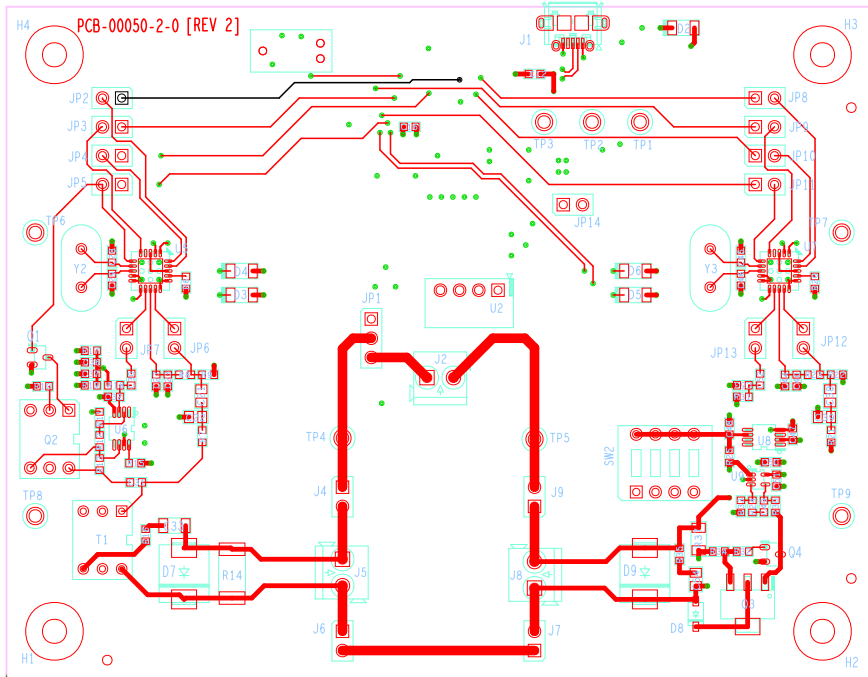

BOARD NAME: DS8500 EV KIT

P/N: PCB-00050-2-0

DATE: 02-19-2015

LAYER: LAYER11-DCOMPONENTPSIDE (TOP)

	SILKSCREEN TOP
	SOLDER MASK TOP
LAYER 1 TOP	1 OZ. FINISHED COPPER
LAYER 2 GND PLANE	PREPREG 0.0039"
LAYER 3 PWR PLANE	0.5 OZ. COPPER
LAYER 4 BOTTOM	CORE 0.047"
	0.5 OZ. COPPER
	PREPREG 0.0039"
	1 OZ. FINISHED COPPER
	SOLDER MASK BOTTOM
	SILKSCREEN BOTTOM

- NOTES:
1. ALL MEASUREMENTS ARE IN INCHES.
 2. THE PWB SHALL BE FABRICATED TO IPC-6012, CLASS 2 AND WORKMANSHIP SHALL CONFORM TO IPC-A-600, CLASS 2, CURRENT REV. DIMENSIONING AND TOLERANCE OF PRINTED WIRING BOARD SHALL BE PER IPC-D-300 (CURRENT REV).
 3. BOARD MATERIAL TO BE MULTI-FUNCTIONAL FR-4 EPOXY GLASS LIMINATE, AND SHALL MEET OR EXCEED MIL-P-13949. COLOR - NATURAL.
 4. BOARD MATERIAL AND CONSTRUCTION TO BE U.L. APPROVED AND MARKED ON THE FINISHED BOARD.
 5. MINIMUM COPPER WALL THICKNESS OF PLATED-THRU HOLES TO BE .001 INCHES
 6. OVERALL BOARD THICKNESS TO BE .062 +/- 10% AND APPLIES AFTER ALL LAMINATION AND PLATING PROCESSES. MEASURED FROM COPPER TO COPPER.
 7. MAX WARP AND TWIST TO BE .01 INCHES PER INCH.
 8. BOARD MUST BE ELECTRICALLY TESTED USING THE SUPPLIED IPC-D -356 NETLIST.
 9. PLATE ALL EXPOSED AREAS WITH ELECTROLESS IMMERSION GOLD, NICKEL 100 MICROINCHES THK. GOLD 2-6 MICROINCHES THK MIN.

- PROCESS NOTES:
1. APPLY LPI SOLDERMASK, BOTH SIDES, OVER BARE COPPER (SMOBC) COLOR: GREEN
SOLDERMASK SHALL CONFORM TO IPC-SM-840, CLASS H, AND CURRENT REVISION. VIAS SHALL BE TENTED OR CLEARED BY SOLDERMASK PER ARTWORK. FABRICATION VENDOR IS ALLOWED TO ADJUST SOLDERMASK FEATURES AS NEEDED AS LONG AS SOLDERMASK DAMS ARE MAINTAINED BETWEEN ALL SMD PADS.
 2. SILKSCREEN BOTH SIDES USING LPI SILKSCREEN, COLOR: WHITE.
PLACE ANY VENDOR SERIAL NUMBER ASSOCIATED TO PANEL ON BOTTM SIDE OF BOARD.

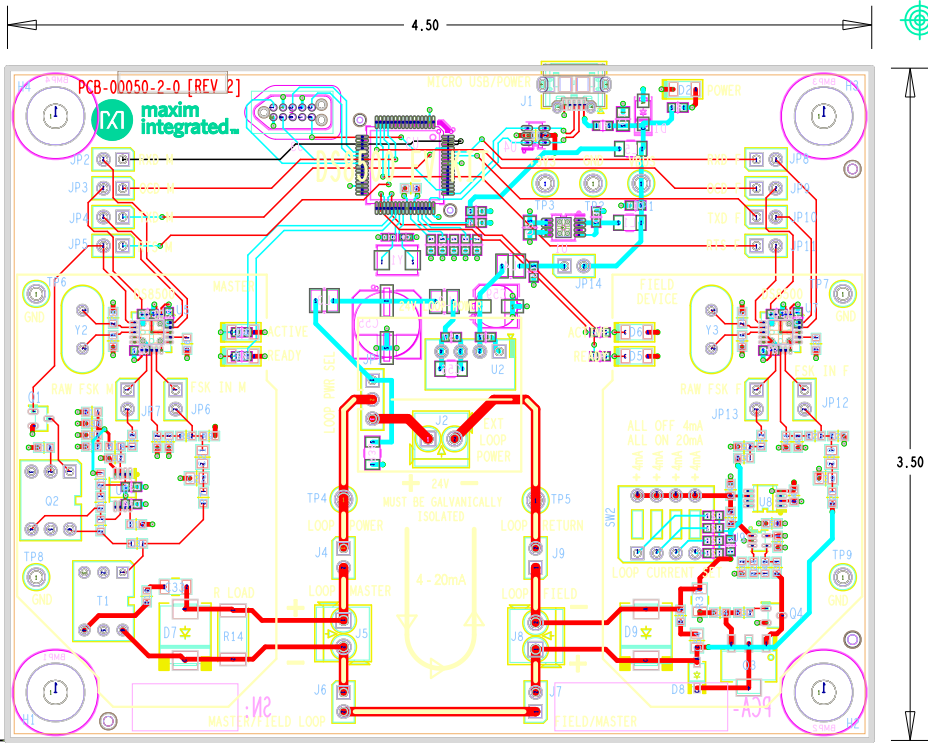

BOARD NAME: DS8500 EV KIT		
P/N: PCB-00050-2-0		DATE: 02-19-2015
LAYER: DRINKTEMPERATUREHONORUSSOBO(TOP)		

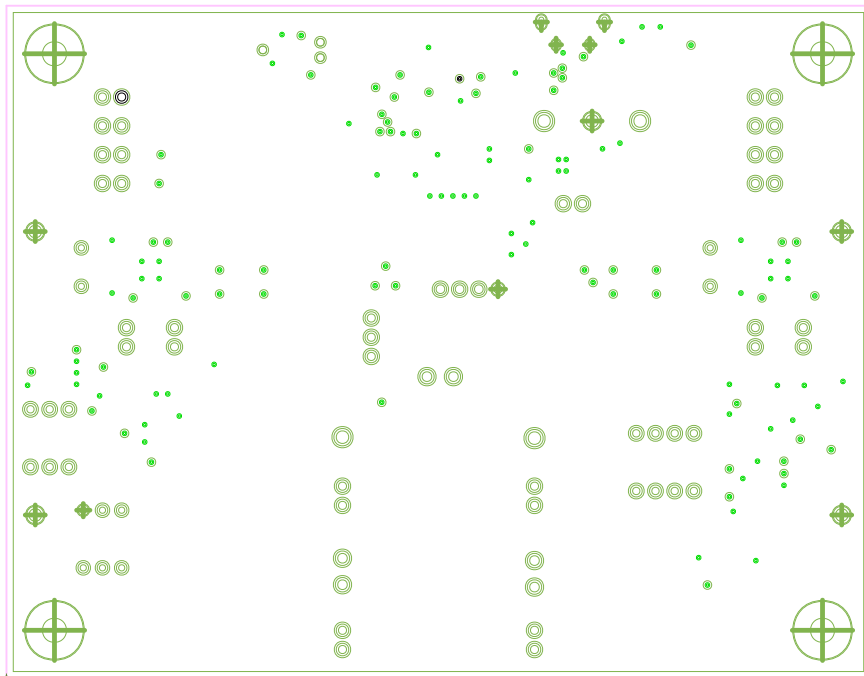

maxim
integrated

BOARD NAME: DS8500 EV KIT

P/N: PCB-00050-2-0

DATE: 02-19-2015

LAYER: LAYER 2 - GND PLANE

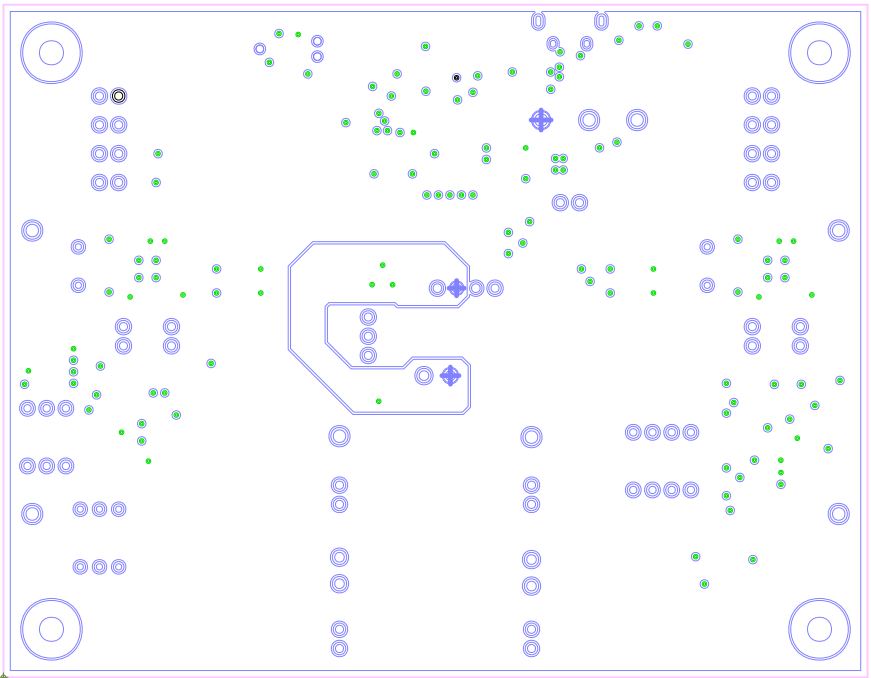

		
BOARD NAME: DS8500 EV KIT		
P/N: PCB-00050-2-0		DATE: 02-19-2015
LAYER: LAYER 3 - PWR PLANE		

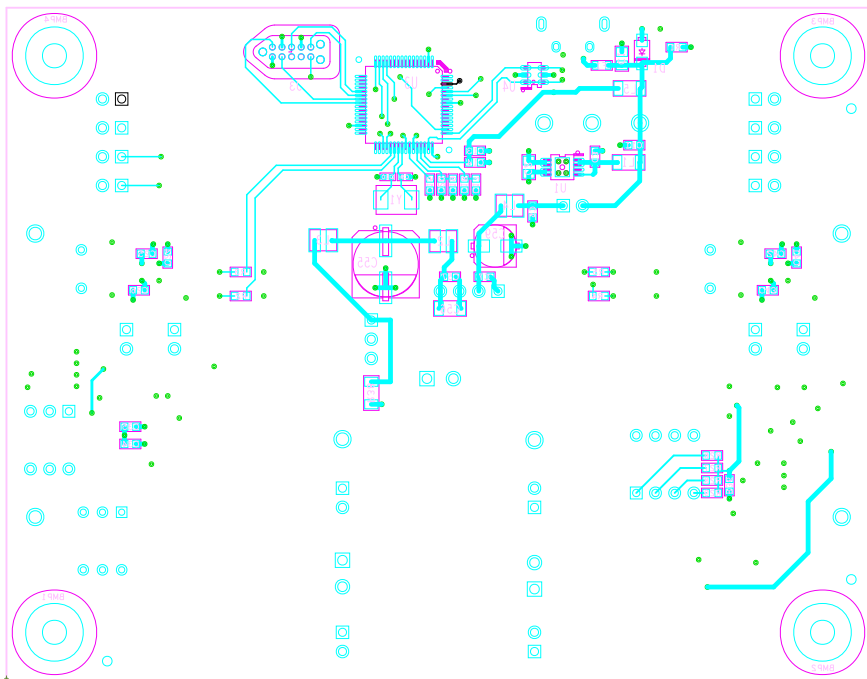

maxim
integrated

BOARD NAME: DS8500 EV KIT

P/N: PCB-00050-2-0

DATE: 02-19-2015

LAYER: ASSEMBLY-DRAWING BOTTOM(BOTTOM)



DS8500 EV KIT

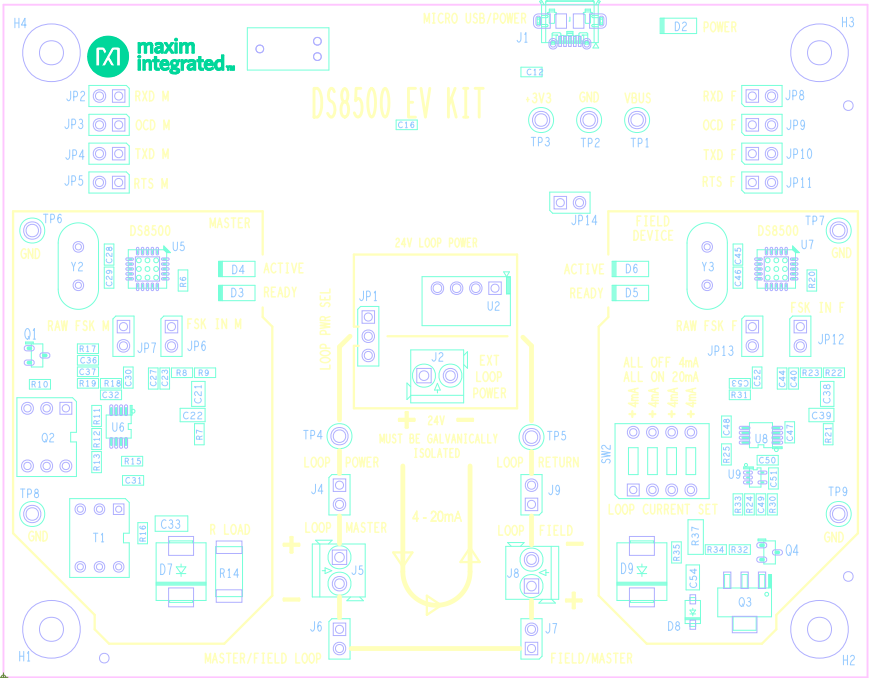

BOARD NAME: DS8500 EV KIT

P/N: PCB-00050-2-0

DATE: 02-19-2015

LAYER: ASSEMBLY DRAWING TOP

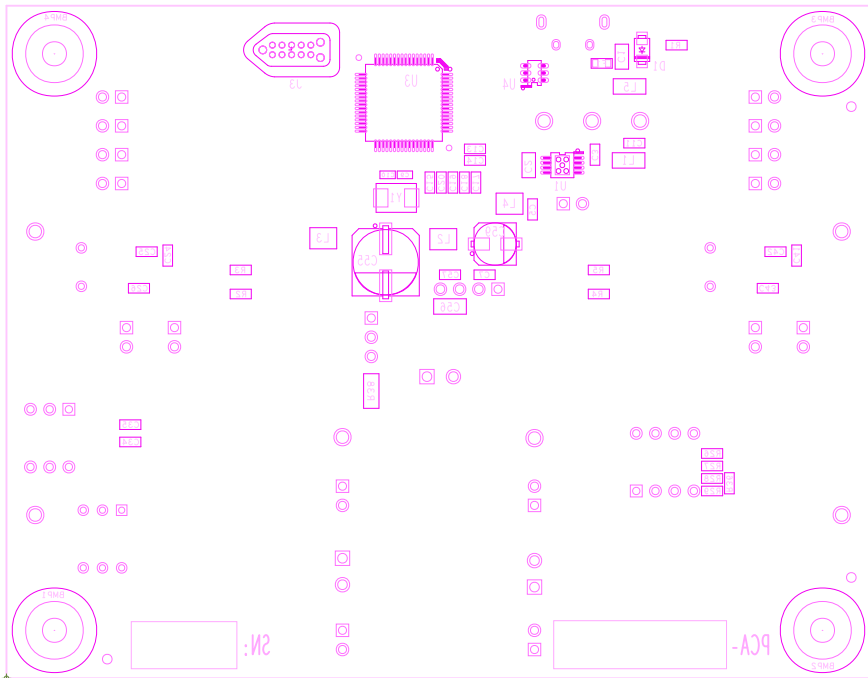

maxim
integrated

BOARD NAME: DS8500 EV KIT

P/N: PCB-00050-2-0

DATE: 02-19-2015

LAYER: ASSEMBLY DRAWING BOTTOM

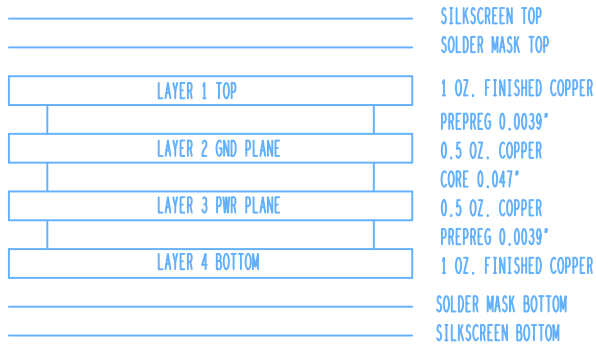

- NOTES:
1. ALL MEASUREMENTS ARE IN INCHES.
 2. THE PWB SHALL BE FABRICATED TO IPC-6012, CLASS 2 AND WORKMANSHIP SHALL CONFORM TO IPC-A-600, CLASS 2, CURRENT REV. DIMENSIONING AND TOLERANCE OF PRINTED WIRING BOARD SHALL BE PER IPC-D-300 (CURRENT REV).
 3. BOARD MATERIAL TO BE MULTI-FUNCTIONAL FR-4 EXPOXY GLASS LAMINATE, AND SHALL MEET OR EXCEED MIL-P-13949. COLOR - NATURAL.
 4. BOARD MATERIAL AND CONSTRUCTION TO BE U.L. APPROVED AND MARKED ON THE FINISHED BOARD.
 5. MINIMUM COPPER WALL THICKNESS OF PLATED-THRU HOLES TO BE .001 INCHES
 6. OVERALL BOARD THICKNESS TO BE .062 +/- 10% AND APPLIES AFTER ALL LAMINATION AND PLATING PROCESSES. MEASURED FROM COPPER TO COPPER.
 7. MAX WARP AND TWIST TO BE .01 INCHES PER INCH.
 8. BOARD MUST BE ELECTRICALLY TESTED USING THE SUPPLIED IPC-D -356 NETLIST.
 9. PLATE ALL EXPOSED AREAS WITH ELECTROLESS IMMERSION GOLD, NICKEL 100 MICROINCHES THK. GOLD 2-6 MICROINCHES THK MIN.

- PROCESS NOTES:
1. APPLY LPI SOLDERMASK, BOTH SIDES, OVER BARE COPPER (SMOBC)
 COLOR: GREEN
 SOLDERMASK SHALL CONFORM TO IPC-SM-840, CLASS H, AND CURRENT REVISION. VIAS SHALL BE TENTED OR CLEARED BY SOLDERMASK PER ARTWORK. FABRICATION VENDOR IS ALLOWED TO ADJUST SOLDERMASK FEATURES AS NEEDED AS LONG AS SOLDERMASK DAMS ARE MAINTAINED BETWEEN ALL SMD PADS.
 2. SILKSCREEN BOTH SIDES USING LPI SILKSCREEN, COLOR: WHITE.
 PLACE ANY VENDOR SERIAL NUMBER ASSOCIATED TO PANEL ON BOTTM SIDE OF BOARD.



DRILL CHART: TOP to BOTTOM				
ALL UNITS ARE IN MILS				
FIGURE	SIZE	TOLERANCE	PLATED	QTY
+	12.0	+3.0/-3.0	PLATED	12
□	12.0	+3.0/-3.0	PLATED	116
○	32.0	+3.0/-3.0	PLATED	10
○	38.0	+3.0/-3.0	PLATED	14
○	42.0	+3.0/-3.0	PLATED	38
◇	45.0	+3.0/-3.0	PLATED	3
△	50.0	+3.0/-3.0	PLATED	6
○	65.0	+3.0/-3.0	PLATED	9
○	125.0	+3.0/-3.0	PLATED	4
□	40.0	+3.0/-3.0	NON-PLATED	3
⊗	35.0x28.0	+3.0/-3.0	PLATED	2
⊗	52.0x25.0	+3.0/-3.0	PLATED	2

maxim integrated

BOARD NAME: DS8500 EV KIT

P/N: PCB-00050-2-0 **DATE:** 02-19-2015

LAYER: DRILL TEMPLATE

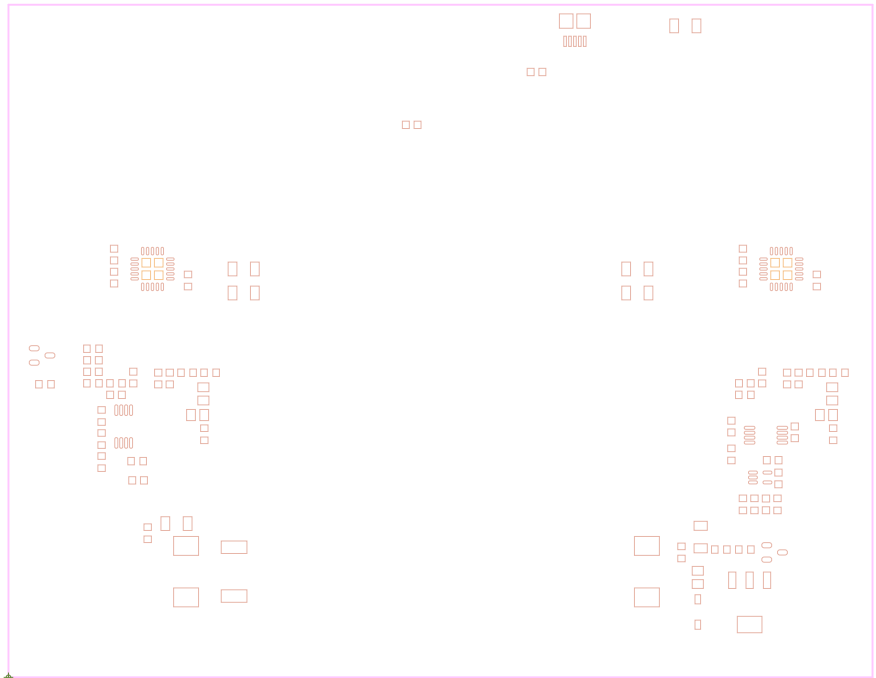

 maxim integrated	
BOARD NAME: DS8500 EV KIT	
P/N: PCB-00050-2-0	DATE: 02-19-2015
LAYER: PASTE MASK TOP	

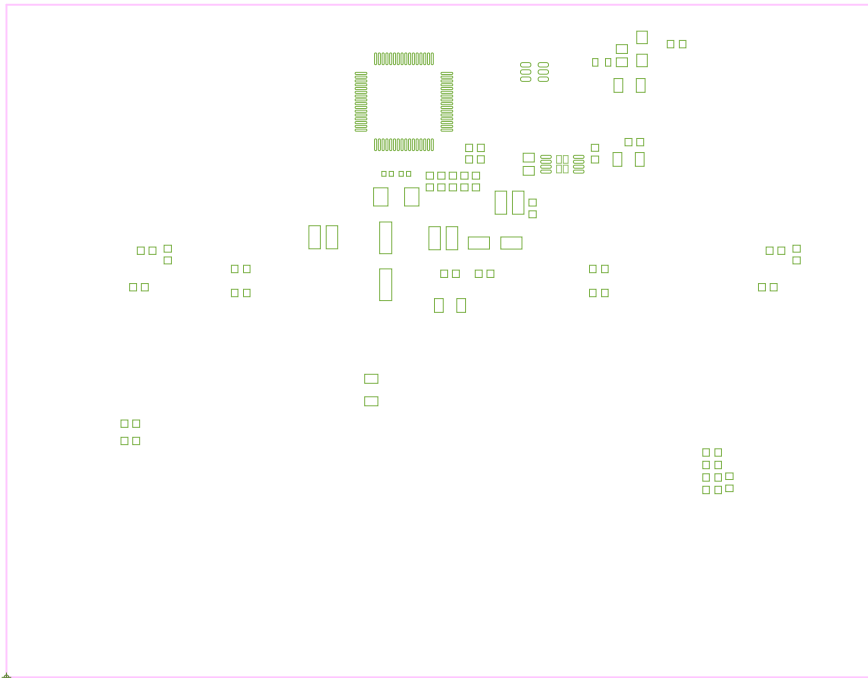

 maxim integrated	
BOARD NAME: DS8500 EV KIT	
P/N: PCB-00050-2-0	DATE: 02-19-2015
LAYER: PASTE MASK BOTTOM	



DS8500 EV KIT

- JP2 RXD M
- JP3 OCD M
- JP4 TXD M
- JP5 RTS M

C16

MICRO USB/POWER

- +3V3
- GND
- VBUS

POWER

- RXD F JP8
- OCD F JP9
- TXD F JP10
- RTS F JP11

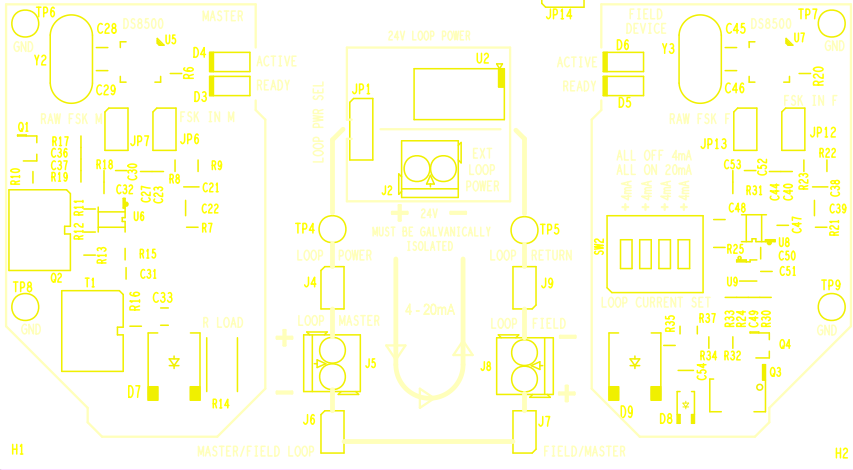

BOARD NAME: DS8500 EV KIT

P/N: PCB-00050-2-0

DATE: 02-19-2015

LAYER: SILKSCREEN TOP

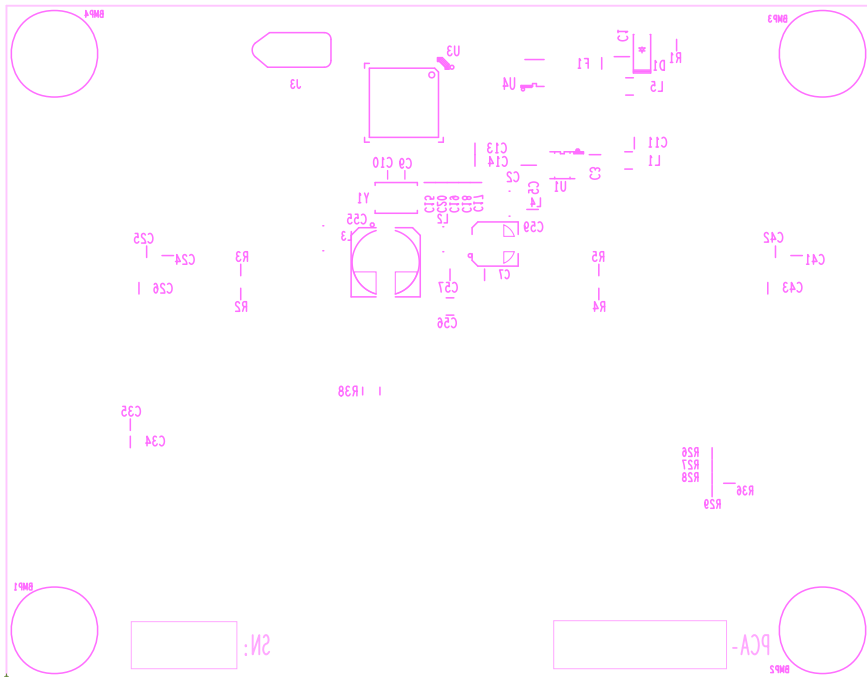

maxim
integrated

BOARD NAME: DS8500 EV KIT

P/N: PCB-00050-2-0

DATE: 02-19-2015

LAYER: SILKSCREEN BOTTOM

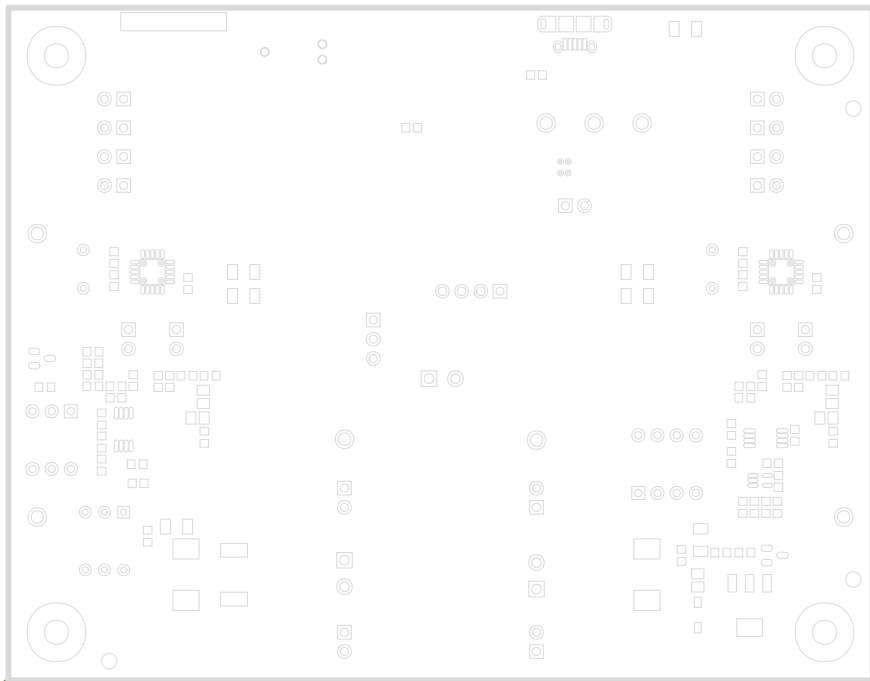

 maxim integrated	
BOARD NAME: DS8500 EV KIT	
P/N: PCB-00050-2-0	DATE: 02-19-2015
LAYER: SOLDER MASK TOP	

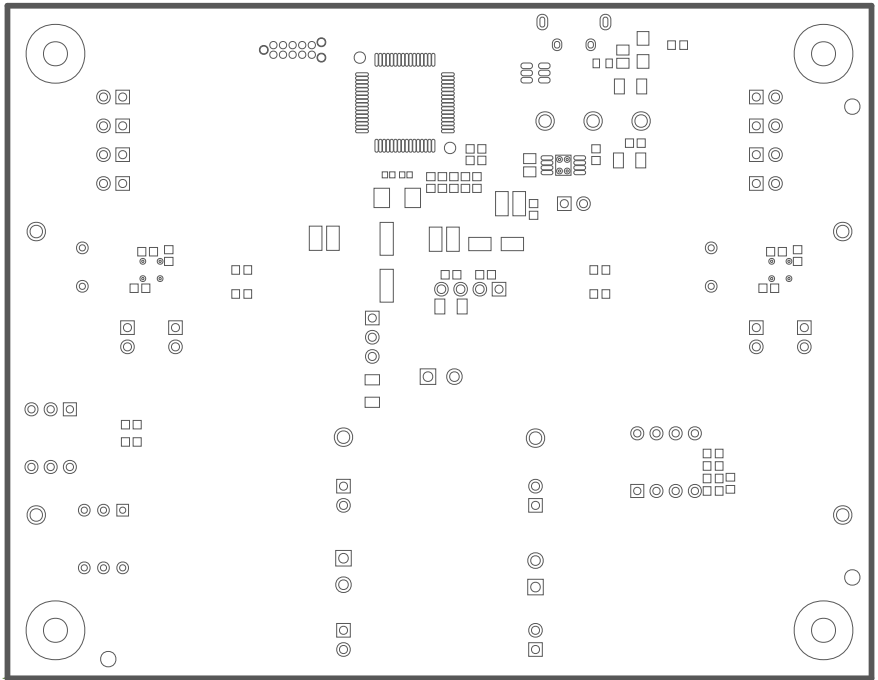

 maxim integrated		
BOARD NAME: DS8500 EV KIT		
P/N: PCB-00050-2-0		DATE: 02-19-2015
LAYER: SOLDER MASK BOTTOM		

Mouser Electronics

Authorized Distributor

Click to View Pricing, Inventory, Delivery & Lifecycle Information:

[Maxim Integrated:](#)

[DS8500-KIT#](#)