

Surface Mount 1910.00MHz SAW Filter

AFS20A20-1910.00-T3

Moisture Sensitivity Level (MSL) – This product is Hermetically Sealed and not Moisture Sensitive - MSL = N/A: Not Applicable



RoHS
Compliant

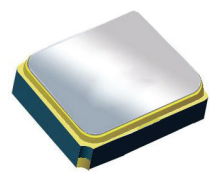

2.0 x 1.6 x 0.9 mm

FEATURES:

- 2.0 x 1.6 x 0.9 mm low profile SMT package
- Low Insertion loss
- Excellent selectivity with high out-of-band rejection

APPLICATIONS:

- Wireless Communication
- Remote Control
- Cellular Phones

ELECTRICAL SPECIFICATIONS:

Maximum Ratings

Item	Value
Input Power Level	+15 dBm max.
DC Permissive Voltage	5.0V DC max.
Operating Temperature Range	0°C to + 70°C
Storage Temperature Range	-30°C to + 85°C

Parameters	Minimum	Typical	Maximum	Units	Notes
Center Frequency (f_c)		1910.00		MHz	
Insertion Loss (IL)		1.20	1.80	dB	(1900 ~ 1920MHz)
Effective Bandwidth		20.00		MHz	
Amplitude Ripple		0.4	2.00	dB	(1900 ~ 1920MHz)
Worst-Case Input / Output Return Loss		16.0	8.0	dB	(1900 ~ 1920MHz)
Stop-band Attenuation (Referenced to 0.0 dB)	15	32		dB	(925 ~ 1600MHz)
	25	28			(1600 ~ 1825MHz)
	20	29			(1825 ~ 1840MHz)
	10	35			(1840 ~ 1850MHz)
	5	13.50			(1850 ~ 1880MHz)
	25	32			(2040 ~ 2660MHz)
	25	33			(2660 ~ 3000MHz)
Source Impedance (Z_s)		50		Ω	See note # 1
Load Impedance (Z_L)		50		Ω	See note # 1

Note #1: No matching network required for operation into 50 Ω 's

TEST CIRCUIT:

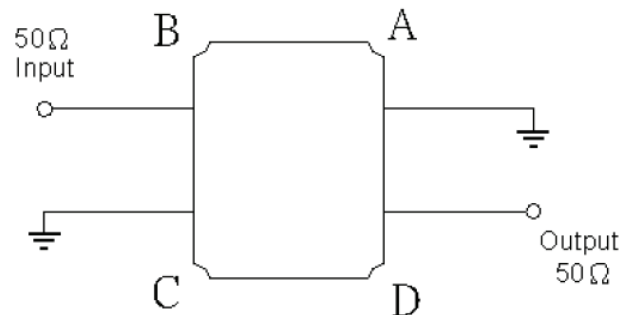

Surface Mount 1910.00MHz SAW Filter

AFS20A20-1910.00-T3



RoHS
Compliant

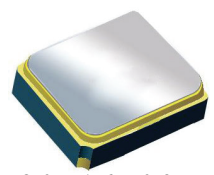

2.0 x 1.6 x 0.9 mm

OUTLINE DIMENSIONS:

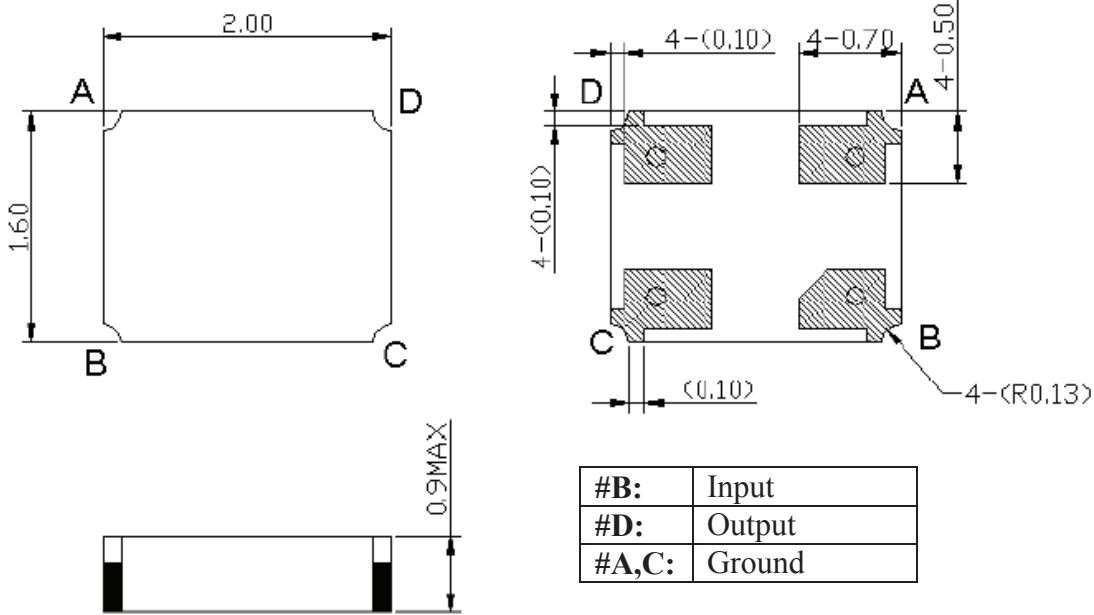

*All Dimensions are in mm

Recommended Land Pattern:

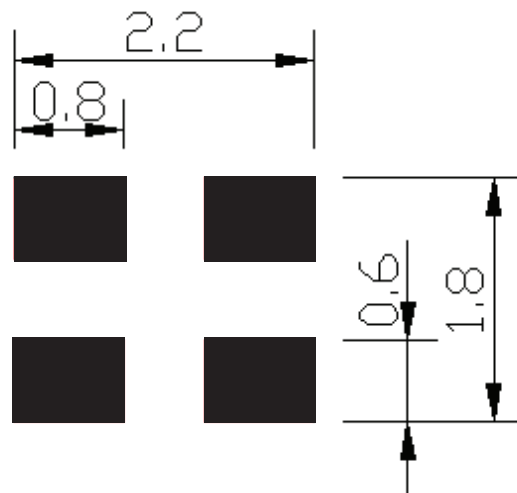

Surface Mount 1910.00MHz SAW Filter

AFS20A20-1910.00-T3



RoHS
Compliant

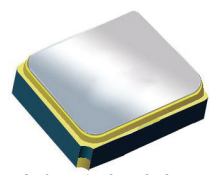

2.0 x 1.6 x 0.9 mm

FREQUENCY CHARACTERISTICS:

Filter Frequency Response (Narrowband)

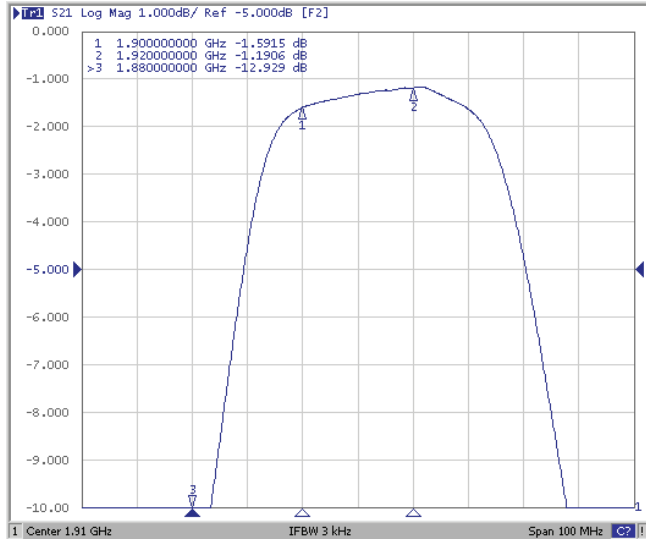

Filter Frequency Response (Wideband)

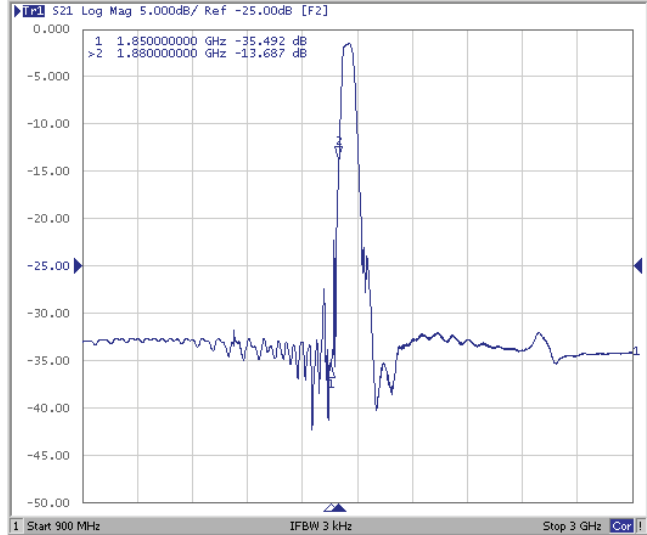

REFLECTION FUNCTIONS:

S11

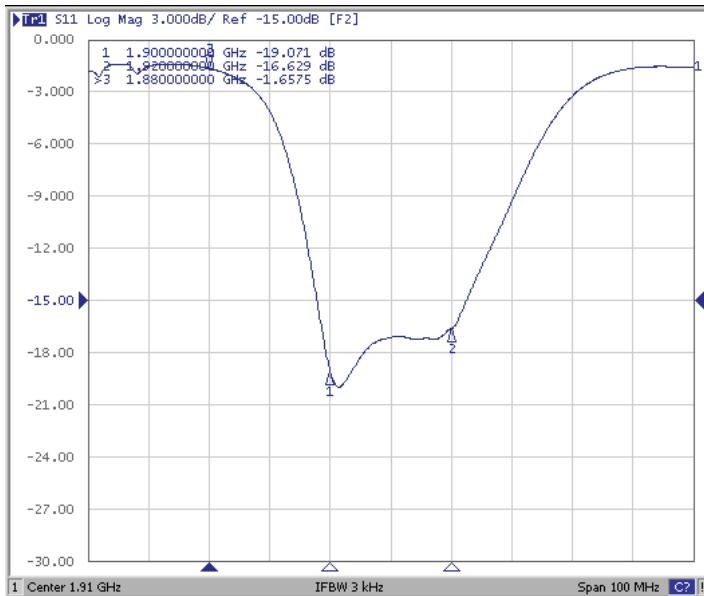

S22

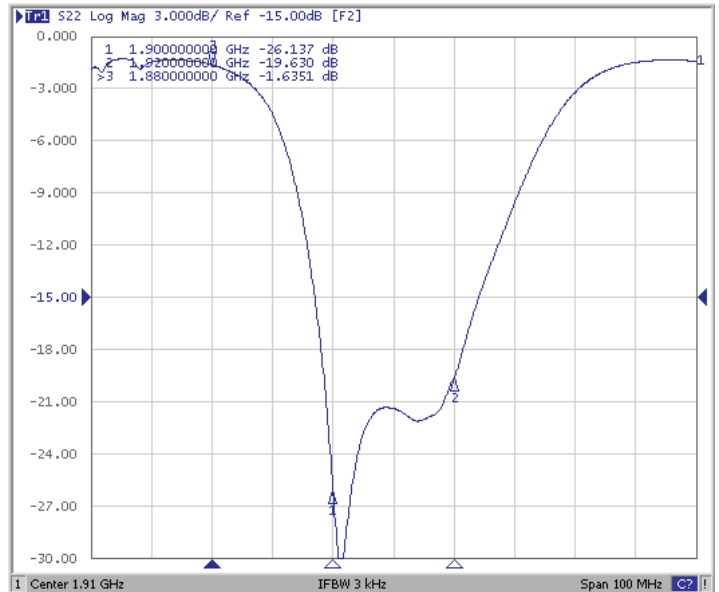

Surface Mount 1910.00MHz SAW Filter

AFS20A20-1910.00-T3



RoHS
Compliant

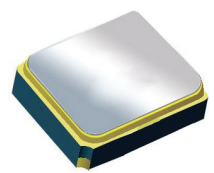

2.0 x 1.6 x 0.9 mm

REFLOW PROFILE:

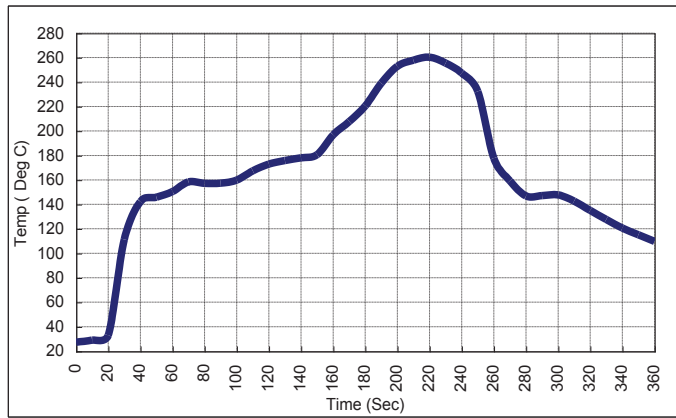

PACKAGING: 3000 Units/Reel "T2" parts (2k/reel) are no longer available effective 01/01/2013

Reel Count : 7" = 3k units

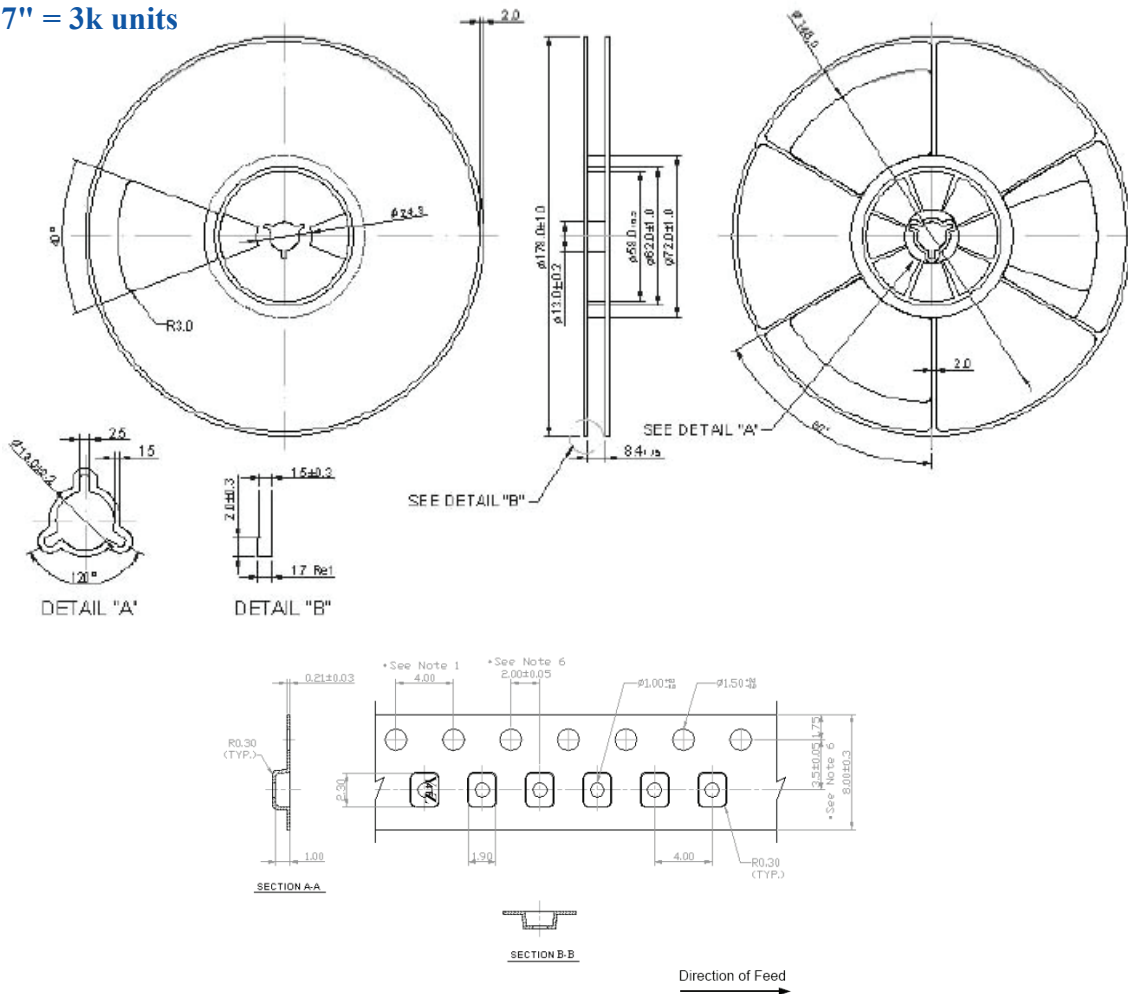

ATTENTION: Abracon Corporation's products are COTS – Commercial-Off-The-Shelf products; suitable for Commercial, Industrial and, where designated, Automotive Applications. Abracon's products are not specifically designed for Military, Aviation, Aerospace, Life-dependant Medical applications or any application requiring high reliability where component failure could result in loss of life and/or property. For applications requiring high reliability and/or presenting an extreme operating environment, written consent and authorization from Abracon Corporation is required. Please contact Abracon Corporation for more information.

ABRACON IS
ISO 9001:2008
CERTIFIED



Visit www.abracon.com for Terms & Conditions of Sale
30332 Esperanza, Rancho Santa Margarita, California 92688
tel 949-546-8000 | fax 949-546-8001 | www.abracon.com

Revised: 04.16.13

Mouser Electronics

Authorized Distributor

Click to View Pricing, Inventory, Delivery & Lifecycle Information:

[ABRACON:](#)

[AFS20A20-1910.00-T3](#)