

PLEASE CHECK WWW.MOLEX.COM FOR LATEST PART INFORMATION

Part Number: [5018762840](#)
Status: **Active**
Overview: iGrid Wire-to-Board Dual-Row System
Description: 2.00mm Pitch iGrid Wire-to-Board Header, Dual Row, Right Angle, 28 Circuits

Documents:

3D Model	Application Specification 5016460000-A01 (PDF)
Drawing (PDF)	Packaging Specification SPK-501876-001-001 (PDF)
Product Specification PS-501646-001-001 (PDF)	RoHS Certificate of Compliance (PDF)
Application Specification 5016460000-A00 (PDF)	

Agency Certification

UL E29179

General

Product Family	PCB Headers
Series	501876
Application	Signal, Wire-to-Board
Data Load Status	Post Go-Live Rev. Not Verified
Made From	5018730028, 5018740028, 5018752820
Overview	iGrid Wire-to-Board Dual-Row System
Product Name	iGrid
UPC	822350171052

Physical

Breakaway	No
Circuits (Loaded)	28
Circuits (maximum)	28
Color - Resin	Natural
Durability (mating cycles max)	30
Flammability	94V-0
Glow-Wire Capable	No
Keying to Mating Part	Yes
Lock to Mating Part	Yes
Material - Metal	Brass
Material - Plating Mating	Tin
Material - Plating Termination	Tin
Material - Resin	Nylon
Net Weight	3089.000/mg
Number of Rows	2
Orientation	Right Angle
PC Tail Length	3.20mm
PCB Locator	No
PCB Retention	None
PCB Thickness - Recommended	1.20mm, 1.60mm
Packaging Type	Tray
Pitch - Mating Interface	2.00mm
Polarized to Mating Part	Yes
Polarized to PCB	No
Stackable	No
Surface Mount Compatible (SMC)	No
Temperature Range - Operating	-40°C to +105°C
Termination Interface: Style	Through Hole

Electrical

Current - Maximum per Contact	2.0A
Voltage - Maximum	250V AC (RMS)/DC

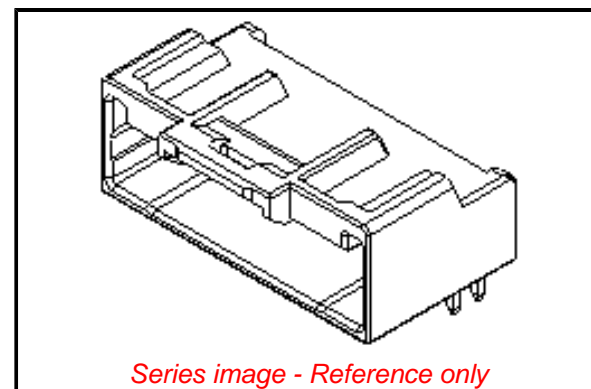

Series image - Reference only

EU ELV

Not Relevant

EU RoHS

Compliant

REACH SVHC

Not Contained Per
-ED/01/2018 (15
January 2018)

Halogen-Free

Status

Not Low-Halogen

Need more information on product environmental compliance?

Email productcompliance@molex.com
Please visit the [Contact Us](#) section for any non-product compliance questions.

China ROHS

ELV

RoHS Phthalates

China RoHS

Green Image

Not Relevant

Not Contained

Search Parts in this Series

[501876](#) Series

Mates With

[501646](#) Housing, [501647](#) Crimp Terminal
22-26 AWG, [501648](#) Crimp Terminal 26-28
AWG

Material Info

Reference - Drawing Numbers

Application Specification	5016460000-A00, 5016460000-A01
Packaging Specification	SPK-501876-001-001
Product Specification	PS-501646-001-001
Sales Drawing	SD-501876-001

This document was generated on 03/02/2018

PLEASE CHECK WWW.MOLEX.COM FOR LATEST PART INFORMATION

Mouser Electronics

Authorized Distributor

Click to View Pricing, Inventory, Delivery & Lifecycle Information:

[Molex:](#)

[501876-2840](#)