

Type TE Series

Key Features

Up to 2500W
Power rating in
free air

Flameproof
construction –
UL94V coating

RoHS compliant

Custom
terminations /
leads available



Applications

Large electrical
and production
machinery

Load test
simulation

Motor start /
stop cycles

Dynamic braking

Equipment
discharge

TE Connectivity is a leading supplier of standard and custom-designed power resistors for industrial, control and general- purpose applications.

The TE range of flameproof coated tubular ceramic core resistors use both standard and edge wound (corrugated) winding methods to improve power handling capability. Designed for heavy duty machinery, electrical equipment, motor control etc. requiring stability and reliability.

Characteristics – Electrical

| | |
|---------------------------------------|------------------------------------|
| Power rating @70°C in free air | 50W – 2500W (see table) |
| Resistance range | See table |
| Selection series | E12 |
| Tolerance | ±5% ±10% |
| Temperature Coefficient of resistance | <20Ω ±400PPM/°C ≥20Ω ±300PPM/°C |
| Operating temperature range | -55 ~ +155°C |
| Short term overload | 3 x rated power / 5 seconds |
| Dielectric strength | 2500VAC Min. |
| Insulation resistance | DC500V 20MΩ min. |

Specifications – Electrical

| Power Rating | Resistance Value | Tolerance | Appearance |
|--------------|------------------|-----------|------------|
| 50W | R10 ~ 2K7 | ±5% ±10% | Smooth |
| 60W | R10 ~ 2K7 | ±5% ±10% | Smooth |
| 80W | R10 ~ 2K7 | ±5% ±10% | Smooth |
| 100W | 1R0 ~ 2K7 | ±5% ±10% | Smooth |
| 120W | 1R0 ~ 2K7 | ±5% ±10% | Smooth |
| 150W | 1R0 ~ 2K7 | ±5% ±10% | Smooth |
| 200W | 1R0 ~ 9R1 | ±5% ±10% | Ribbed |
| | 10R ~ 2K7 | ±5% ±10% | Smooth |
| 300W | 1R0 ~ 9R1 | ±5% ±10% | Ribbed |
| | 10R ~ 2K7 | ±5% ±10% | Smooth |
| 400W | 1R0 ~ 15R | ±5% ±10% | Ribbed |
| | 16R ~ 2K7 | ±5% ±10% | Smooth |
| 500W | 1R0 ~ 20R | ±5% ±10% | Ribbed |
| | 21R ~ 2K7 | ±5% ±10% | Smooth |
| 600W | 1R0 ~ 20R | ±5% ±10% | Ribbed |
| | 21R ~ 2K7 | ±5% ±10% | Smooth |
| 750W | 1R0 ~ 75R | ±5% ±10% | Ribbed |
| | 76R ~ 2K7 | ±5% ±10% | Smooth |
| 1000W | 1R0 ~ 100R | ±5% ±10% | Ribbed |
| | 101R ~ 2K7 | ±5% ±10% | Smooth |
| 1200W | 1R0 ~ 100R | ±5% ±10% | Ribbed |
| | 101R ~ 2K7 | ±5% ±10% | Smooth |
| 1500W | 1R0 ~ 120R | ±5% ±10% | Ribbed |
| | 121R ~ 2K7 | ±5% ±10% | Smooth |
| 2000W | 1R0 ~ 120R | ±5% ±10% | Ribbed |
| | 121R ~ 2K7 | ±5% ±10% | Smooth |
| 2500W | 1R0 ~ 120R | ±5% ±10% | Ribbed |
| | 121R ~ 2K7 | ±5% ±10% | Smooth |

Voltage rating:

Resistors shall have a rated direct-current (DC) continuous working voltage or an approximate sine-wave root-mean-square (RMS) alternating-current (AC) continuous working voltage at commercial line frequency and waveform corresponding to the power rating, as determined from the following formula:

$$RCWV = \sqrt{P \times R}$$

Where : RCWV = Rated DC or RMS AC continuous working voltage at commercial-line frequency and waveform (volt)

P = Power Rating (watt)

R = Nominal Resistance (ohm)

Derating Curve

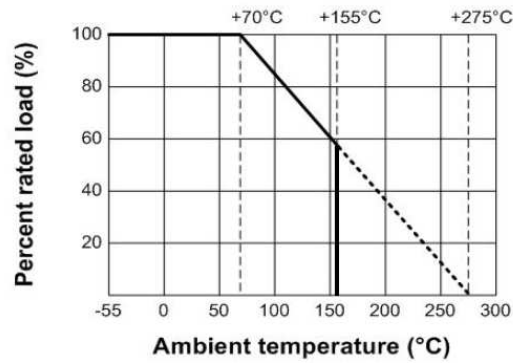

Temperature Rise Chart

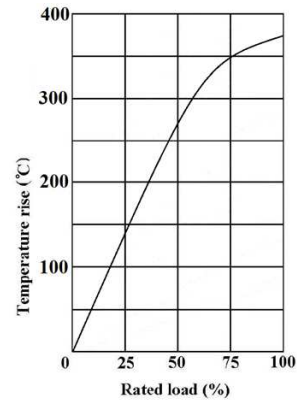

Construction:

Smooth:

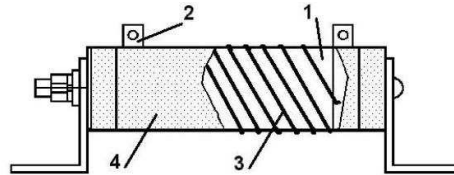

Ribbed:

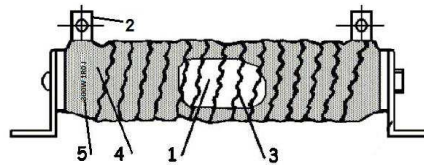

| No. | Name | Material | Material Generic Name |
|-----|-----------------|--|---|
| 1 | Basic Body | Rod Type Ceramics | Al ₂ O ₃ , SiO ₂ |
| 2 | Terminal | Tin plated terminal cap | Fe : 73%, Mn : 21%, C : 5% |
| 3 | Resistance Wire | Ni-Cr or Cu-Ni Alloy | Ni-Cr or Cu-Ni Alloy |
| 4 | Coating | Insulated and non-flame paint (Color: Green) | Non-Flame paint UL94V |
| 5 | Marking | Marking Ink | --- |

Marking

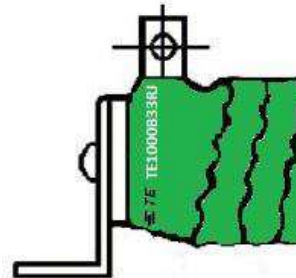

Environmental Characteristics:

| Characteristics | Limits | Test Methods (JIS C 5201-1) |
|------------------------------|--|--|
| Temperature Coefficient | <20Ω : ± 400 PPM/°C Max. ≥20Ω : ± 300 PPM/°C Max. | Natural Resistance change per temperature degree centigrade. $R_2 - R_1$ ----- x10 ⁶ (PPM/°C) $R_1(t_2 - t_1)$ R ₁ : Resistance value at room temperature (t ₁) R ₂ : Resistance value at room temperature +100°C (t ₂) (Sub-clause 4.8) |
| Short term overload | ±(2% + 0.05Ω) Max. with no evidence of mechanical damage | Permanent resistance change after the application of a potential of 3 x RCWV for 5 seconds (Sub-clause 4.13) |
| Terminal Strength | No evidence of mechanical damage | Direct load : Resistance to a 2.5 kgs direct load for 10 secs. in the direction of the longitudinal axis of the terminal leads Twist Test : Terminal leads shall be bent through 90 ° at a point of about 6mm from the body of the resistor and shall be rotated through 360° about the original axis of the bent terminal in alternating direction for a total of 3 rotations (Sub-clause 4.16) |
| Solderability | 95 % coverage Min. | The area covered with a new smooth, clean, shiny and continuous surface free from concentrated pinholes. Test temp. of solder : 245°C ± 3°C Dwell time in solder : 2 ~ 3 seconds (Sub-clause 4.17) |
| Soldering Temp. Reference | Electrical Characteristics shall be satisfied without distinct deformation in appearance. (95% coverage Min.) | Terminals immersed into solder bath to 3.2 ~ 4.8mm from the body. Permanent resistance change shall be checked. <u>Wave soldering condition (2 cycles max.)</u> Pre-heat : 100 ~ 120 °C, 30 ± 5sec. Suggested solder temp.: 235 ~ 255 °C, 10 sec. (max.) Peak temp.: 260 °C <u>Hand soldering condition:</u> Hand Soldering bit temp. : 380 ± 10 °C Dwell time in solder : 3 +1/-0 sec. |
| Resistance to soldering heat | Resistance change rate ±(1%+0.05Ω) with no evidence of mechanical damage | Permanent resistance change when terminals immersed to 3.2 ~ 4.8mm from body in 350°C ±10°C solder for 3±0.5 seconds Sub-clause 4.18 |
| Load life in humidity | Resistance change rate ±(5%+ 0.05Ω) Max. with no evidence of mechanical damage | Resistance change after 1,000 hours (1.5 hours "on", 0.5 hour "off") at RCWV in a humidity test chamber controlled at 40 °C± 2 °C and 90 to 95 % relative humidity (Sub-clause 4.24.2.1) |
| Load Life | Resistance change rate ±(5%+ 0.05Ω) Max. with no evidence of mechanical damage | Permanent resistance change after 1,000 hours operating at RCWV with duty cycle of (1.5 hours "on", 0.5 hour "off") at 70°C ± 2°C ambient (Sub-clause 4.25.1) |

Dimensions:

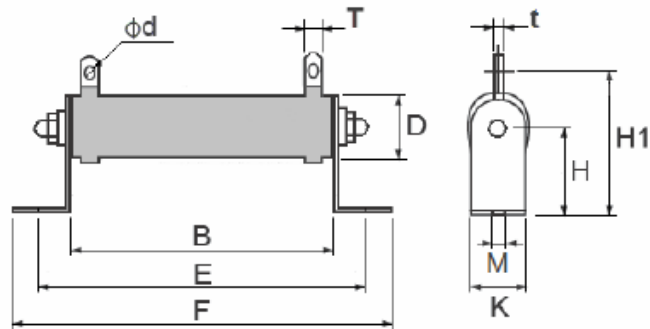

| Power rating | Dimension (mm) | | | | | | | | | | |
|--------------|----------------|-----|-----|-----|-----|------|-------|-----|-------|-------|---------|
| | B±2 | E±5 | F±3 | D±2 | H±1 | H1±3 | M±0.5 | K±1 | T±0.5 | t±0.5 | Ød ±0.5 |
| 50W | 102 | 124 | 146 | 28 | 28 | 61 | 6.5 | 28 | 8 | 1.8 | 4.3 |
| 60W | 102 | 124 | 146 | 28 | 28 | 61 | 6.5 | 28 | 8 | 1.8 | 4.3 |
| 80W | 152 | 174 | 196 | 28 | 28 | 61 | 6.5 | 28 | 8 | 1.8 | 4.3 |
| 100W | 182 | 204 | 226 | 28 | 28 | 61 | 6.5 | 28 | 8 | 1.8 | 4.3 |
| 120W | 182 | 204 | 226 | 28 | 28 | 61 | 6.5 | 28 | 8 | 1.8 | 4.3 |
| 150W | 195 | 217 | 239 | 40 | 41 | 81 | 8 | 40 | 10 | 1.8 | 5.5 |
| 200W | 195 | 217 | 239 | 40 | 41 | 81 | 8 | 40 | 10 | 1.8 | 5.5 |
| 300W | 282 | 304 | 326 | 40 | 41 | 81 | 8 | 40 | 10 | 1.8 | 5.5 |
| 400W | 282 | 304 | 326 | 40 | 41 | 81 | 8 | 40 | 10 | 1.8 | 5.5 |
| 500W | 316 | 338 | 360 | 50 | 45 | 101 | 8 | 50 | 16 | 1.8 | 6.5 |
| 600W | 345 | 367 | 389 | 40 | 41 | 81 | 8 | 40 | 10 | 1.8 | 5.5 |
| 750W | 316 | 338 | 360 | 50 | 45 | 101 | 8 | 50 | 16 | 1.8 | 6.5 |
| 1000W | 300 | 325 | 350 | 60 | 60 | 119 | 8.5 | 60 | 15 | 2 | 6.5 |
| 1200W | 415 | 440 | 465 | 60 | 60 | 119 | 8.5 | 60 | 15 | 2 | 6.5 |
| 1500W | 415 | 440 | 465 | 60 | 60 | 119 | 8.5 | 60 | 15 | 2 | 6.5 |
| 2000W | 510 | 535 | 560 | 60 | 60 | 119 | 8.5 | 60 | 15 | 2 | 6.5 |
| 2500W | 600 | 625 | 650 | 60 | 60 | 119 | 8.5 | 60 | 15 | 2 | 6.5 |

Label

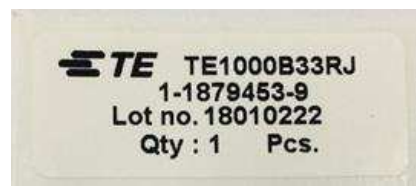

How To Order

| TE | 50 | B | 1K0 | J |
|------------------------------------|--|---|---|---------------------|
| Common Part | Power Rating | Mounting | Resistance Value | Tolerance |
| TE – High Power Wirewound Resistor | 50 50W 60 60W 80 80W 100 100W etc. | A – No Bracket B – With Bracket (standard) | 100R - 100Ω 1K0 - 1000Ω 10K – 10,000Ω | J - ±5% K - ±10% |