

# BGA6589

MMIC wideband medium power amplifier

Rev. 3 — 28 November 2011

Product data sheet

## 1. Product profile

### 1.1 General description

The BGA6589 is a silicon Monolithic Microwave Integrated Circuit (MMIC) wideband medium power amplifier with internal matching circuit in a 3-pin SOT89 plastic low thermal resistance SMD package.

The BGA6x89 series of medium power gain blocks are resistive feedback Darlington configured amplifiers. Resistive feedback provides large bandwidth with high accuracy.

#### CAUTION



This device is sensitive to ElectroStatic Discharge (ESD). Therefore care should be taken during transport and handling.

### 1.2 Features and benefits

- Broadband 50  $\Omega$  gain block
- 20 dBm output power
- SOT89 package
- Single supply voltage needed

### 1.3 Applications

- Broadband medium power gain blocks
- Small signal high linearity amplifiers
- Variable gain and high output power in combination with the BGA2031
- Cellular, PCS and CDPD
- IF/RF buffer amplifier
- Wireless data SONET
- Oscillator amplifier, final PA
- Drivers for CATV amplifier



## 1.4 Quick reference data

Table 1. Quick reference data

Symbol	Parameter	Conditions	Min	Typ	Max	Unit
$V_D$	DC device voltage	on pin 1; $I_S = 81$ mA	-	4.8	-	V
$I_S$	DC supply current	$V_S = 9$ V; $R_{bias} = 51$ $\Omega$ ; $T_j = 25$ °C	-	81	-	mA
$ S_{21} ^2$	insertion power gain	$f = 1950$ MHz	-	17	-	dB
NF	noise figure	$f = 1950$ MHz	-	3.3	-	dB
$P_{L1dB}$	load power at 1 dB gain compression	$f = 850$ MHz	-	21	-	dBm
		$f = 1950$ MHz	-	20	-	dBm

## 2. Pinning information

Table 2. Pinning

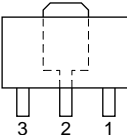
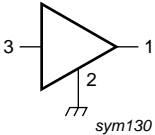
Pin	Description	Simplified outline	Graphic symbol
1	RF_OUT/BIAS		 sym130
2	GND		
3	RF_IN		

## 3. Ordering information

Table 3. Ordering information

Type number	Package		Version
	Name	Description	
BGA6589	SC-62	plastic surface-mounted package; collector pad for good heat transfer; 3 leads	SOT89

## 4. Marking

Table 4. Marking codes

Type number	Marking code
BGA6589	5A

## 5. Limiting values

**Table 5. Limiting values**

In accordance with the Absolute Maximum Rating System (IEC 60134).

Symbol	Parameter	Conditions	Min	Max	Unit
$V_D$	DC device voltage	on pin 1; RF input AC coupled	-	6	V
$I_S$	DC supply current		-	150	mA
$P_{tot}$	total power dissipation	$T_{sp} \leq 70\text{ °C}$	[1]	800	mW
$T_{stg}$	storage temperature		-65	+150	°C
$T_j$	junction temperature		-	150	°C
$P_D$	drive power		-	15	dBm
$V_{ESD}$	electrostatic discharge voltage	Human Body Model (HBM); According JEDEC standard 22-A114E	-	200	V
		Charged Device Model (CDM); According JEDEC standard 22-C101B	-	2	kV

[1]  $T_{sp}$  is the temperature at the solder point of the ground lead, pin 2.

## 6. Thermal characteristics

**Table 6. Thermal characteristics**

Symbol	Parameter	Conditions	Typ	Unit	
$R_{th(j-sp)}$	thermal resistance from junction to solder point	$T_{sp} \leq 70\text{ °C}$	[1]	100	K/W

[1]  $T_{sp}$  is the temperature at the solder point of the ground lead, pin 2.

## 7. Characteristics

**Table 7. Static characteristics**

$V_S = 9\text{ V}$ ;  $T_j = 25\text{ °C}$ ;  $R_{bias} = 51\ \Omega$ . [1]

Symbol	Parameter	Conditions	Min	Typ	Max	Unit
$V_D$	DC device voltage	on pin 1; $I_S = 81\text{ mA}$	-	4.8	-	V
$I_S$	DC supply current		73	81	89	mA

[1]  $V_S$  = DC operating supply voltage applied to  $R_{bias}$ ; see [Figure 10](#).

**Table 8. Characteristics**

$V_S = 9\text{ V}$ ;  $I_S = 81\text{ mA}$ ;  $T_{amb} = 25\text{ °C}$ ;  $R_{bias} = 51\ \Omega$ ;  $IP3_{(out)}$  tone spacing = 1 MHz;  $P_L = 0\text{ dBm}$  per tone (see [Figure 10](#));  $Z_L = Z_S = 50\ \Omega$ ; unless otherwise specified.

Symbol	Parameter	Conditions	Min	Typ	Max	Unit
$ S_{21} ^2$	insertion power gain	$f = 850\text{ MHz}$	-	22	-	dB
		$f = 1950\text{ MHz}$	-	17	-	dB
		$f = 2500\text{ MHz}$	-	15	-	dB
$R_{LIN}$	return losses input	$f = 850\text{ MHz}$	-	9	-	dB
		$f = 1950\text{ MHz}$	-	11	-	dB
		$f = 2500\text{ MHz}$	-	15	-	dB

**Table 8. Characteristics ...continued**

$V_S = 9\text{ V}$ ;  $I_S = 81\text{ mA}$ ;  $T_{amb} = 25\text{ °C}$ ;  $R_{bias} = 51\ \Omega$ ;  $IP3_{(out)}$  tone spacing = 1 MHz;  $P_L = 0\text{ dBm}$  per tone (see Figure 10);  $Z_L = Z_S = 50\ \Omega$ ; unless otherwise specified.

Symbol	Parameter	Conditions	Min	Typ	Max	Unit
R <sub>LOUT</sub>	return losses output	f = 850 MHz	-	10	-	dB
		f = 1950 MHz	-	13	-	dB
		f = 2500 MHz	-	13	-	dB
NF	noise figure	f = 850 MHz	-	3.0	-	dB
		f = 1950 MHz	-	3.3	-	dB
		f = 2500 MHz	-	3.4	-	dB
K	stability factor	f = 850 MHz	-	1.1	-	
		f = 2500 MHz	-	1.1	-	
P <sub>L1dB</sub>	load power at 1 dB gain compression	f = 850 MHz	-	21	-	dBm
		f = 1950 MHz	-	20	-	dBm
IP <sub>3(in)</sub>	input intercept point	f = 850 MHz	-	11	-	dBm
		f = 2500 MHz	-	15	-	dBm
IP <sub>3(out)</sub>	output intercept point	f = 850 MHz	-	33	-	dBm
		f = 2500 MHz	-	30	-	dBm

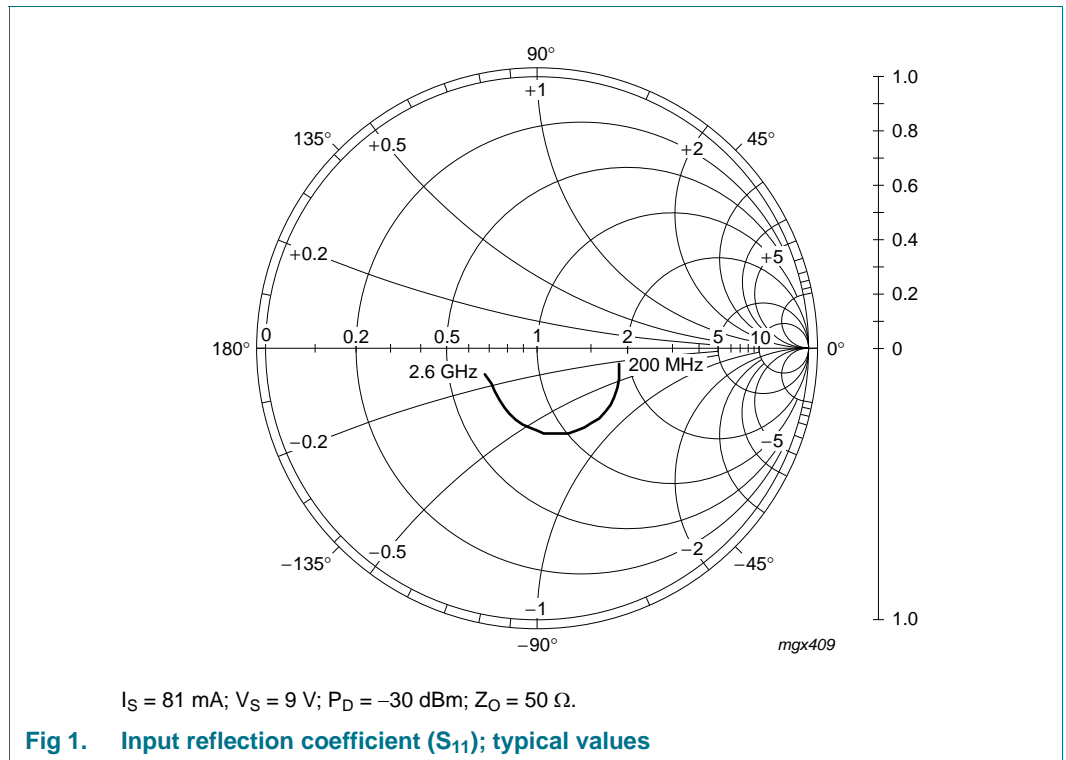

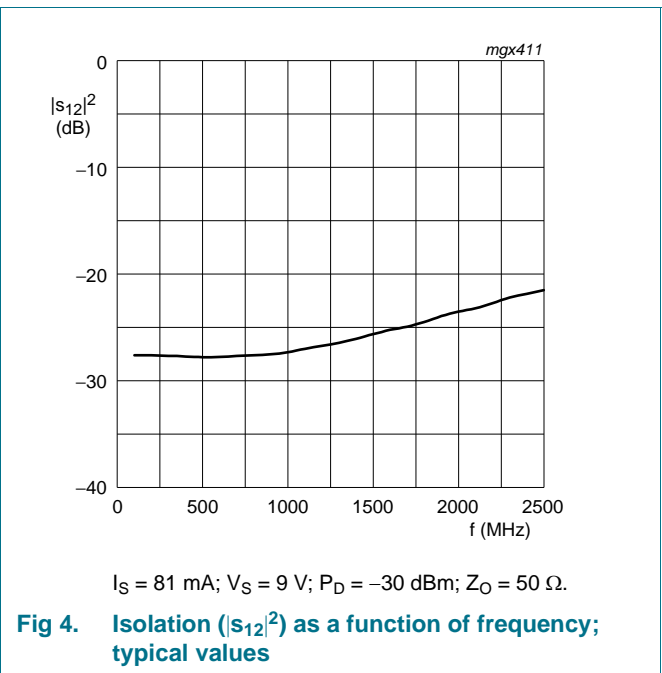
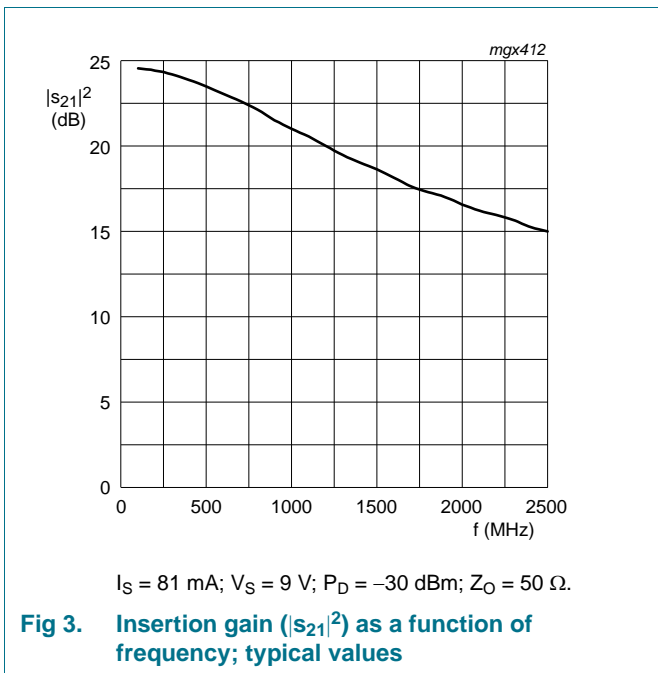
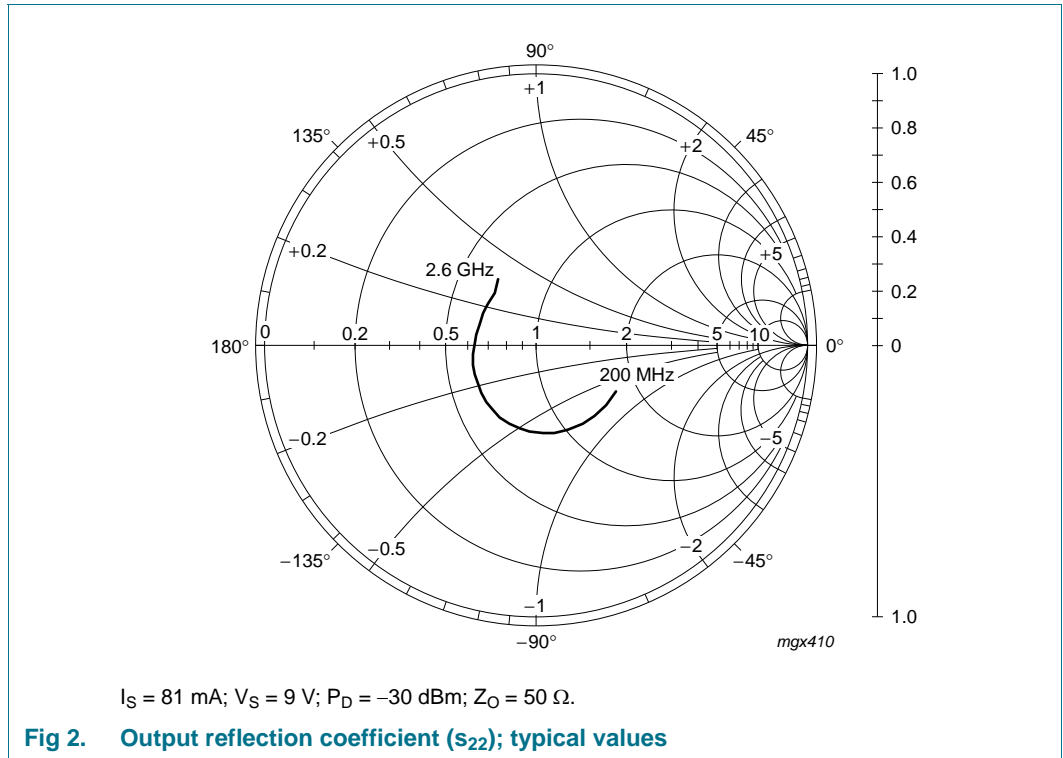

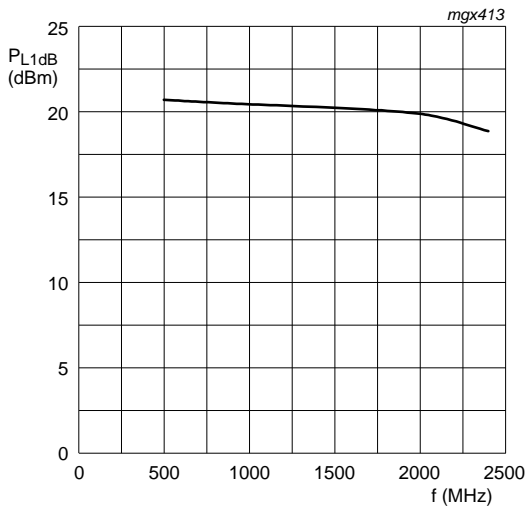

$I_S = 81 \text{ mA}$ ;  $V_S = 9 \text{ V}$ ;  $Z_O = 50 \Omega$ .

**Fig 5. Load power as a function of frequency; typical values**

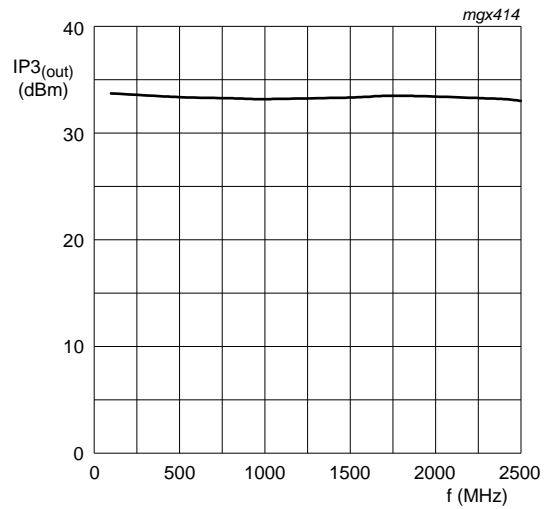

$I_S = 81 \text{ mA}$ ;  $V_S = 9 \text{ V}$ ;  $P_L = 0 \text{ dBm}$ ;  $Z_O = 50 \Omega$ .

**Fig 6. Output intercept as a function of frequency; typical values**

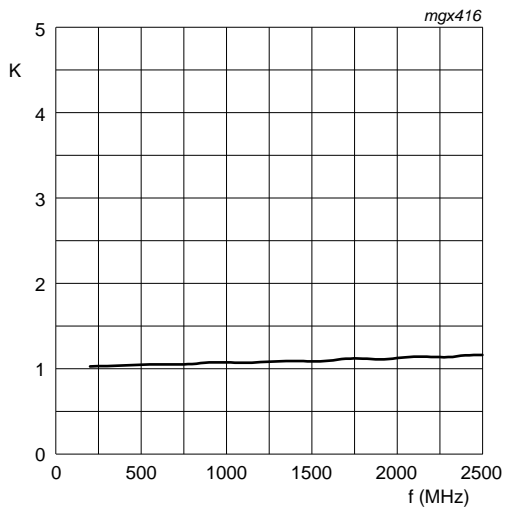

$I_S = 81 \text{ mA}$ ;  $V_S = 9 \text{ V}$ ;  $Z_O = 50 \Omega$ .

**Fig 7. Stability factor as a function of frequency; typical values**

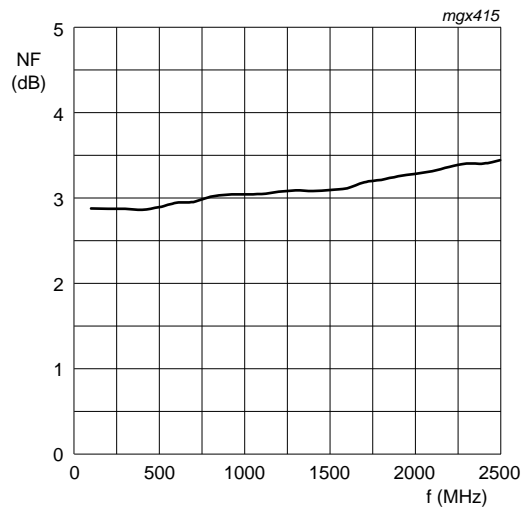

$I_S = 81 \text{ mA}$ ;  $V_S = 9 \text{ V}$ ;  $Z_O = 50 \Omega$ .

**Fig 8. Noise figure as a function of frequency; typical values**

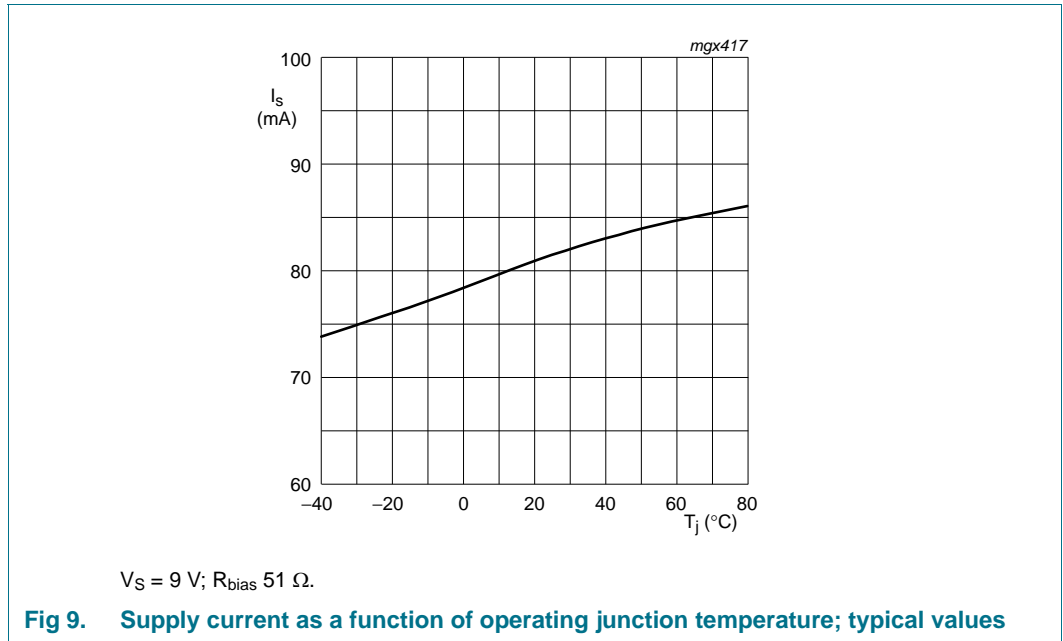

## 8. Application information

Figure 10 shows a typical application circuit for the BGA6589 MMIC. The device is internally matched to  $50\ \Omega$ , and therefore does not require any external matching. The value of the input and output DC blocking capacitors C1 and C2 depends on the operating frequency; see Table 9. Capacitors C1 and C2 are used in conjunction with L1 and C3 to fine tune the input and output impedance. Capacitor C4 is a supply decoupling capacitor. A  $1\ \mu\text{F}$  capacitor (C5) can be added for optimum supply decoupling. The external components should be placed as close as possible to the MMIC. When using via holes, use multiple via holes per pin in order to limit ground path induction. Resistor R1 is a bias resistor providing DC current stability with temperature.

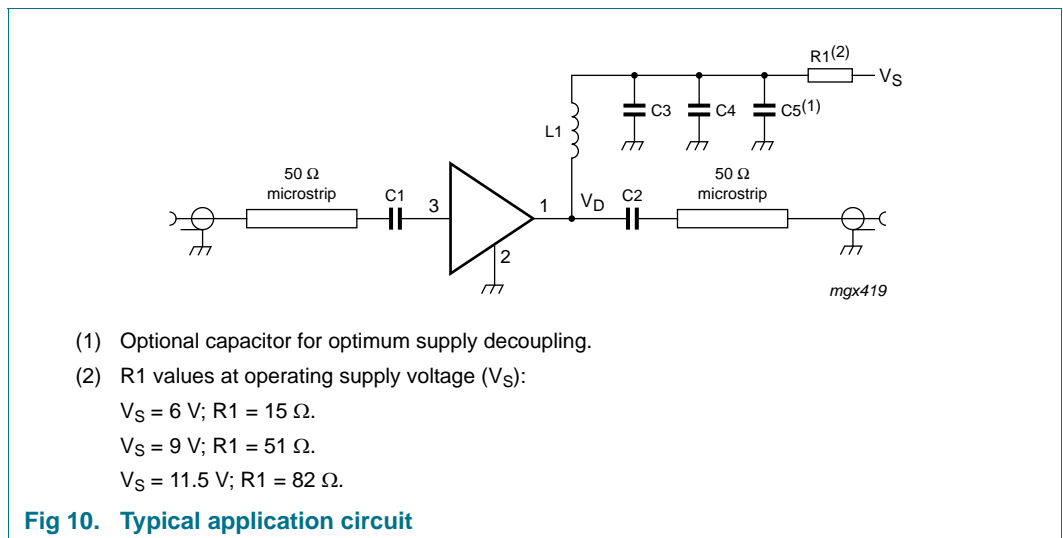

**Table 9. List of components**

See [Figure 10](#) for circuit.

Component	Description	Type	Value at operating frequency				
			500 MHz	800 MHz	1950 MHz	2400 MHz	3500 MHz
C1, C2	multilayer ceramic chip capacitor	0603	220 pF	100 pF	68 pF	56 pF	39 pF
C3	multilayer ceramic chip capacitor	0603	100 pF	68 pF	22 pF	22 pF	15 pF
C4	multilayer ceramic chip capacitor	0603	1 nF	1 nF	1 nF	1 nF	1 nF
C5 <sup>[1]</sup>	electrolytic or tantalum capacitor	0603	1 μF	1 μF	1 μF	1 μF	1 μF
L1	SMD inductor	0603	68 nH	33 nH	22 nH	18 nH	15 nH
R1	SMD resistor, 0.5 W; V <sub>S</sub> = 9 V	-	51 Ω	51 Ω	51 Ω	51 Ω	51 Ω

[1] Optional.

**Table 10. Scattering parameters**

I<sub>S</sub> = 81 mA; V<sub>S</sub> = 9 V; P<sub>D</sub> = -30 dBm; Z<sub>O</sub> = 50 Ω; T<sub>amb</sub> = 25 °C.

f (MHz)	S <sub>11</sub>		S <sub>21</sub>		S <sub>12</sub>		S <sub>22</sub>		K factor
	Magnitude (ratio)	Angle (degree)	Magnitude (ratio)	Angle (degree)	Magnitude (ratio)	Angle (degree)	Magnitude (ratio)	Angle (degree)	
200	0.30	-6.87	16.61	161.86	0.04	2.38	0.34	-20.03	1.0
300	0.31	-10.91	16.18	153.02	0.04	3.66	0.34	-30.50	1.0
400	0.32	-15.72	15.59	144.39	0.04	5.17	0.34	-40.74	1.1
500	0.33	-21.0	14.91	136.01	0.04	6.75	0.34	-50.56	1.1
600	0.33	-26.44	14.19	128.12	0.04	8.67	0.34	-60.07	1.1
700	0.34	-32.08	13.51	120.88	0.04	10.94	0.33	-69.21	1.1
800	0.34	-37.75	12.77	114.19	0.04	13.65	0.33	-77.91	1.1
900	0.35	-43.18	11.88	107.40	0.04	15.15	0.32	-86.13	1.1
1000	0.35	-48.9	11.22	101.34	0.04	17.89	0.32	-94.01	1.1
1100	0.35	-54.2	10.64	95.86	0.04	19.93	0.31	-101.7	1.1
1200	0.35	-59.55	10.0	90.82	0.05	22.11	0.30	-109.1	1.1
1300	0.34	-64.78	9.39	85.46	0.05	24.10	0.30	-116.4	1.1
1400	0.34	-69.93	8.93	80.15	0.05	24.62	0.29	-123.6	1.1
1500	0.33	-74.81	8.54	75.95	0.05	25.98	0.28	-130.9	1.1
1600	0.33	-79.82	8.07	72.26	0.05	27.67	0.27	-138.2	1.1
1700	0.32	-84.88	7.60	67.95	0.06	28.69	0.26	-145.7	1.1
1800	0.31	-89.81	7.32	63.43	0.06	28.33	0.25	-153.6	1.1
1900	0.30	-94.89	7.08	59.81	0.06	28.44	0.24	-162.0	1.1
2000	0.29	-100.3	6.74	56.09	0.07	29.27	0.23	-170.7	1.1
2100	0.28	-105.9	6.46	51.84	0.07	29.17	0.23	179.99	1.1
2200	0.26	-111.8	6.28	48.02	0.07	28.46	0.22	170.17	1.2
2300	0.25	-118.0	6.07	45.0	0.08	28.37	0.22	160.16	1.2
2400	0.24	-125.2	5.78	41.33	0.08	28.17	0.22	149.59	1.1



**Table 10. Scattering parameters ...continued** $I_S = 81 \text{ mA}$ ;  $V_S = 9 \text{ V}$ ;  $P_D = -30 \text{ dBm}$ ;  $Z_O = 50 \Omega$ ;  $T_{amb} = 25 \text{ }^\circ\text{C}$ .

f (MHz)	S <sub>11</sub>		S <sub>21</sub>		S <sub>12</sub>		S <sub>22</sub>		K factor
	Magnitude (ratio)	Angle (degree)	Magnitude (ratio)	Angle (degree)	Magnitude (ratio)	Angle (degree)	Magnitude (ratio)	Angle (degree)	
2500	0.22	-132.8	5.61	36.72	0.08	26.46	0.23	139.39	1.2
2600	0.21	-141.3	5.51	33.15	0.09	24.85	0.24	129.67	1.0
2700	0.21	-153.3	5.33	30.04	0.09	24.72	0.28	120.55	1.2
2800	0.07	-127.7	6.44	28.98	0.12	24.46	0.28	80.88	1.2
2900	0.19	-167.20	4.88	19.14	0.10	20.48	0.27	105.15	1.2
3000	0.18	178.11	4.78	16.89	0.10	19.71	0.30	96.35	1.2
3100	0.18	165.13	4.57	16.56	0.11	18.98	0.32	89.48	1.0

9. Package outline

Plastic surface-mounted package; exposed die pad for good heat transfer; 3 leads

SOT89

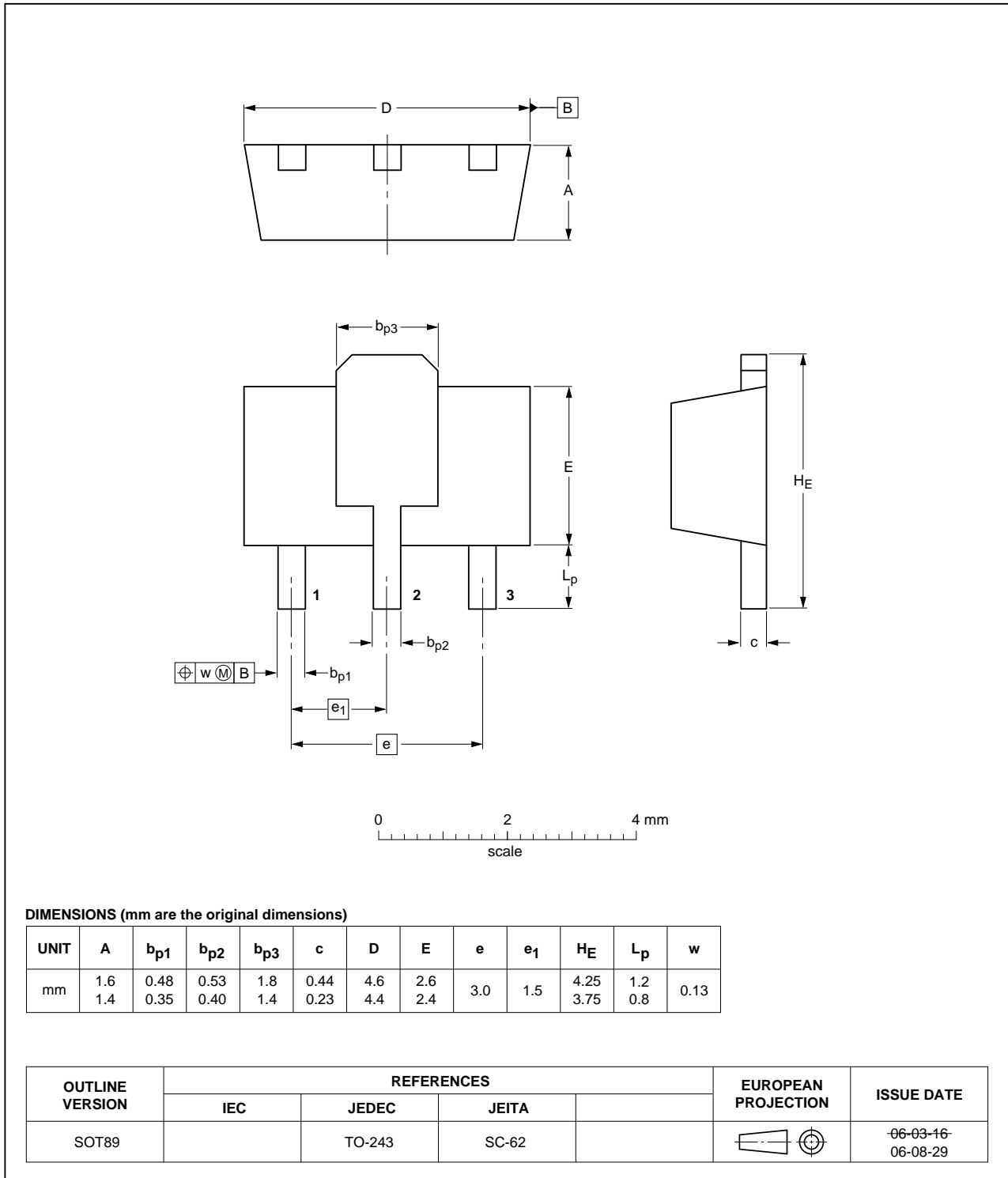

Fig 11. Package outline SOT89 (SC-62)

## 10. Abbreviations

Table 11. Abbreviations

Acronym	Description
CDPD	Cellular Digital Packet Data
IF	Intermediate Frequency
PCS	Power Center Substation
SMD	Surface-Mounted Device
SONET	Synchronous Optical NETwork

## 11. Revision history

Table 12. Revision history

Document ID	Release date	Data sheet status	Change notice	Supersedes
BGA6589 v.3	20111128	Product data sheet	-	BGA6589 v.2
Modifications:				
BGA6589 v.2	20090525	Product data sheet	-	BGA6589 v.1
BGA6589 v.1	20030919	Product specification	-	-

## 12. Legal information

### 12.1 Data sheet status

Document status <sup>[1][2]</sup>	Product status <sup>[3]</sup>	Definition
Objective [short] data sheet	Development	This document contains data from the objective specification for product development.
Preliminary [short] data sheet	Qualification	This document contains data from the preliminary specification.
Product [short] data sheet	Production	This document contains the product specification.

[1] Please consult the most recently issued document before initiating or completing a design.

[2] The term 'short data sheet' is explained in section "Definitions".

[3] The product status of device(s) described in this document may have changed since this document was published and may differ in case of multiple devices. The latest product status information is available on the Internet at URL <http://www.nxp.com>.

### 12.2 Definitions

**Draft** — The document is a draft version only. The content is still under internal review and subject to formal approval, which may result in modifications or additions. NXP Semiconductors does not give any representations or warranties as to the accuracy or completeness of information included herein and shall have no liability for the consequences of use of such information.

**Short data sheet** — A short data sheet is an extract from a full data sheet with the same product type number(s) and title. A short data sheet is intended for quick reference only and should not be relied upon to contain detailed and full information. For detailed and full information see the relevant full data sheet, which is available on request via the local NXP Semiconductors sales office. In case of any inconsistency or conflict with the short data sheet, the full data sheet shall prevail.

**Product specification** — The information and data provided in a Product data sheet shall define the specification of the product as agreed between NXP Semiconductors and its customer, unless NXP Semiconductors and customer have explicitly agreed otherwise in writing. In no event however, shall an agreement be valid in which the NXP Semiconductors product is deemed to offer functions and qualities beyond those described in the Product data sheet.

### 12.3 Disclaimers

**Limited warranty and liability** — Information in this document is believed to be accurate and reliable. However, NXP Semiconductors does not give any representations or warranties, expressed or implied, as to the accuracy or completeness of such information and shall have no liability for the consequences of use of such information.

In no event shall NXP Semiconductors be liable for any indirect, incidental, punitive, special or consequential damages (including - without limitation - lost profits, lost savings, business interruption, costs related to the removal or replacement of any products or rework charges) whether or not such damages are based on tort (including negligence), warranty, breach of contract or any other legal theory.

Notwithstanding any damages that customer might incur for any reason whatsoever, NXP Semiconductors' aggregate and cumulative liability towards customer for the products described herein shall be limited in accordance with the *Terms and conditions of commercial sale* of NXP Semiconductors.

**Right to make changes** — NXP Semiconductors reserves the right to make changes to information published in this document, including without limitation specifications and product descriptions, at any time and without notice. This document supersedes and replaces all information supplied prior to the publication hereof.

**Suitability for use** — NXP Semiconductors products are not designed, authorized or warranted to be suitable for use in life support, life-critical or safety-critical systems or equipment, nor in applications where failure or

malfunction of an NXP Semiconductors product can reasonably be expected to result in personal injury, death or severe property or environmental damage. NXP Semiconductors accepts no liability for inclusion and/or use of NXP Semiconductors products in such equipment or applications and therefore such inclusion and/or use is at the customer's own risk.

**Applications** — Applications that are described herein for any of these products are for illustrative purposes only. NXP Semiconductors makes no representation or warranty that such applications will be suitable for the specified use without further testing or modification.

Customers are responsible for the design and operation of their applications and products using NXP Semiconductors products, and NXP Semiconductors accepts no liability for any assistance with applications or customer product design. It is customer's sole responsibility to determine whether the NXP Semiconductors product is suitable and fit for the customer's applications and products planned, as well as for the planned application and use of customer's third party customer(s). Customers should provide appropriate design and operating safeguards to minimize the risks associated with their applications and products.

NXP Semiconductors does not accept any liability related to any default, damage, costs or problem which is based on any weakness or default in the customer's applications or products, or the application or use by customer's third party customer(s). Customer is responsible for doing all necessary testing for the customer's applications and products using NXP Semiconductors products in order to avoid a default of the applications and the products or of the application or use by customer's third party customer(s). NXP does not accept any liability in this respect.

**Limiting values** — Stress above one or more limiting values (as defined in the Absolute Maximum Ratings System of IEC 60134) will cause permanent damage to the device. Limiting values are stress ratings only and (proper) operation of the device at these or any other conditions above those given in the Recommended operating conditions section (if present) or the Characteristics sections of this document is not warranted. Constant or repeated exposure to limiting values will permanently and irreversibly affect the quality and reliability of the device.

**Terms and conditions of commercial sale** — NXP Semiconductors products are sold subject to the general terms and conditions of commercial sale, as published at <http://www.nxp.com/profile/terms>, unless otherwise agreed in a valid written individual agreement. In case an individual agreement is concluded only the terms and conditions of the respective agreement shall apply. NXP Semiconductors hereby expressly objects to applying the customer's general terms and conditions with regard to the purchase of NXP Semiconductors products by customer.

**No offer to sell or license** — Nothing in this document may be interpreted or construed as an offer to sell products that is open for acceptance or the grant, conveyance or implication of any license under any copyrights, patents or other industrial or intellectual property rights.

**Export control** — This document as well as the item(s) described herein may be subject to export control regulations. Export might require a prior authorization from competent authorities.

**Non-automotive qualified products** — Unless this data sheet expressly states that this specific NXP Semiconductors product is automotive qualified, the product is not suitable for automotive use. It is neither qualified nor tested in accordance with automotive testing or application requirements. NXP Semiconductors accepts no liability for inclusion and/or use of non-automotive qualified products in automotive equipment or applications.

In the event that customer uses the product for design-in and use in automotive applications to automotive specifications and standards, customer (a) shall use the product without NXP Semiconductors' warranty of the product for such automotive applications, use and specifications, and (b) whenever customer uses the product for automotive applications beyond NXP Semiconductors' specifications such use shall be solely at customer's own risk, and (c) customer fully indemnifies NXP Semiconductors for any

liability, damages or failed product claims resulting from customer design and use of the product for automotive applications beyond NXP Semiconductors' standard warranty and NXP Semiconductors' product specifications.

**Quick reference data** — The Quick reference data is an extract of the product data given in the Limiting values and Characteristics sections of this document, and as such is not complete, exhaustive or legally binding.

## 12.4 Trademarks

Notice: All referenced brands, product names, service names and trademarks are the property of their respective owners.

## 13. Contact information

For more information, please visit: <http://www.nxp.com>

For sales office addresses, please send an email to: [salesaddresses@nxp.com](mailto:salesaddresses@nxp.com)

## 14. Contents

<b>1</b>	<b>Product profile</b> . . . . .	<b>1</b>
1.1	General description . . . . .	1
1.2	Features and benefits . . . . .	1
1.3	Applications . . . . .	1
1.4	Quick reference data . . . . .	2
<b>2</b>	<b>Pinning information</b> . . . . .	<b>2</b>
<b>3</b>	<b>Ordering information</b> . . . . .	<b>2</b>
<b>4</b>	<b>Marking</b> . . . . .	<b>2</b>
<b>5</b>	<b>Limiting values</b> . . . . .	<b>3</b>
<b>6</b>	<b>Thermal characteristics</b> . . . . .	<b>3</b>
<b>7</b>	<b>Characteristics</b> . . . . .	<b>3</b>
<b>8</b>	<b>Application information</b> . . . . .	<b>7</b>
<b>9</b>	<b>Package outline</b> . . . . .	<b>10</b>
<b>10</b>	<b>Abbreviations</b> . . . . .	<b>11</b>
<b>11</b>	<b>Revision history</b> . . . . .	<b>11</b>
<b>12</b>	<b>Legal information</b> . . . . .	<b>12</b>
12.1	Data sheet status . . . . .	12
12.2	Definitions . . . . .	12
12.3	Disclaimers . . . . .	12
12.4	Trademarks . . . . .	13
<b>13</b>	<b>Contact information</b> . . . . .	<b>13</b>
<b>14</b>	<b>Contents</b> . . . . .	<b>14</b>

Please be aware that important notices concerning this document and the product(s) described herein, have been included in section 'Legal information'.

© NXP B.V. 2011.

All rights reserved.

For more information, please visit: <http://www.nxp.com>

For sales office addresses, please send an email to: [salesaddresses@nxp.com](mailto:salesaddresses@nxp.com)

Date of release: 28 November 2011

Document identifier: BGA6589

# Mouser Electronics

Authorized Distributor

Click to View Pricing, Inventory, Delivery & Lifecycle Information:

[NXP:](#)

[BGA6589,135](#)