

OptiMOS™3 Power-Transistor

Features

- N-channel, normal level
- Excellent gate charge x $R_{DS(on)}$ product (FOM)
- Very low on-resistance $R_{DS(on)}$
- 175 °C operating temperature
- Pb-free lead plating; RoHS compliant
- Qualified according to JEDEC¹⁾ for target application
- Halogen-free according to IEC61249-2-21
- Ideal for high-frequency switching and synchronous rectification

Product Summary

V_{DS}	200	V
$R_{DS(on),max}$ (TO263)	10.7	mΩ
I_D	88	A



Type	IPB107N20N3 G	IPP110N20N3 G	IPI110N20N3 G
Package	PG-TO263-3	PG-TO220-3	PG-TO262-3
Marking	107N20N	110N20N	110N20N

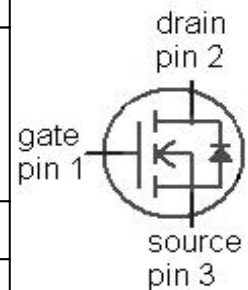

Maximum ratings, at $T_j=25\text{ °C}$, unless otherwise specified

Parameter	Symbol	Conditions	Value	Unit
Continuous drain current	I_D	$T_C=25\text{ °C}$	88	A
		$T_C=100\text{ °C}$	63	
Pulsed drain current ²⁾	$I_{D,pulse}$	$T_C=25\text{ °C}$	352	
Avalanche energy, single pulse	E_{AS}	$I_D=80\text{ A}$, $R_{GS}=25\text{ Ω}$	560	mJ
Reverse diode dv/dt	dv/dt		10	kV/μs
Gate source voltage	V_{GS}		±20	V
Power dissipation	P_{tot}	$T_C=25\text{ °C}$	300	W
Operating and storage temperature	T_j, T_{stg}		-55 ... 175	°C
IEC climatic category; DIN IEC 68-1			55/175/56	

¹⁾J-STD20 and JESD22

²⁾ See figure 3

Parameter	Symbol	Conditions	Values			Unit
			min.	typ.	max.	

Thermal characteristics

Thermal resistance, junction - case	R_{thJC}		-	-	0.5	K/W
Thermal resistance, junction - ambient	R_{thJA}	minimal footprint	-	-	62	
		6 cm ² cooling area ³⁾	-	-	40	

Electrical characteristics, at $T_j=25\text{ °C}$, unless otherwise specified
Static characteristics

Drain-source breakdown voltage	$V_{(BR)DSS}$	$V_{GS}=0\text{ V}, I_D=1\text{ mA}$	200	-	-	V
Gate threshold voltage	$V_{GS(th)}$	$V_{DS}=V_{GS}, I_D=270\text{ }\mu\text{A}$	2	3	4	
Zero gate voltage drain current	I_{DSS}	$V_{DS}=160\text{ V}, V_{GS}=0\text{ V}, T_j=25\text{ °C}$	-	0.1	1	μA
		$V_{DS}=160\text{ V}, V_{GS}=0\text{ V}, T_j=125\text{ °C}$	-	10	100	
Gate-source leakage current	I_{GSS}	$V_{GS}=20\text{ V}, V_{DS}=0\text{ V}$	-	1	100	nA
Drain-source on-state resistance	$R_{DS(on)}$	$V_{GS}=10\text{ V}, I_D=88\text{ A},$ (TO220, TO262)	-	9.9	11	m Ω
		$V_{GS}=10\text{ V}, I_D=88\text{ A},$ (TO263)	-	9.6	10.7	
Gate resistance	R_G		-	2.4	-	Ω
Transconductance	g_{fs}	$ V_{DS} >2 I_D R_{DS(on)max},$ $I_D=88\text{ A}$	71	141	-	S

³⁾ Device on 40 mm x 40 mm x 1.5 mm epoxy PCB FR4 with 6 cm² (one layer, 70 μm thick) copper area for drain connection. PCB is vertical in still air.

Parameter	Symbol	Conditions	Values			Unit
			min.	typ.	max.	

Dynamic characteristics

Input capacitance	C_{iss}	$V_{GS}=0\text{ V}, V_{DS}=100\text{ V}, f=1\text{ MHz}$	-	5340	7100	pF
Output capacitance	C_{oss}		-	401	533	
Reverse transfer capacitance	C_{rss}		-	5	-	
Turn-on delay time	$t_{d(on)}$	$V_{DD}=100\text{ V}, V_{GS}=10\text{ V}, I_D=44\text{ A}, R_G=1.6\ \Omega$	-	18	-	ns
Rise time	t_r		-	26	-	
Turn-off delay time	$t_{d(off)}$		-	41	-	
Fall time	t_f		-	11	-	

Gate Charge Characteristics⁴⁾

Gate to source charge	Q_{gs}	$V_{DD}=100\text{ V}, I_D=44\text{ A}, V_{GS}=0\text{ to }10\text{ V}$	-	23	-	nC
Gate to drain charge	Q_{gd}		-	8	-	
Switching charge	Q_{sw}		-	15	-	
Gate charge total	Q_g		-	65	87	
Gate plateau voltage	$V_{plateau}$		-	4.4	-	
Output charge	Q_{oss}	$V_{DD}=100\text{ V}, V_{GS}=0\text{ V}$	-	162	216	nC

Reverse Diode

Diode continuous forward current	I_S	$T_C=25\text{ }^\circ\text{C}$	-	-	88	A
Diode pulse current	$I_{S,pulse}$		-	-	352	
Diode forward voltage	V_{SD}	$V_{GS}=0\text{ V}, I_F=88\text{ A}, T_j=25\text{ }^\circ\text{C}$	-	1	1.2	V
Reverse recovery time	t_{rr}	$V_R=100\text{ V}, I_F=44\text{ A}, di_F/dt=100\text{ A}/\mu\text{s}$	-	142	-	ns
Reverse recovery charge	Q_{rr}		-	640	-	nC

⁴⁾ See figure 16 for gate charge parameter definition

1 Power dissipation

$$P_{\text{tot}} = f(T_C)$$

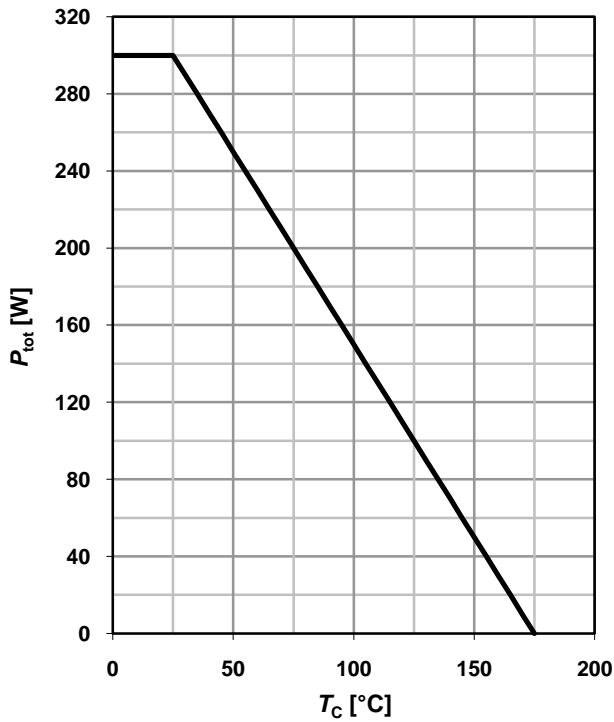

2 Drain current

$$I_D = f(T_C); V_{GS} \geq 10 \text{ V}$$

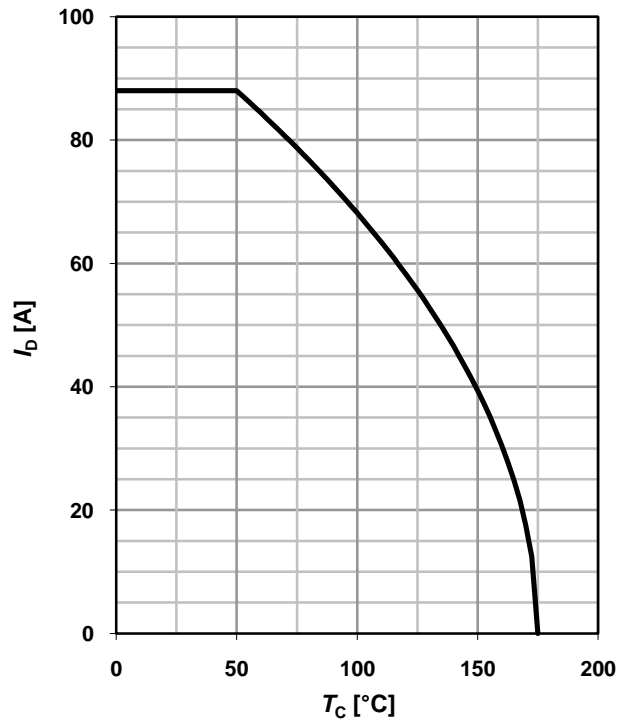

3 Safe operating area

$$I_D = f(V_{DS}); T_C = 25 \text{ °C}; D = 0$$

parameter: t_p

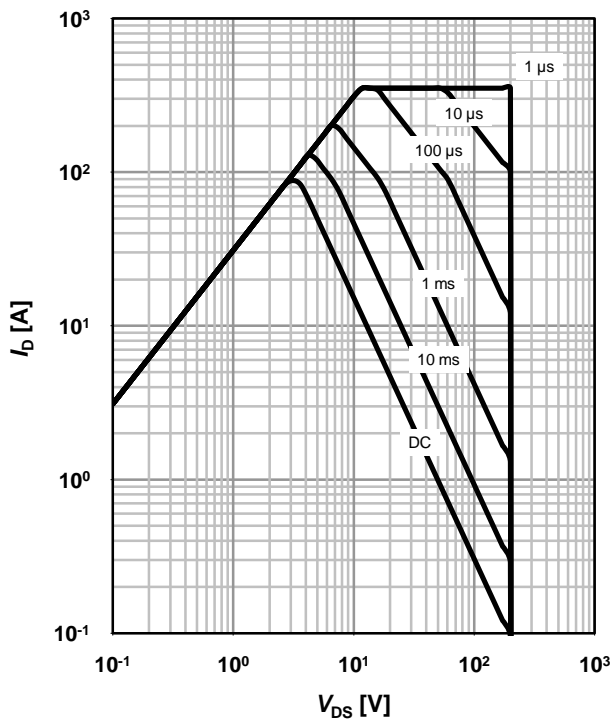

4 Max. transient thermal impedance

$$Z_{\text{thJC}} = f(t_p)$$

parameter: $D = t_p/T$

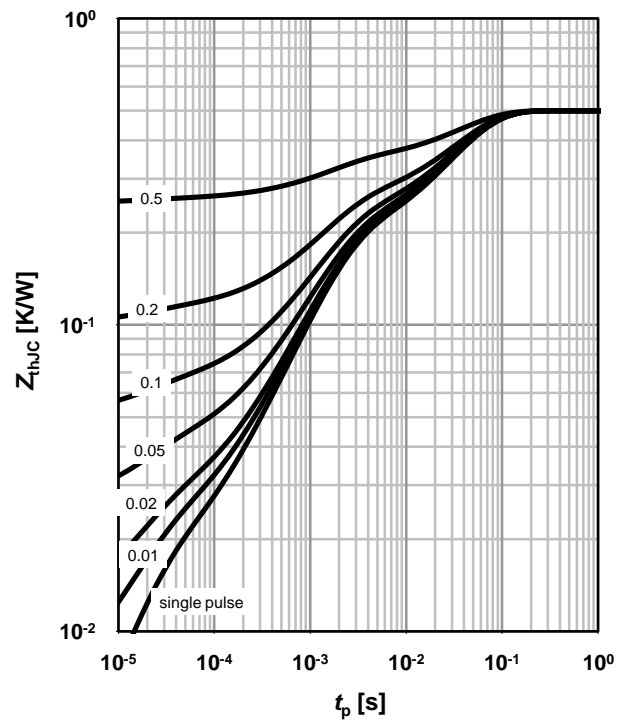

5 Typ. output characteristics

$$I_D = f(V_{DS}); T_j = 25\text{ °C}$$

parameter: V_{GS}

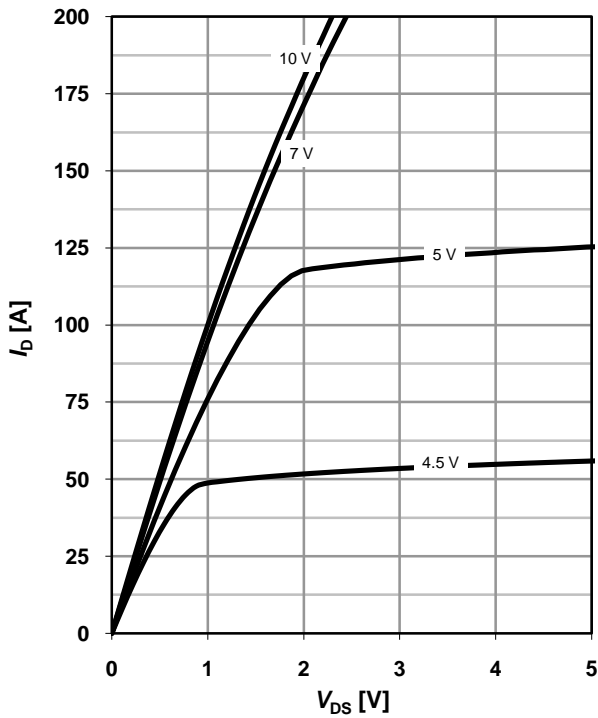

6 Typ. drain-source on resistance

$$R_{DS(on)} = f(I_D); T_j = 25\text{ °C}$$

parameter: V_{GS}

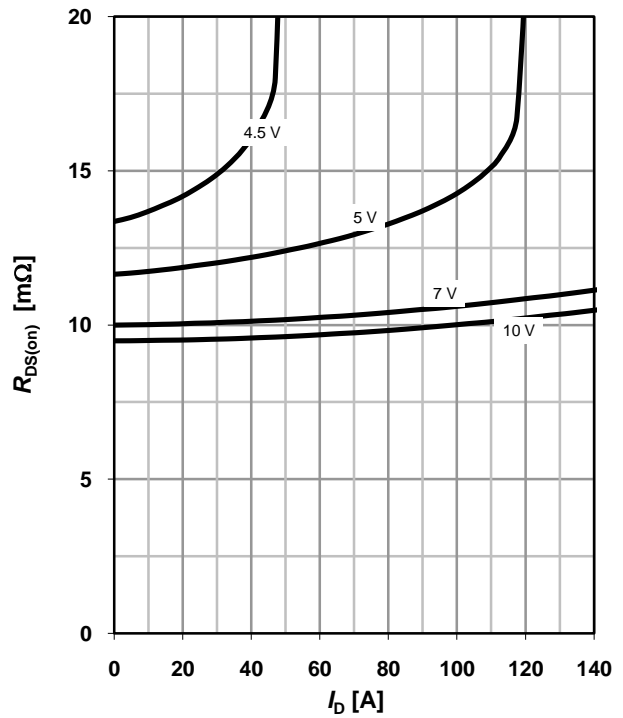

7 Typ. transfer characteristics

$$I_D = f(V_{GS}); |V_{DS}| > 2|I_D|R_{DS(on)max}$$

parameter: T_j

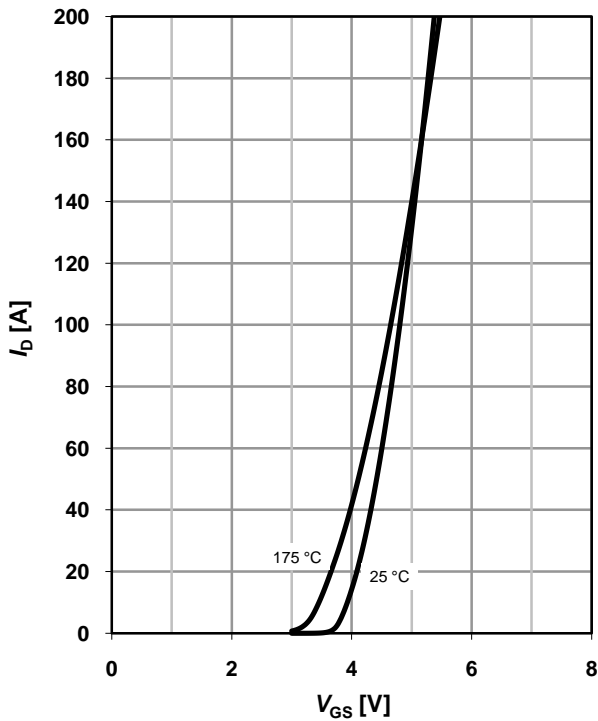

8 Typ. forward transconductance

$$g_{fs} = f(I_D); T_j = 25\text{ °C}$$

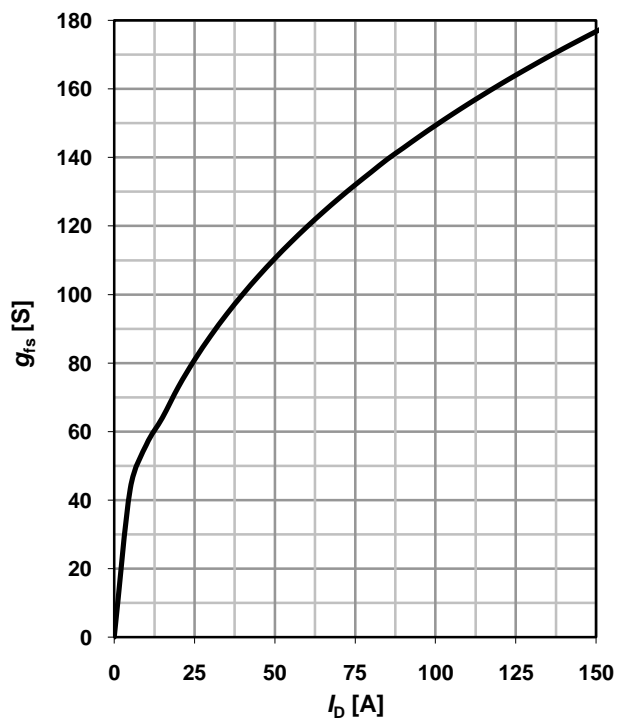

9 Drain-source on-state resistance

$R_{DS(on)}=f(T_j); I_D=88\text{ A}; V_{GS}=10\text{ V}$

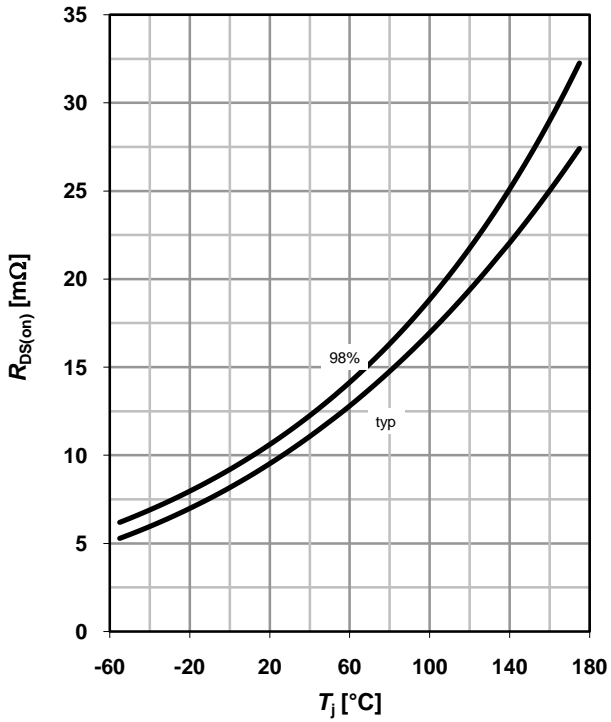

10 Typ. gate threshold voltage

$V_{GS(th)}=f(T_j); V_{GS}=V_{DS}$

parameter: I_D

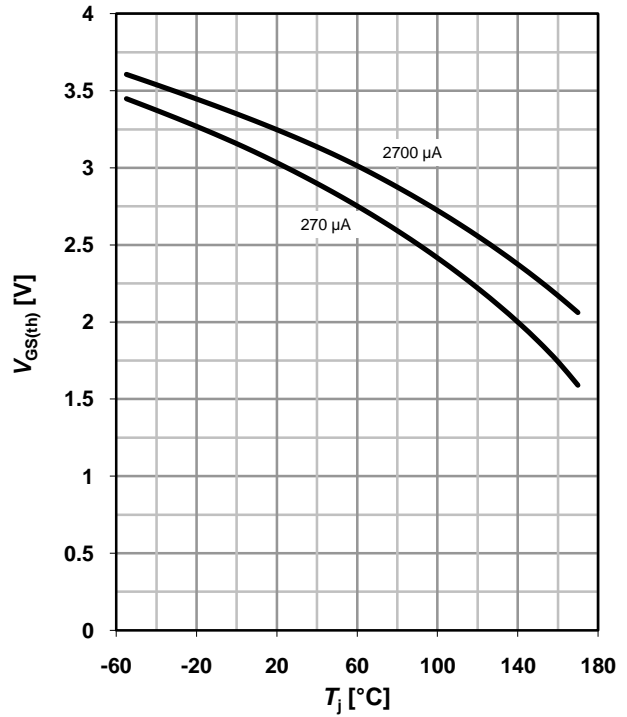

11 Typ. capacitances

$C=f(V_{DS}); V_{GS}=0\text{ V}; f=1\text{ MHz}$

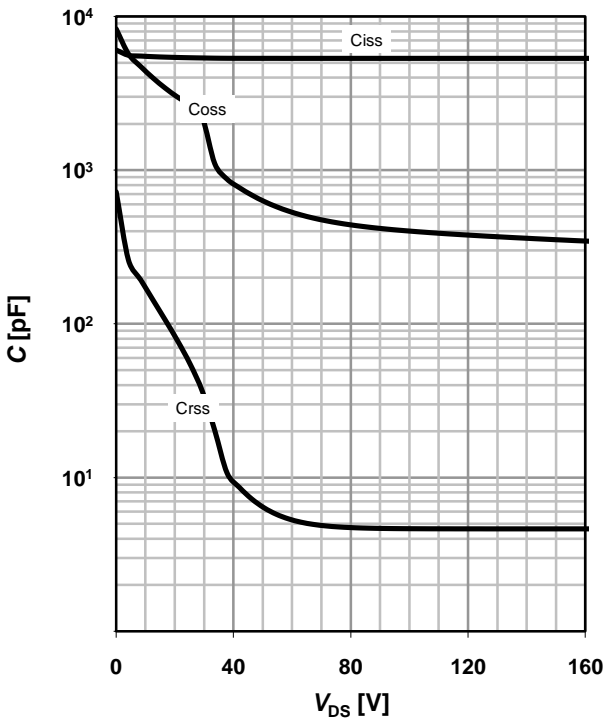

12 Forward characteristics of reverse diode

$I_F=f(V_{SD})$

parameter: T_j

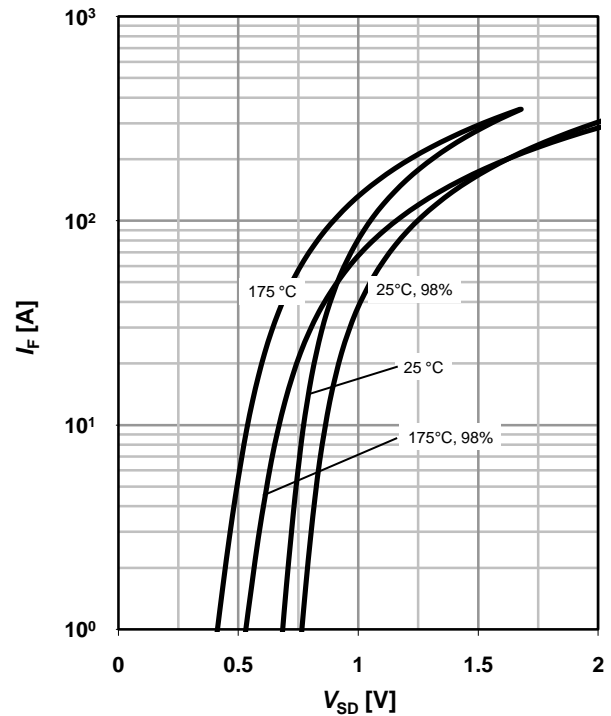

13 Avalanche characteristics

$$I_{AS} = f(t_{AV}); R_{GS} = 25 \Omega$$

parameter: $T_{j(\text{start})}$

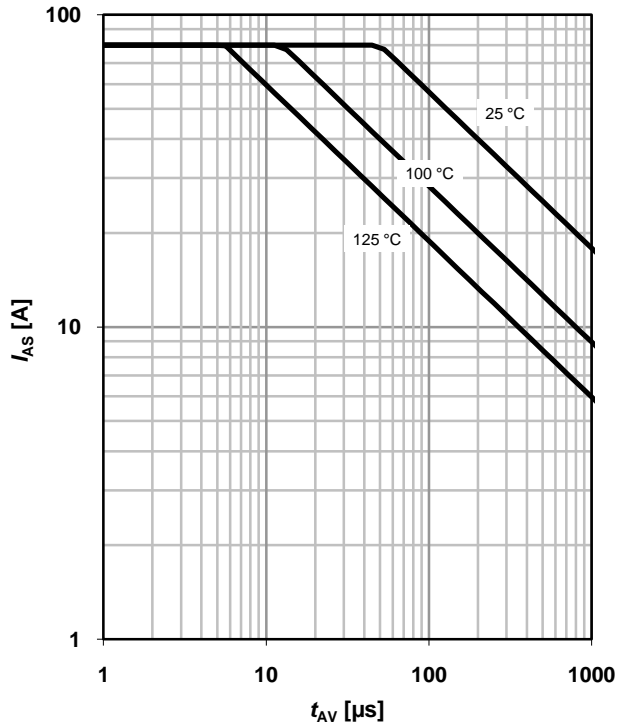

14 Typ. gate charge

$$V_{GS} = f(Q_{\text{gate}}); I_D = 44 \text{ A pulsed}$$

parameter: V_{DD}

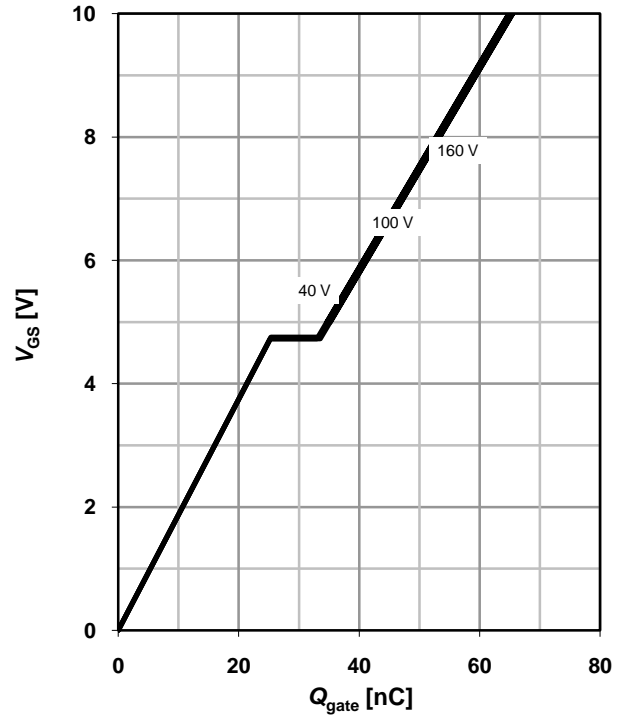

15 Drain-source breakdown voltage

$$V_{BR(DSS)} = f(T_j); I_D = 1 \text{ mA}$$

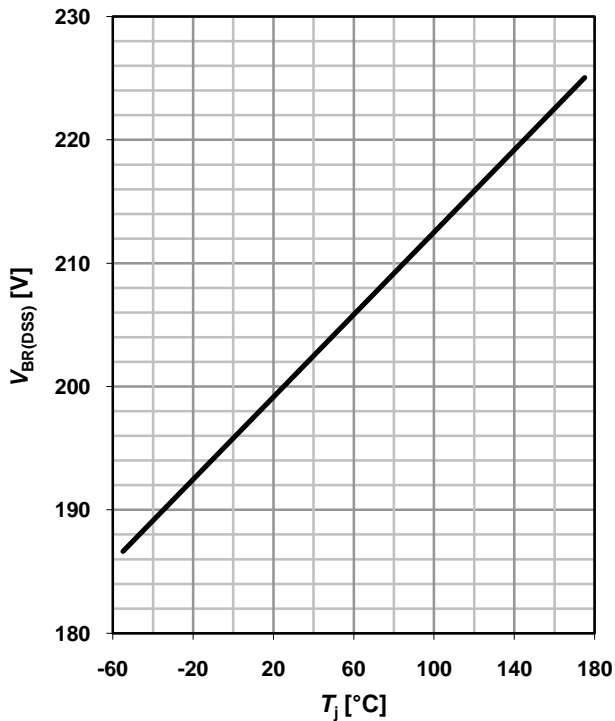

16 Gate charge waveforms

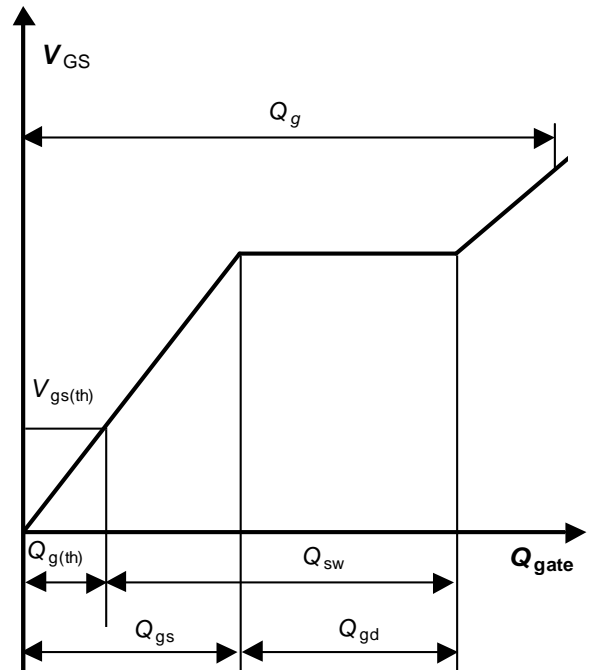

PG-TO220-3: Outline

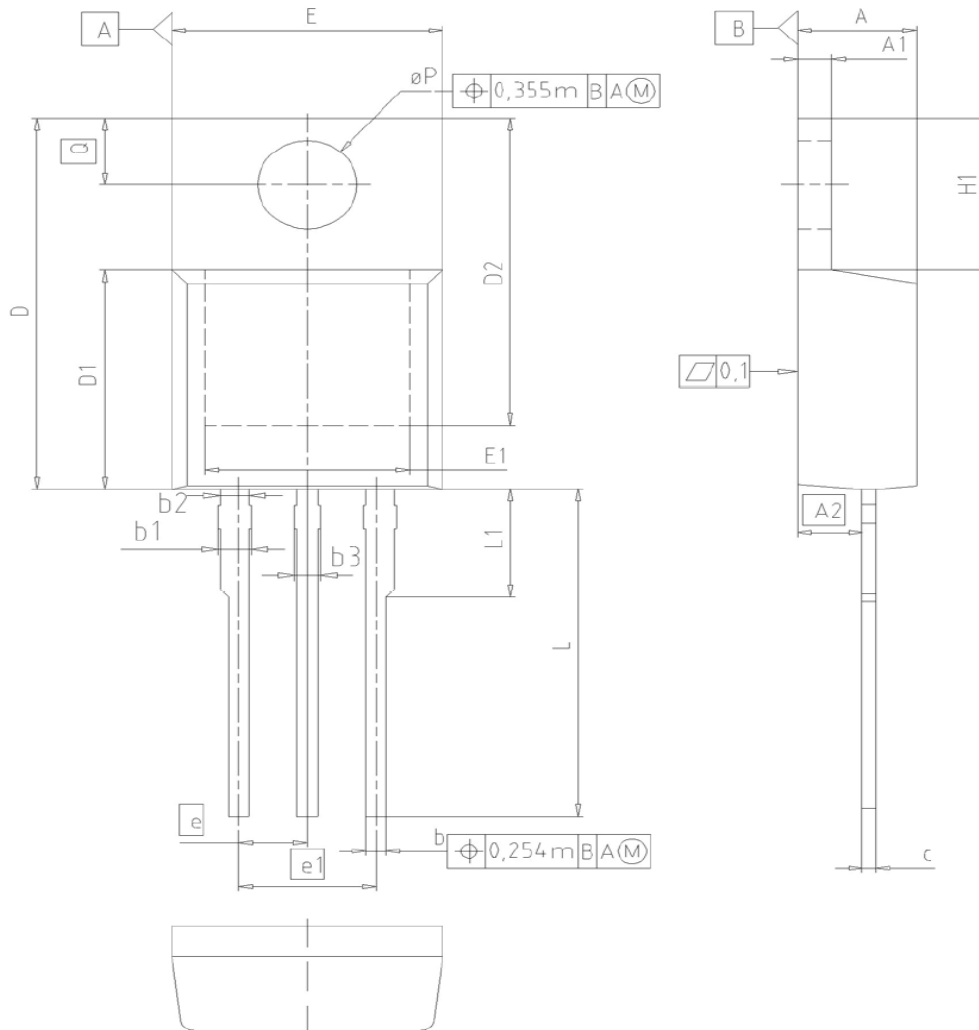

DIM	MILLIMETERS		INCHES	
	MIN	MAX	MIN	MAX
A	4.30	4.57	0.169	0.180
A1	1.17	1.40	0.046	0.055
A2	2.15	2.72	0.085	0.107
b	0.65	0.86	0.026	0.034
b1	0.95	1.40	0.037	0.055
b2	0.95	1.15	0.037	0.045
b3	0.65	1.15	0.026	0.045
c	0.33	0.60	0.013	0.024
D	14.81	15.95	0.583	0.628
D1	8.51	9.45	0.335	0.372
D2	12.19	13.10	0.480	0.516
E	9.70	10.36	0.382	0.408
E1	6.50	8.60	0.256	0.339
e	2.54		0.100	
e1	5.08		0.200	
N	3		3	
H1	5.90	6.90	0.232	0.272
L	13.00	14.00	0.512	0.551
L1	-	4.80	-	0.189
ϕP	3.60	3.89	0.142	0.153
Q	2.60	3.00	0.102	0.118

DOCUMENT NO.
Z8B00003318

SCALE

EUROPEAN PROJECTION

ISSUE DATE
23-08-2007

REVISION
05

PG-TO263-3: Outline

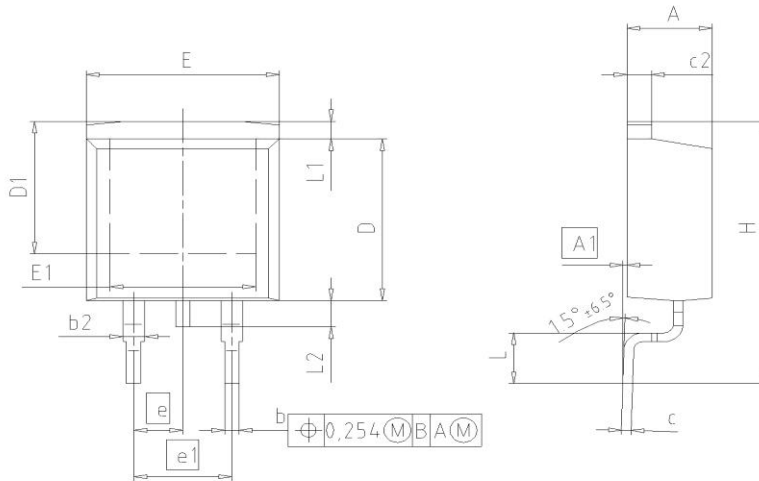

FOOTPRINT

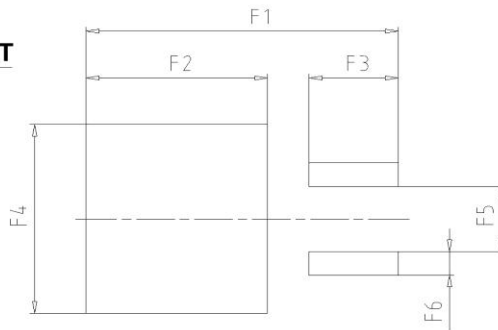

DIM	MILLIMETERS		INCHES	
	MIN	MAX	MIN	MAX
A	4.30	4.57	0.169	0.180
A1	0.00	0.25	0.000	0.010
b	0.65	0.85	0.026	0.033
b2	0.95	1.15	0.037	0.045
c	0.33	0.65	0.013	0.026
c2	1.17	1.40	0.046	0.055
D	8.51	9.45	0.335	0.372
D1	7.10	7.90	0.280	0.311
E	9.80	10.31	0.386	0.406
E1	6.50	8.60	0.256	0.339
e	2.54		0.100	
e1	5.08		0.200	
N	2		2	
H	14.61	15.88	0.575	0.625
L	2.29	3.00	0.090	0.118
L1	0.70	1.60	0.028	0.063
L2	1.00	1.78	0.039	0.070
F1	16.05	16.25	0.632	0.640
F2	9.30	9.50	0.366	0.374
F3	4.50	4.70	0.177	0.185
F4	10.70	10.90	0.421	0.429
F5	3.65	3.85	0.144	0.152
F6	1.25	1.45	0.049	0.057

DOCUMENT NO.
Z8B00003324

SCALE

EUROPEAN PROJECTION

ISSUE DATE
30-08-2007

REVISION
01

PG-TO262-3: Outline

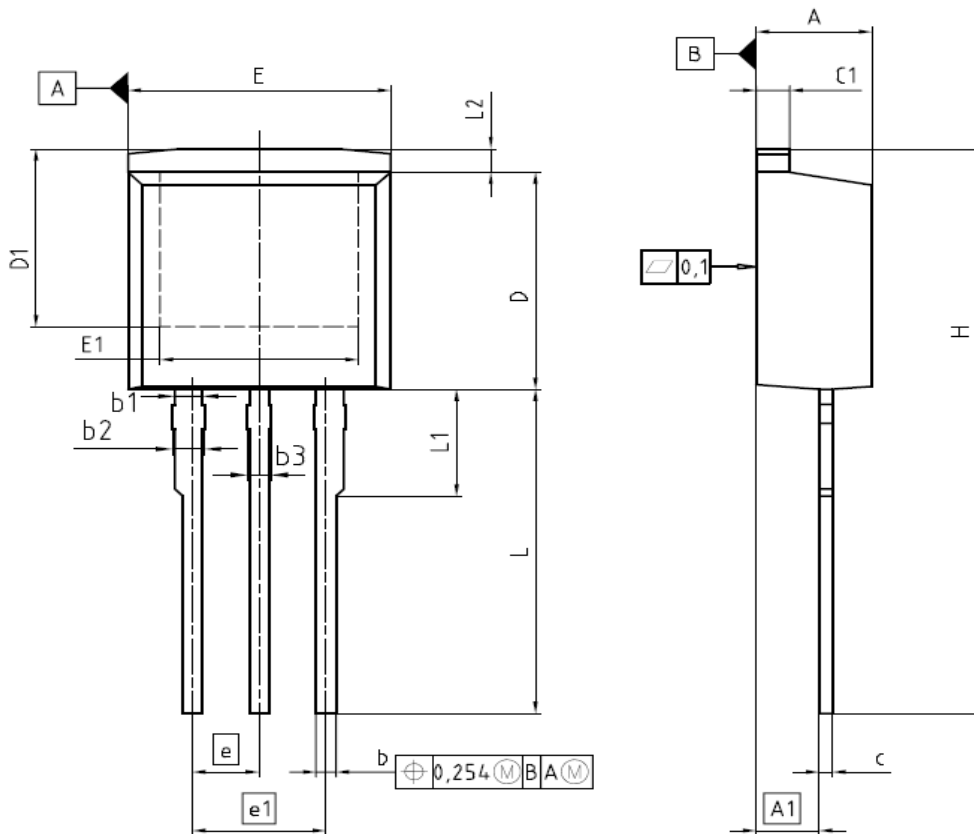

DIM	MILLIMETERS		INCHES	
	MIN	MAX	MIN	MAX
A	4.300	4.572	0.169	0.180
A1	2.150	2.718	0.085	0.107
b	0.650	0.864	0.026	0.034
b1	0.950	1.093	0.037	0.043
b2	0.950	1.400	0.037	0.055
b3	0.650	1.118	0.026	0.044
c	0.330	0.600	0.013	0.024
c1	1.170	1.400	0.046	0.055
D	8.509	9.450	0.335	0.372
D1	6.900	-	0.272	-
E	9.700	10.363	0.382	0.408
E1	6.500	8,600	0,256	0,339
e	2.540		0.100	
e1	5,080		0,200	
N	3		3	
L	13,000	14,000	0,512	0,551
L1	-	4,800	-	0,189
L2	-	1,727	-	0,068

REFERENCE
Z8B00003325

SCALE

EUROPEAN PROJECTION

ISSUE DATE
05-05-2006

REVISION
03

Published by
Infineon Technologies AG
81726 Munich, Germany
© 2009 Infineon Technologies AG
All Rights Reserved.

Legal Disclaimer

The information given in this document shall in no event be regarded as a guarantee of conditions or characteristics. With respect to any examples or hints given herein, any typical values stated herein and/or any information regarding the application of the device, Infineon Technologies hereby disclaims any and all warranties and liabilities of any kind, including without limitation, warranties of non-infringement of intellectual property rights of any third party.

Information

For further information on technology, delivery terms and conditions and prices, please contact the nearest Infineon Technologies Office (www.infineon.com).

on the types in question, please contact the nearest Infineon Technologies Office.
Infineon Technologies components may be used in life-support devices or systems only with the express written approval of Infineon Technologies, if a failure of such components can reasonably be expected to cause the failure of that life-support device or system or to affect the safety or effectiveness of that device or system. Life support devices or systems are intended to be implanted in the human body or to support and/or maintain and sustain and/or protect human life. If they fail, it is reasonable to assume that the health of the user or other persons may be endangered.

Mouser Electronics

Authorized Distributor

Click to View Pricing, Inventory, Delivery & Lifecycle Information:

[Infineon:](#)

[IPP110N20N3 G](#) [IPB107N20N3 G](#) [IP1110N20N3 G](#) [IPB107N20N3GATMA1](#) [IPP110N20N3GXKSA1](#)