

THIS DOCUMENT IS THE PROPERTY OF
KEYSTONE ELECTRONICS CORP. AND
SHALL NOT BE REPRODUCED, DISTRIBUTED
OR USED AS A BASIS FOR MANUFACTURE
WITHOUT PRIOR WRITTEN PERMISSION
FROM KEYSTONE ELECTRONICS CORP.

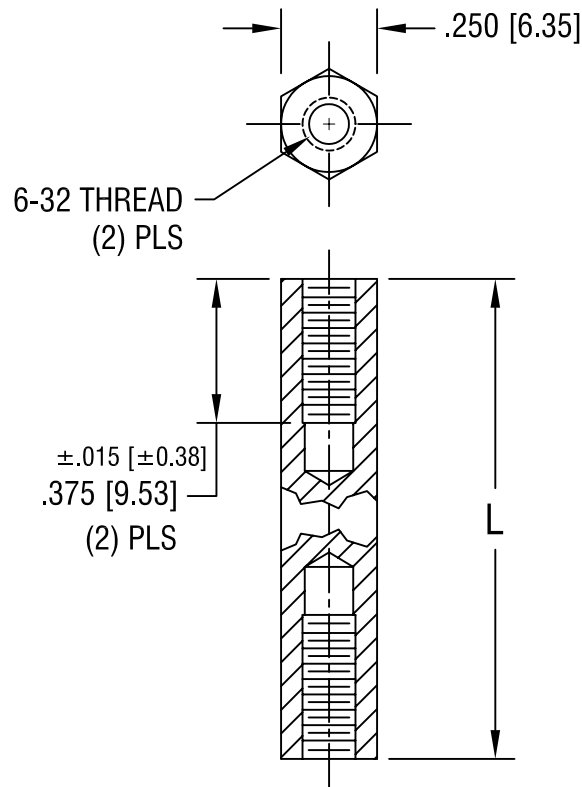

PART NO.	'L' DIM.
1818	1.250 [31.75]
1819	1.750 [44.45]
1820	2.250 [57.15]

KEYSTONE ELECTRONICS CORP.

ASTORIA, N.Y. 11105-2017

PART NAME

THREADED HEX STANDOFF

MATERIAL

ALUMINUM

FINISH

CLEAR IRIDITE

DRN BY

BOONE

DATE

3.9.98

APP'D

LN

SCALE

2X

TOLERANCES

INCH [MM]

DECIMAL ±.005 [± 0.15]

ANGULAR ± 1°
UNLESS OTHERWISE SPECIFIED

CODE

DWG NO.

C/M

1818-1820

DATE

DESCRIPTION

REV.

Mouser Electronics

Authorized Distributor

Click to View Pricing, Inventory, Delivery & Lifecycle Information:

[Keystone Electronics:](#)

[1820](#)