



Low Profile



Isolated



OCP

Safety
Approvals

SUS, SUW-series / SUCS, SUCW-series / SUTS, SUTW-series

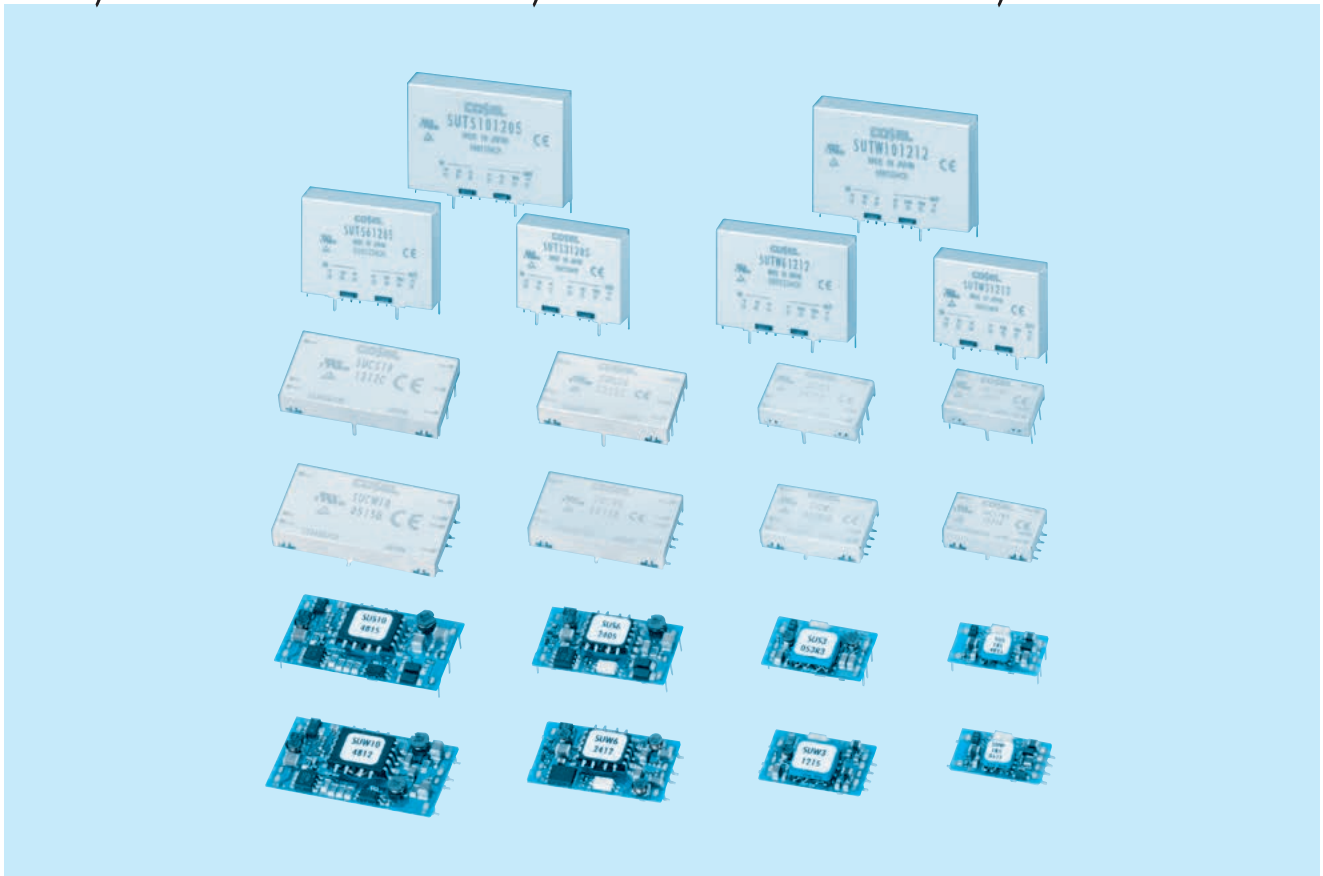

Feature

- SMD mounting type and through-hole mounting type
- High efficiency (synchronous rectifier circuit)
- Built-in overcurrent protection circuits
- Built-in remote ON/OFF (SU / SUC / SUT 3-10)
- High reliability : not built-in aluminum and tantalum electrolytic capacitor

CE marking

- Low Voltage Directive
- RoHS Directive

Safety agency approvals

- UL60950-1, C-UL, EN60950-1

5-year warranty

SUS1R5

SU S 1R5 12 05 B P

① ② ③ ④ ⑤ ⑥ ⑦

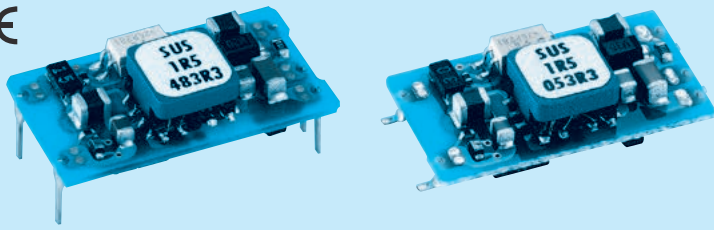
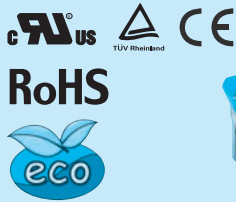

- ① Series name
- ② Single output
- ③ Output wattage
- ④ Input voltage
- ⑤ Output voltage
- ⑥ Mounting type
B : SMD
C : DIP
- ⑦ Packing form
Blank: Plastic cover
P : Tray (SMD type)

MODEL	SUS1R5053R3	SUS1R50505	SUS1R50512	SUS1R50515	SUS1R5123R3	SUS1R51205	SUS1R51212	SUS1R51215	
MAX OUTPUT WATTAGE[W]	1.32	1.5	1.56	1.5	1.32	1.5	1.56	1.5	
DC OUTPUT	VOLTAGE[V] *1	3.3	5	12	15	3.3	5	12	15
	CURRENT[A]	0.4	0.3	0.13	0.1	0.4	0.3	0.13	0.1

SPECIFICATIONS

	MODEL	SUS1R5053R3	SUS1R50505	SUS1R50512	SUS1R50515	SUS1R5123R3	SUS1R51205	SUS1R51212	SUS1R51215	
INPUT	VOLTAGE[V]	DC4.5 - 9				DC9 - 18				
	CURRENT[A] *2	0.377typ	0.405typ	0.422typ	0.405typ	0.153typ	0.164typ	0.171typ	0.164typ	
	EFFICIENCY[%] *2	70typ	74typ	74typ	74typ	72typ	76typ	76typ	76typ	
OUTPUT	VOLTAGE[V]	3.3	5	12	15	3.3	5	12	15	
	CURRENT[A]	0.4	0.3	0.13	0.1	0.4	0.3	0.13	0.1	
	LINE REGULATION[mV]	20max	20max	48max	60max	20max	20max	48max	60max	
	LOAD REGULATION[mV]	40max	40max	100max	120max	40max	40max	100max	120max	
	RIPPLE[mVp-p]	-20 to +55°C *3	80max	80max	120max	120max	80max	80max	120max	120max
		-40 to -20°C *3	120max	120max	150max	150max	120max	120max	150max	150max
	RIPPLE NOISE[mVp-p]	-20 to +55°C *3	120max	120max	150max	150max	120max	120max	150max	150max
		-40 to -20°C *3	200max	200max	200max	200max	200max	200max	200max	200max
	TEMPERATURE REGULATION[mV]	-20 to +55°C	50max	50max	150max	180max	50max	50max	150max	180max
		-40 to +55°C	80max	80max	240max	290max	80max	80max	240max	290max
DRIFT[mV] *4	20max	20max	48max	60max	20max	20max	48max	60max		
START-UP TIME[ms]	20max (Minimum input, Io=100%)									
OUTPUT VOLTAGE ADJUSTMENT RANGE	Fixed (TRM pin open) ±5% adjustable by external VR									
OUTPUT VOLTAGE SETTING[V] (±3%)	3.21 - 3.42	4.90 - 5.21	11.64 - 12.36	14.55 - 15.45	3.21 - 3.42	4.90 - 5.21	11.64 - 12.36	14.55 - 15.45		
OVERCURRENT PROTECTION	Works over 105% of rating and recovers automatically									

PROTECTION CIRCUIT AND OTHERS

MODEL	SUS1R5243R3	SUS1R52405	SUS1R52412	SUS1R52415	SUS1R5483R3	SUS1R54805	SUS1R54812	SUS1R54815	
MAX OUTPUT WATTAGE[W]	1.32	1.5	1.56	1.5	1.32	1.5	1.56	1.5	
DC OUTPUT	VOLTAGE[V] *1	3.3	5	12	15	3.3	5	12	15
	CURRENT[A]	0.4	0.3	0.13	0.1	0.4	0.3	0.13	0.1

SPECIFICATIONS

	MODEL	SUS1R5243R3	SUS1R52405	SUS1R52412	SUS1R52415	SUS1R5483R3	SUS1R54805	SUS1R54812	SUS1R54815	
INPUT	VOLTAGE[V]	DC18 - 36				DC36 - 76				
	CURRENT[A] *2	0.076typ	0.082typ	0.084typ	0.081typ	0.038typ	0.041typ	0.042typ	0.041typ	
	EFFICIENCY[%] *2	72typ	76typ	77typ	77typ	72typ	76typ	77typ	77typ	
OUTPUT	VOLTAGE[V]	3.3	5	12	15	3.3	5	12	15	
	CURRENT[A]	0.4	0.3	0.13	0.1	0.4	0.3	0.13	0.1	
	LINE REGULATION[mV]	20max	20max	48max	60max	20max	20max	48max	60max	
	LOAD REGULATION[mV]	40max	40max	100max	120max	40max	40max	100max	120max	
	RIPPLE[mVp-p]	-20 to +55°C *3	80max	80max	120max	120max	80max	80max	120max	120max
		-40 to -20°C *3	120max	120max	150max	150max	120max	120max	150max	150max
	RIPPLE NOISE[mVp-p]	-20 to +55°C *3	120max	120max	150max	150max	120max	120max	150max	150max
		-40 to -20°C *3	200max	200max	200max	200max	200max	200max	200max	200max
	TEMPERATURE REGULATION[mV]	-20 to +55°C	50max	50max	150max	180max	50max	50max	150max	180max
		-40 to +55°C	80max	80max	240max	290max	80max	80max	240max	290max
DRIFT[mV] *4	20max	20max	48max	60max	20max	20max	48max	60max		
START-UP TIME[ms]	20max (Minimum input, Io=100%)									
OUTPUT VOLTAGE ADJUSTMENT RANGE	Fixed (TRM pin open) ±5% adjustable by external VR									
OUTPUT VOLTAGE SETTING[V] (±3%)	3.21 - 3.42	4.90 - 5.21	11.64 - 12.36	14.55 - 15.45	3.21 - 3.42	4.90 - 5.21	11.64 - 12.36	14.55 - 15.45		
OVERCURRENT PROTECTION	Works over 105% of rating and recovers automatically									

PROTECTION CIRCUIT AND OTHERS

GENERAL SPECIFICATIONS

ISOLATION	INPUT-OUTPUT	AC500V 1minute, Cutoff current = 10mA, DC500V 50MΩ min (20±15°C)
ENVIRONMENT	OPERATING TEMP.,HUMID.AND ALTITUDE	-40 to +85°C, 20 - 95%RH (Non condensing) (Refer to "Derating"), 3,000m (10,000feet) max
	STORAGE TEMP.,HUMID.AND ALTITUDE	-40 to +100°C, 20 - 95%RH (Non condensing), 9,000m (30,000feet) max
	VIBRATION	10 - 55Hz, 98.0m/s ² (10G), 3minutes period, 60minutes each along X, Y and Z axis
	IMPACT	490.3m/s ² (50G), 11ms, once each along X, Y and Z axis
SAFETY	AGENCY APPROVALS	UL60950-1, C-UL, EN60950-1
OTHERS	CASE SIZE/WEIGHT	21.4 X 6.5 X 12.2mm [0.84 X 0.26 X 0.48 inches] (W X H X D) / 2g max
	COOLING METHOD	Convection/Forced air

- *1 SUW1R5x12/SUW1R5x15 is available as single output, +24V/+30V.
- *2 Rated input 5V, 12V, 24V or 48V DC I_o=100%
- *3 Ripple and Ripple Noise is measured by using measuring board with capacitor with in 25mm from output pin terminals.
- *4 Drift is the change in DC output for an eight hour period after a half-hour warm-up at 25°C.
- * Parallel operation with other model is not possible.

External view

1. SMD(type B)

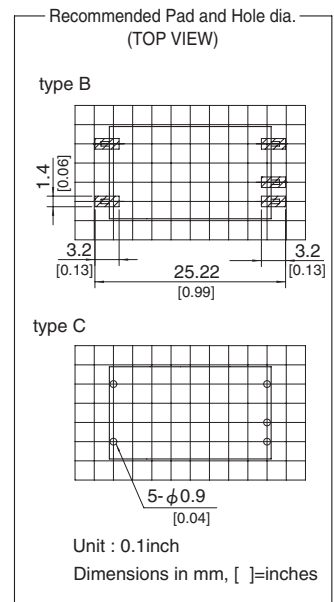
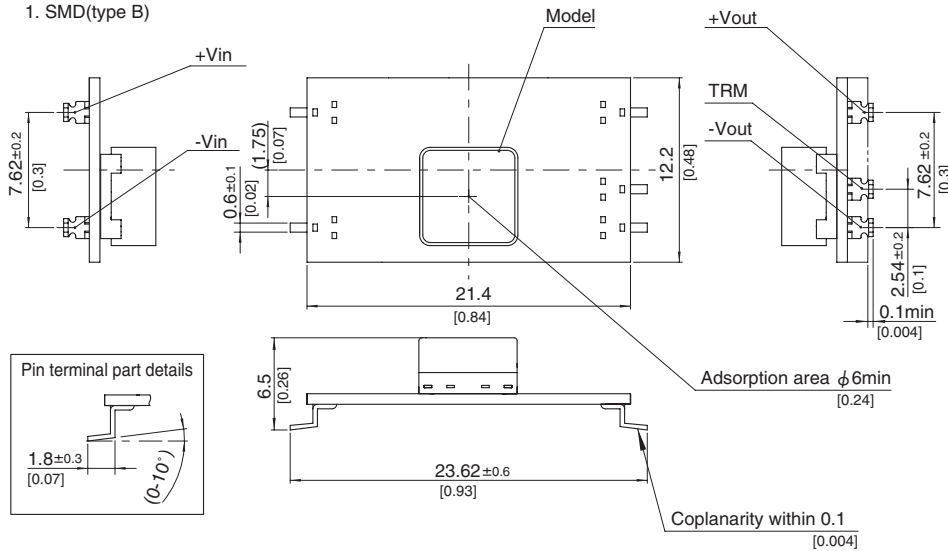

2. DIP(type C)

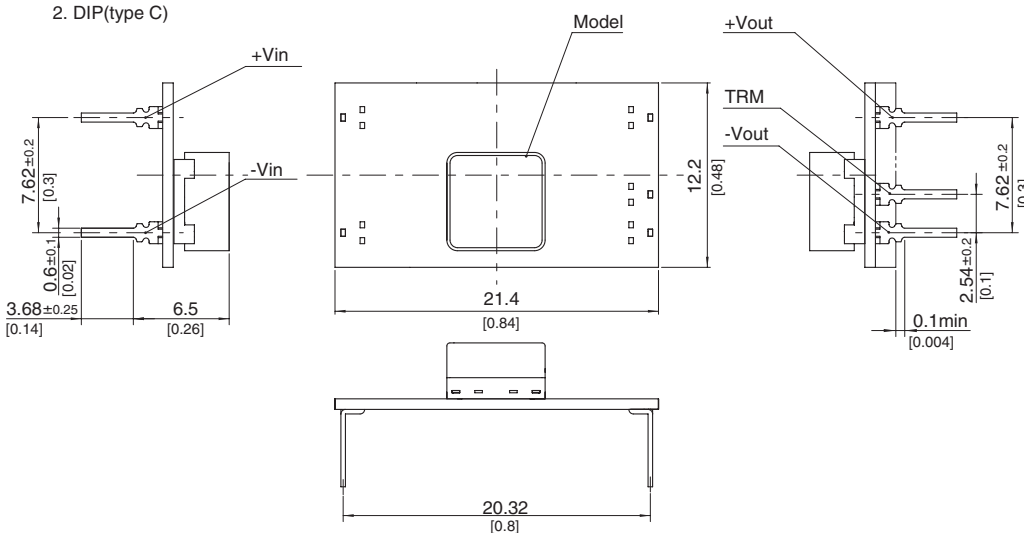

- ※ Tolerance ±0.5 [±0.02]
- ※ Dimensions in mm, []=inches
- ※ Pin terminal thickness : 0.3±0.1 [0.012]
- ※ Pin terminal material : Copper alloy
- ※ Plating treatment of terminal : Lead free plating
- ※ Weight : 2g max

SUW1R5

SU W 1R5 12 12 B P

① ② ③ ④ ⑤ ⑥ ⑦

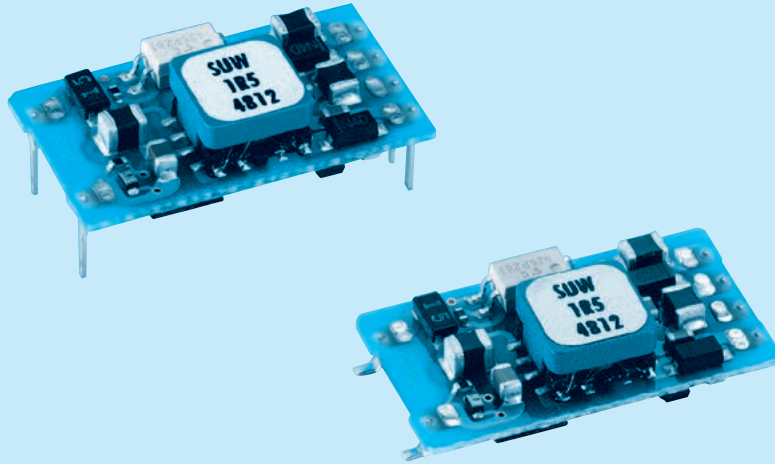

- ① Series name
- ② Dual output
- ③ Output wattage
- ④ Input voltage
- ⑤ Output voltage
- ⑥ Mounting type
B :SMD
C :DIP
- ⑦ Packing form
Blank:Plastic cover
P :Tray (SMD type)

MODEL	SUW1R50512	SUW1R50515	SUW1R51212	SUW1R51215	SUW1R52412	SUW1R52415	SUW1R54812	SUW1R54815	
MAX OUTPUT WATTAGE[W]	1.56	1.5	1.56	1.5	1.56	1.5	1.56	1.5	
DC OUTPUT	VOLTAGE[V] *1	± 12 or +24	± 15 or +30	± 12 or +24	± 15 or +30	± 12 or +24	± 15 or +30	± 12 or +24	± 15 or +30
	CURRENT[A]	0.065	0.05	0.065	0.05	0.065	0.05	0.065	0.05

SPECIFICATIONS

	MODEL	SUW1R50512	SUW1R50515	SUW1R51212	SUW1R51215	SUW1R52412	SUW1R52415	SUW1R54812	SUW1R54815	
INPUT	VOLTAGE[V]	DC4.5 - 9		DC9 - 18		DC18 - 36		DC36 - 76		
	CURRENT[A] *2	0.433typ	0.417typ	0.173typ	0.167typ	0.087typ	0.083typ	0.043typ	0.042typ	
	EFFICIENCY[%] *2	72typ	72typ	75typ	75typ	75typ	75typ	75typ	75typ	
OUTPUT	VOLTAGE[V]	± 12(+24)	± 15(+30)	± 12(+24)	± 15(+30)	± 12(+24)	± 15(+30)	± 12(+24)	± 15(+30)	
	CURRENT[A]	0.065	0.05	0.065	0.05	0.065	0.05	0.065	0.05	
	LINE REGULATION[mV]	60max	75max	60max	75max	60max	75max	60max	75max	
	LOAD REGULATION[mV]	600max	750max	600max	750max	600max	750max	600max	750max	
	RIPPLE[mVp-p]	-20 to +55°C *3	120max	120max	120max	120max	120max	120max	120max	120max
		-40 to -20°C *3	150max	150max	150max	150max	150max	150max	150max	150max
	RIPPLE NOISE[mVp-p]	-20 to +55°C *3	150max	150max	150max	150max	150max	150max	150max	150max
		-40 to -20°C *3	200max	200max	200max	200max	200max	200max	200max	200max
	TEMPERATURE REGULATION[mV]	-20 to +55°C	150max	180max	150max	180max	150max	180max	150max	180max
	-40 to +55°C	240max	290max	240max	290max	240max	290max	240max	290max	
DRIFT[mV] *4	50max	60max	50max	60max	50max	60max	50max	60max		
START-UP TIME[ms]	20max (Minimum input, Io=100%)									
OUTPUT VOLTAGE ADJUSTMENT RANGE	Fixed (TRM pin open) ±5% adjustable by external VR									
OUTPUT VOLTAGE SETTING[V] (±5%)	11.40 - 12.60	14.25 - 15.75	11.40 - 12.60	14.25 - 15.75	11.40 - 12.60	14.25 - 15.75	11.40 - 12.60	14.25 - 15.75		
PROTECTION CIRCUIT AND OTHERS	OVERCURRENT PROTECTION	Works over 105% of rating and recovers automatically								
ISOLATION	INPUT-OUTPUT	AC500V 1minute, Cutoff current = 10mA, DC500V 50MΩ min (20±15°C)								
ENVIRONMENT	OPERATING TEMP.,HUMID.AND ALTITUDE	-40 to +85°C, 20 - 95%RH (Non condensing) (Refer to "Derating"), 3,000m (10,000feet) max								
	STORAGE TEMP.,HUMID.AND ALTITUDE	-40 to +100°C, 20 - 95%RH (Non condensing), 9,000m (30,000feet) max								
	VIBRATION	10 - 55Hz, 98.0m/s ² (10G), 3minutes period, 60minutes each along X, Y and Z axis								
	IMPACT	490.3m/s ² (50G), 11ms, once each along X, Y and Z axis								
SAFETY	AGENCY APPROVALS	UL60950-1, C-UL, EN60950-1								
OTHERS	CASE SIZE/WEIGHT	21.4 × 6.5 × 12.2mm [0.84 × 0.26 × 0.48 inches] (W×H×D) / 2g max								
	COOLING METHOD	Convection/Forced air								

*1 Output pins can be connected in series to make a 24V/30V output.
 *2 Rated input 5V, 12V, 24V or 48V DC Io=100%
 *3 Ripple and Ripple Noise is measured by using measuring board with capacitor with in 25mm from output pin terminals.
 *4 Drift is the change in DC output for an eight hour period after a half-hour warm-up at 25°C.
 * Parallel operation with other model is not possible.

External view

1. SMD(type B)

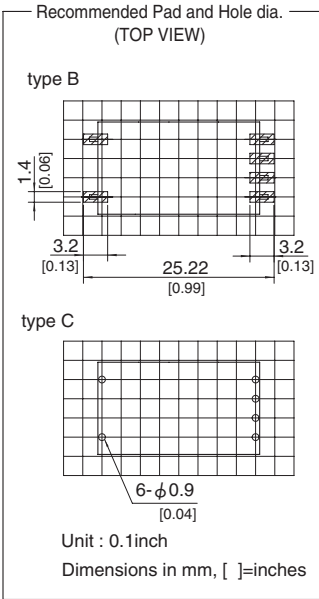
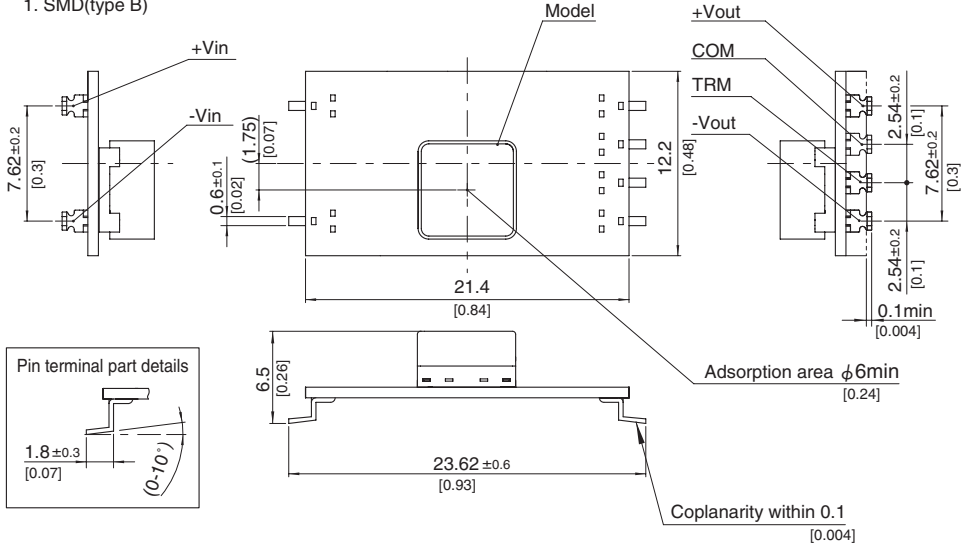

2. DIP(type C)

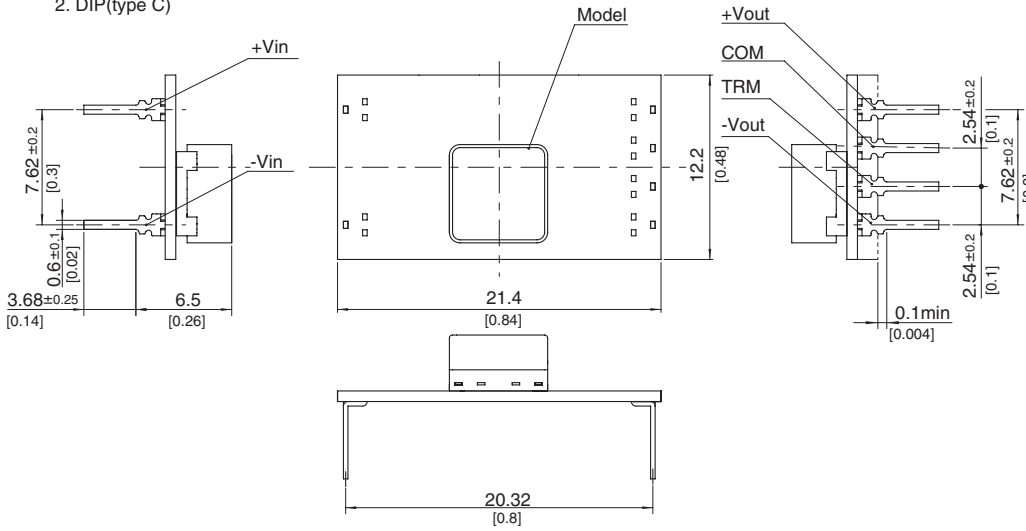

- ※ Tolerance ± 0.5 [± 0.02]
- ※ Dimensions in mm, []=inches
- ※ Pin terminal thickness : 0.3 ± 0.1 [0.012]
- ※ Pin terminal material : Copper alloy
- ※ Plating treatment of terminal : Lead free plating
- ※ Weight : 2g max

SUS3

SU S 3 12 05 B P - □

① ② ③ ④ ⑤ ⑥ ⑦ ⑧

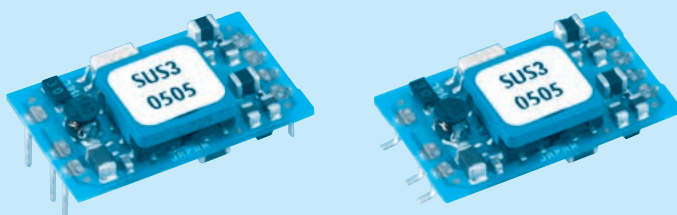
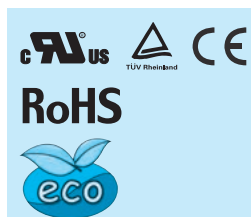

- ① Series name
- ② Single output
- ③ Output wattage
- ④ Input voltage
- ⑤ Output voltage
- ⑥ Mounting type
B : SMD
C : DIP
- ⑦ Packing form
Blank: Plastic cover
P : Tray (SMD type)
- ⑧ Optional
G : Capacitor between Input and Output is removed.

MODEL	SUS3053R3	SUS30505	SUS30512	SUS30515	SUS3123R3	SUS31205	SUS31212	SUS31215
MAX OUTPUT WATTAGE[W]	1.98	3	3	3	1.98	3	3	3
DC OUTPUT	VOLTAGE[V] *1	3.3	5	12	15	3.3	5	12
	CURRENT[A]	0.6	0.6	0.25	0.2	0.6	0.6	0.25

SPECIFICATIONS

	MODEL	SUS3053R3	SUS30505	SUS30512	SUS30515	SUS3123R3	SUS31205	SUS31212	SUS31215	
INPUT	VOLTAGE[V]	DC4.5 - 9				DC9 - 18				
	CURRENT[A] *2	0.536typ	0.780typ	0.760typ	0.760typ	0.218typ	0.317typ	0.309typ	0.313typ	
	EFFICIENCY[%] *2	74typ	77typ	79typ	79typ	76typ	79typ	81typ	80typ	
OUTPUT	VOLTAGE[V]	3.3	5	12	15	3.3	5	12	15	
	CURRENT[A]	0.6	0.6	0.25	0.2	0.6	0.6	0.25	0.2	
	LINE REGULATION[mV]	20max	20max	48max	60max	20max	20max	48max	60max	
	LOAD REGULATION[mV]	40max	40max	100max	120max	40max	40max	100max	120max	
	RIPPLE[mVp-p]	-20 to +55°C *3	80max	80max	120max	120max	80max	80max	120max	120max
		-40 to -20°C *3	120max	120max	150max	150max	120max	120max	150max	150max
	RIPPLE NOISE[mVp-p]	-20 to +55°C *3	120max	120max	150max	150max	120max	120max	150max	150max
		-40 to -20°C *3	200max	200max	200max	200max	200max	200max	200max	200max
	TEMPERATURE REGULATION[mV]	-20 to +55°C	50max	50max	150max	180max	50max	50max	150max	180max
		-40 to +55°C	80max	80max	240max	290max	80max	80max	240max	290max
	DRIFT[mV] *4	20max	20max	48max	60max	20max	20max	48max	60max	
START-UP TIME[ms]	20max (Minimum input, I _o =100%)									
OUTPUT VOLTAGE ADJUSTMENT RANGE	Fixed (TRM pin open) ±5% adjustable by external VR									
OUTPUT VOLTAGE SETTING[V] (±3%)	3.21 - 3.42	4.90 - 5.21	11.64 - 12.36	14.55 - 15.45	3.21 - 3.42	4.90 - 5.21	11.64 - 12.36	14.55 - 15.45		
PROTECTION CIRCUIT AND OTHERS	OVERCURRENT PROTECTION	Works over 105% of rating and recovers automatically								
	REMOTE ON/OFF	Provided (Negative logic L : ON, H : OFF)								

MODEL	SUS3243R3	SUS32405	SUS32412	SUS32415	SUS3483R3	SUS34805	SUS34812	SUS34815
MAX OUTPUT WATTAGE[W]	1.98	3	3	3	1.98	3	3	3
DC OUTPUT	VOLTAGE[V] *1	3.3	5	12	15	3.3	5	12
	CURRENT[A]	0.6	0.6	0.25	0.2	0.6	0.6	0.25

SPECIFICATIONS

	MODEL	SUS3243R3	SUS32405	SUS32412	SUS32415	SUS3483R3	SUS34805	SUS34812	SUS34815	
INPUT	VOLTAGE[V]	DC18 - 36				DC36 - 76				
	CURRENT[A] *2	0.110typ	0.159typ	0.155typ	0.157typ	0.056typ	0.080typ	0.078typ	0.078typ	
	EFFICIENCY[%] *2	75typ	79typ	81typ	80typ	74typ	79typ	81typ	81typ	
OUTPUT	VOLTAGE[V]	3.3	5	12	15	3.3	5	12	15	
	CURRENT[A]	0.6	0.6	0.25	0.2	0.6	0.6	0.25	0.2	
	LINE REGULATION[mV]	20max	20max	48max	60max	20max	20max	48max	60max	
	LOAD REGULATION[mV]	40max	40max	100max	120max	40max	40max	100max	120max	
	RIPPLE[mVp-p]	-20 to +55°C *3	80max	80max	120max	120max	80max	80max	120max	120max
		-40 to -20°C *3	120max	120max	150max	150max	120max	120max	150max	150max
	RIPPLE NOISE[mVp-p]	-20 to +55°C *3	120max	120max	150max	150max	120max	120max	150max	150max
		-40 to -20°C *3	200max	200max	200max	200max	200max	200max	200max	200max
	TEMPERATURE REGULATION[mV]	-20 to +55°C	50max	50max	150max	180max	50max	50max	150max	180max
		-40 to +55°C	80max	80max	240max	290max	80max	80max	240max	290max
	DRIFT[mV] *4	20max	20max	48max	60max	20max	20max	48max	60max	
START-UP TIME[ms]	20max (Minimum input, I _o =100%)									
OUTPUT VOLTAGE ADJUSTMENT RANGE	Fixed (TRM pin open) ±5% adjustable by external VR									
OUTPUT VOLTAGE SETTING[V] (±3%)	3.21 - 3.42	4.90 - 5.21	11.64 - 12.36	14.55 - 15.45	3.21 - 3.42	4.90 - 5.21	11.64 - 12.36	14.55 - 15.45		
PROTECTION CIRCUIT AND OTHERS	OVERCURRENT PROTECTION	Works over 105% of rating and recovers automatically								
	REMOTE ON/OFF	Provided (Negative logic L : ON, H : OFF)								

GENERAL SPECIFICATIONS

ISOLATION	INPUT-OUTPUT	AC500V 1minute, Cutoff current = 10mA, DC500V 50MΩ min (20±15°C)
ENVIRONMENT	OPERATING TEMP., HUMID. AND ALTITUDE	-40 to +85°C, 20 - 95%RH (Non condensing) (Refer to "Derating"), 3,000m (10,000feet) max
	STORAGE TEMP., HUMID. AND ALTITUDE	-40 to +100°C, 20 - 95%RH (Non condensing), 9,000m (30,000feet) max
	VIBRATION	10 - 55Hz, 98.0m/s ² (10G), 3minutes period, 60minutes each along X, Y and Z axis
	IMPACT	490.3m/s ² (50G), 11ms, once each along X, Y and Z axis
SAFETY	AGENCY APPROVALS	UL60950-1, C-UL, EN60950-1
OTHERS	CASE SIZE/WEIGHT	24 X 6.5 X 15.1mm [0.94 X 0.26 X 0.59 inches] (W X H X D) / 3g max
	COOLING METHOD	Convection/Forced air

- *1 SUW3xx12/SUW3xx15 is available as single output, +24V/+30V.
- *2 Rated input 5V, 12V, 24V or 48V DC I_o=100%
- *3 Ripple and Ripple Noise is measured by using measuring board with capacitor with in 25mm from output pin terminals.
- *4 Drift is the change in DC output for an eight hour period after a half-hour warm-up at 25°C.
- * Parallel operation with other model is not possible.

External view

1. SMD (type B)

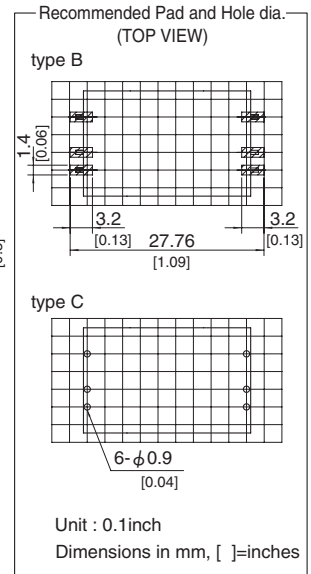
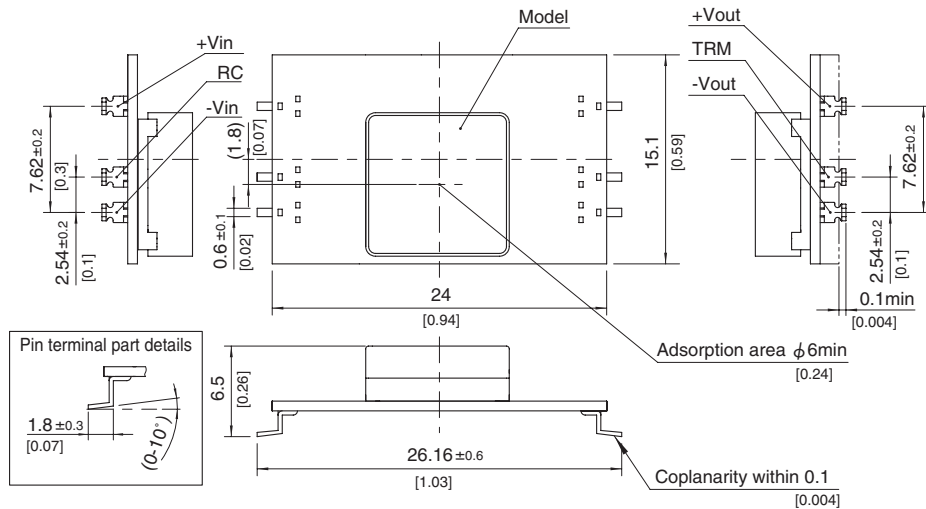

2. DIP (type C)

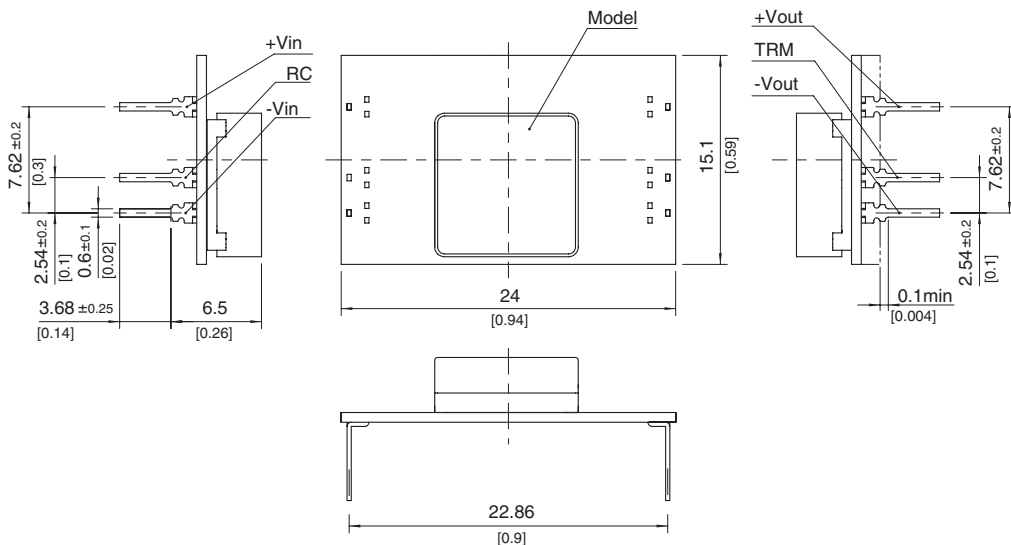

- ※ Tolerance ± 0.5 [± 0.02]
- ※ Dimensions in mm, []=inches
- ※ Pin terminal thickness : 0.3 ± 0.1 [0.012]
- ※ Pin terminal material : Copper alloy
- ※ Plating treatment of terminal : Lead free plating
- ※ Weight : 3g max

SUW3

SU W 3 12 12 B P - □
 ① ② ③ ④ ⑤ ⑥ ⑦ ⑧

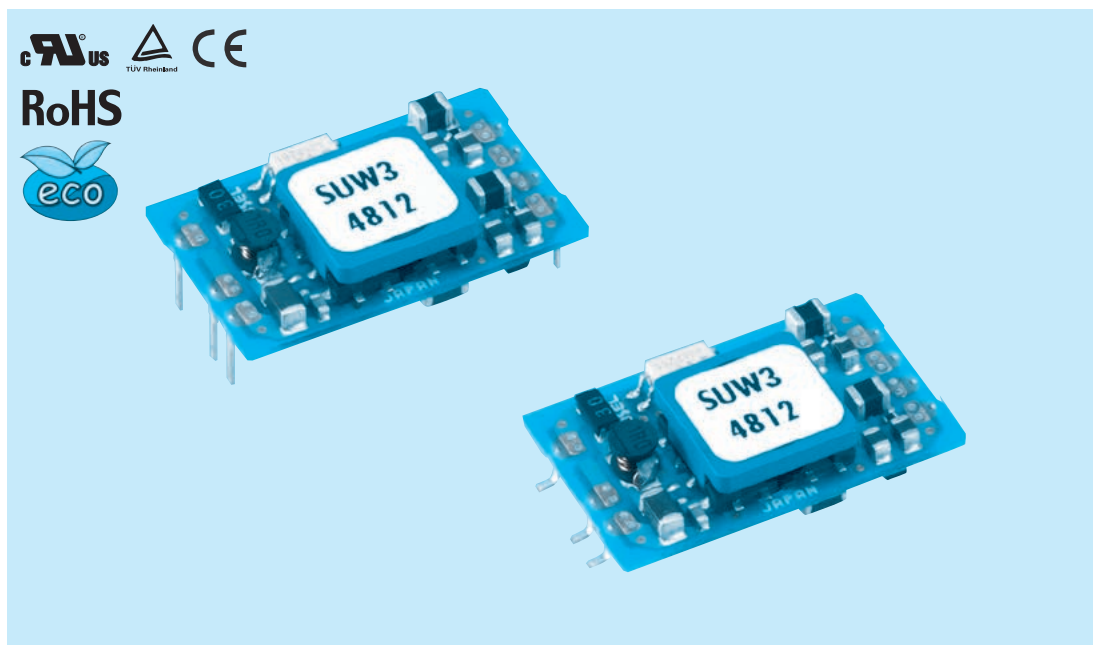

- ① Series name
- ② Dual output
- ③ Output wattage
- ④ Input voltage
- ⑤ Output voltage
- ⑥ Mounting type
B : SMD
C : DIP
- ⑦ Packing form
Blank: Plastic cover
P : Tray (SMD type)
- ⑧ Optional
G : Capacitor between Input and Output is removed.

MODEL	SUW30512	SUW30515	SUW31212	SUW31215	SUW32412	SUW32415	SUW34812	SUW34815	
MAX OUTPUT WATTAGE[W]	3.12	3	3.12	3	3.12	3	3.12	3	
DC OUTPUT	VOLTAGE[V] *1	±12 or +24	±15 or +30	±12 or +24	±15 or +30	±12 or +24	±15 or +30	±12 or +24	±15 or +30
	CURRENT[A]	0.13	0.1	0.13	0.1	0.13	0.1	0.13	0.1

SPECIFICATIONS

	MODEL	SUW30512	SUW30515	SUW31212	SUW31215	SUW32412	SUW32415	SUW34812	SUW34815	
INPUT	VOLTAGE[V]	DC4.5 - 9		DC9 - 18		DC18 - 36		DC36 - 76		
	CURRENT[A] *2	0.822typ	0.790typ	0.334typ	0.321typ	0.167typ	0.161typ	0.084typ	0.081typ	
	EFFICIENCY[%] *2	76typ	76typ	78typ	78typ	78typ	78typ	78typ	78typ	
OUTPUT	VOLTAGE[V]	±12(+24)	±15(+30)	±12(+24)	±15(+30)	±12(+24)	±15(+30)	±12(+24)	±15(+30)	
	CURRENT[A]	0.13	0.1	0.13	0.1	0.13	0.1	0.13	0.1	
	LINE REGULATION[mV]	60max	75max	60max	75max	60max	75max	60max	75max	
	LOAD REGULATION[mV]	600max	750max	600max	750max	600max	750max	600max	750max	
	RIPPLE[mVp-p]	-20 to +55°C *3	120max	120max	120max	120max	120max	120max	120max	120max
		-40 to -20°C *3	150max	150max	150max	150max	150max	150max	150max	150max
	RIPPLE NOISE[mVp-p]	-20 to +55°C *3	150max	150max	150max	150max	150max	150max	150max	150max
		-40 to -20°C *3	200max	200max	200max	200max	200max	200max	200max	200max
	TEMPERATURE REGULATION[mV]	-20 to +55°C	150max	180max	150max	180max	150max	180max	150max	180max
		-40 to +55°C	240max	290max	240max	290max	240max	290max	240max	290max
DRIFT[mV] *4	50max	60max	50max	60max	50max	60max	50max	60max		
START-UP TIME[ms]	20max (Minimum input, Io=100%)									
OUTPUT VOLTAGE ADJUSTMENT RANGE	Fixed (TRM pin open) ±5% adjustable by external VR									
OUTPUT VOLTAGE SETTING[V] (±5%)	11.40 - 12.60	14.25 - 15.75	11.40 - 12.60	14.25 - 15.75	11.40 - 12.60	14.25 - 15.75	11.40 - 12.60	14.25 - 15.75		
PROTECTION CIRCUIT AND OTHERS	OVERCURRENT PROTECTION	Works over 105% of rating and recovers automatically								
	REMOTE ON/OFF	Provided (Negative logic L : ON, H : OFF)								
ISOLATION	INPUT-OUTPUT	AC500V 1minute, Cutoff current = 10mA, DC500V 50MΩ min (20±15°C)								
ENVIRONMENT	OPERATING TEMP., HUMID. AND ALTITUDE	-40 to +85°C, 20 - 95%RH (Non condensing) (Refer to "Derating"), 3,000m (10,000feet) max								
	STORAGE TEMP., HUMID. AND ALTITUDE	-40 to +100°C, 20 - 95%RH (Non condensing), 9,000m (30,000feet) max								
	VIBRATION	10 - 55Hz, 98.0m/s ² (10G), 3minutes period, 60minutes each along X, Y and Z axis								
	IMPACT	490.3m/s ² (50G), 11ms, once each along X, Y and Z axis								
SAFETY	AGENCY APPROVALS	UL60950-1, C-UL, EN60950-1								
OTHERS	CASE SIZE/WEIGHT	24 × 6.5 × 15.1mm [0.94 × 0.26 × 0.59 inches] (W × H × D) / 3g max								
	COOLING METHOD	Convection/Forced air								

*1 Output pins can be connected in series to make a 24V/30V output.
 *2 Rated input 5V, 12V, 24V or 48V DC Io=100%
 *3 Ripple and Ripple Noise is measured by using measuring board with capacitor with in 25mm from output pin terminals.
 *4 Drift is the change in DC output for an eight hour period after a half-hour warm-up at 25°C.
 * Parallel operation with other model is not possible.

External view

1.SMD(type B)

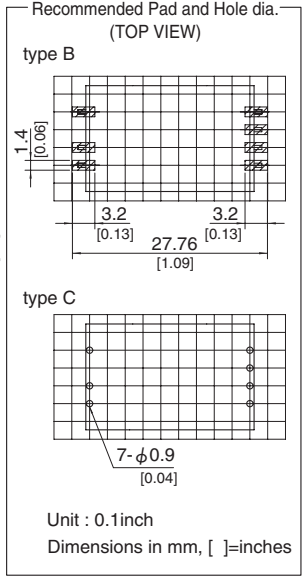
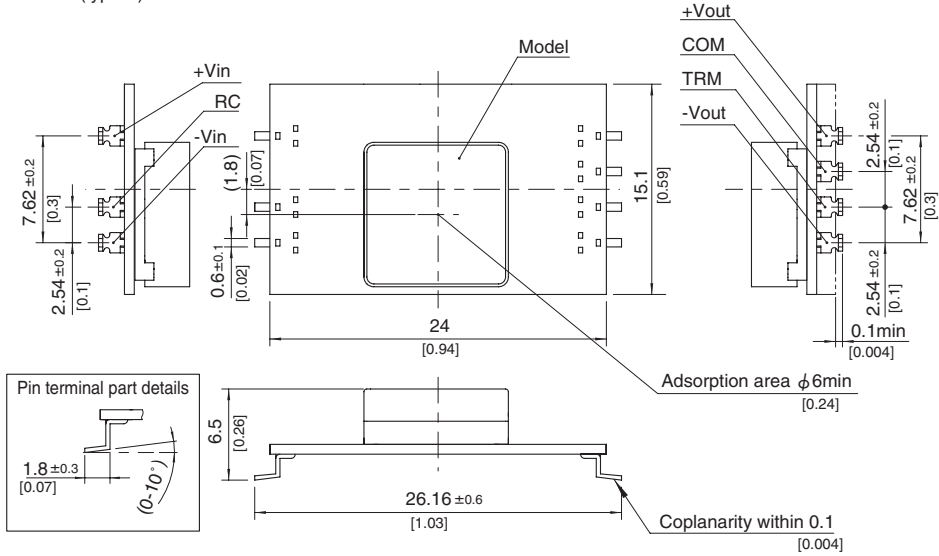

2.DIP(type C)

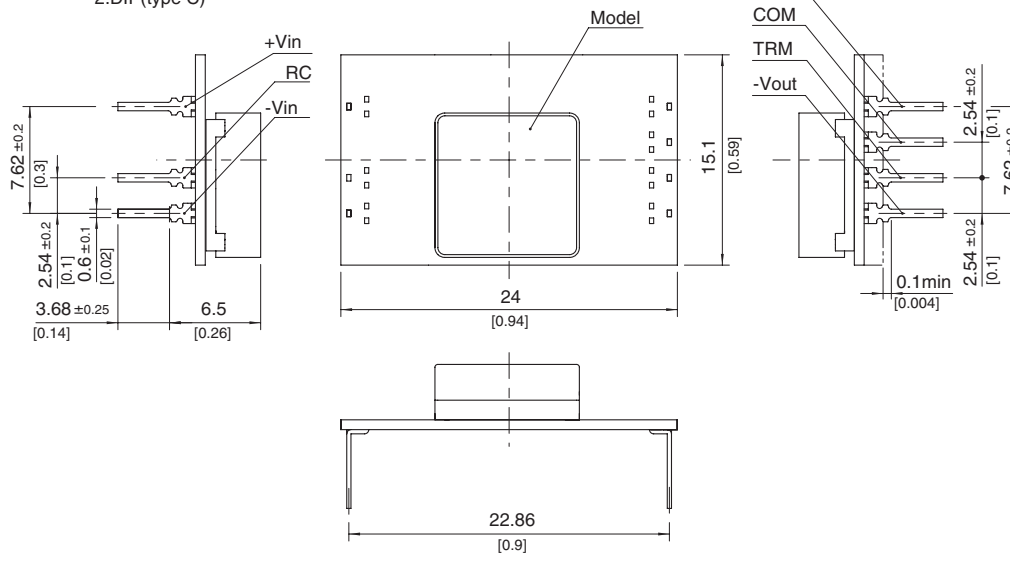

- ※ Tolerance ±0.5 [±0.02]
- ※ Dimensions in mm, []=inches
- ※ Pin terminal thickness : 0.3±0.1 [0.012]
- ※ Pin terminal material : Copper alloy
- ※ Plating treatment of terminal : Lead free plating
- ※ Weight : 3g max

SUS6

SU S 6 12 05 B P - □

① ② ③ ④ ⑤ ⑥ ⑦ ⑧

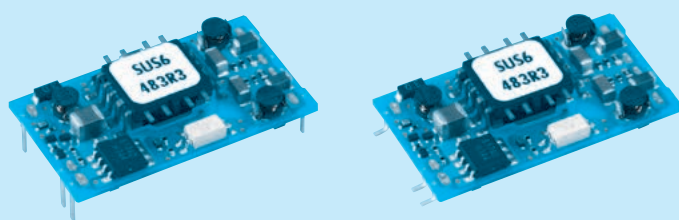
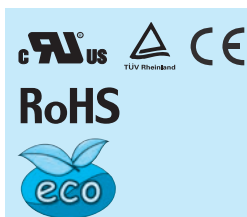

- ① Series name
- ② Single output
- ③ Output wattage
- ④ Input voltage
- ⑤ Output voltage
- ⑥ Mounting type
B : SMD
C : DIP
- ⑦ Packing form
Blank: Plastic cover
P : Tray (SMD type)
- ⑧ Optional
G : Capacitor between Input and Output is removed.

MODEL	SUS6053R3	SUS60505	SUS60512	SUS60515	SUS6123R3	SUS61205	SUS61212	SUS61215	
MAX OUTPUT WATTAGE[W]	3.96	5	6	6	4.46	6	6	6	
DC OUTPUT	VOLTAGE[V] *1	3.3	5	12	15	3.3	5	12	15
	CURRENT[A]	1.2	1	0.5	0.4	1.35	1.2	0.5	0.4

SPECIFICATIONS

	MODEL	SUS6053R3	SUS60505	SUS60512	SUS60515	SUS6123R3	SUS61205	SUS61212	SUS61215	
INPUT	VOLTAGE[V]	DC4.5 - 9				DC9 - 18				
	CURRENT[A] *2	1.100typ	1.316typ	1.500typ	1.500typ	0.502typ	0.617typ	0.588typ	0.588typ	
	EFFICIENCY[%] *2	72typ	76typ	80typ	80typ	74typ	81typ	85typ	85typ	
OUTPUT	VOLTAGE[V]	3.3	5	12	15	3.3	5	12	15	
	CURRENT[A]	1.2	1	0.5	0.4	1.35	1.2	0.5	0.4	
	LINE REGULATION[mV]	20max	20max	48max	60max	20max	20max	48max	60max	
	LOAD REGULATION[mV]	40max	40max	100max	120max	40max	40max	100max	120max	
	RIPPLE[mVp-p]	-20 to +55°C *3	80max	80max	120max	120max	80max	80max	120max	120max
		-40 to -20°C *3	120max	120max	150max	150max	120max	120max	150max	150max
	RIPPLE NOISE[mVp-p]	-20 to +55°C *3	120max	120max	150max	150max	120max	120max	150max	150max
		-40 to -20°C *3	200max	200max	200max	200max	200max	200max	200max	200max
	TEMPERATURE REGULATION[mV]	-20 to +55°C	50max	50max	150max	180max	50max	50max	150max	180max
		-40 to +55°C	80max	80max	240max	290max	80max	80max	240max	290max
	DRIFT[mV] *4	20max	20max	48max	60max	20max	20max	48max	60max	
START-UP TIME[ms]	20max (Minimum input, I _o =100%)									
OUTPUT VOLTAGE ADJUSTMENT RANGE	Fixed (TRM pin open) ±5% adjustable by external VR									
OUTPUT VOLTAGE SETTING[V] (±3%)	3.21 - 3.42	4.90 - 5.21	11.64 - 12.36	14.55 - 15.45	3.21 - 3.42	4.90 - 5.21	11.64 - 12.36	14.55 - 15.45		
PROTECTION CIRCUIT AND OTHERS	OVERCURRENT PROTECTION	Works over 105% of rating and recovers automatically								
	REMOTE ON/OFF	Provided (Negative logic L : ON, H : OFF)								

MODEL	SUS6243R3	SUS62405	SUS62412	SUS62415	SUS6483R3	SUS64805	SUS64812	SUS64815	
MAX OUTPUT WATTAGE[W]	4.46	6	6	6	4.46	6	6	6	
DC OUTPUT	VOLTAGE[V] *1	3.3	5	12	15	3.3	5	12	15
	CURRENT[A]	1.35	1.2	0.5	0.4	1.35	1.2	0.5	0.4

SPECIFICATIONS

	MODEL	SUS6243R3	SUS62405	SUS62412	SUS62415	SUS6483R3	SUS64805	SUS64812	SUS64815	
INPUT	VOLTAGE[V]	DC18 - 36				DC36 - 76				
	CURRENT[A] *2	0.248typ	0.309typ	0.291typ	0.291typ	0.121typ	0.154typ	0.145typ	0.145typ	
	EFFICIENCY[%] *2	75typ	81typ	86typ	86typ	77typ	81typ	86typ	86typ	
OUTPUT	VOLTAGE[V]	3.3	5	12	15	3.3	5	12	15	
	CURRENT[A]	1.35	1.2	0.5	0.4	1.35	1.2	0.5	0.4	
	LINE REGULATION[mV]	20max	20max	48max	60max	20max	20max	48max	60max	
	LOAD REGULATION[mV]	40max	40max	100max	120max	40max	40max	100max	120max	
	RIPPLE[mVp-p]	-20 to +55°C *3	80max	80max	120max	120max	80max	80max	120max	120max
		-40 to -20°C *3	120max	120max	150max	150max	120max	120max	150max	150max
	RIPPLE NOISE[mVp-p]	-20 to +55°C *3	120max	120max	150max	150max	120max	120max	150max	150max
		-40 to -20°C *3	200max	200max	200max	200max	200max	200max	200max	200max
	TEMPERATURE REGULATION[mV]	-20 to +55°C	50max	50max	150max	180max	50max	50max	150max	180max
		-40 to +55°C	80max	80max	240max	290max	80max	80max	240max	290max
	DRIFT[mV] *4	20max	20max	48max	60max	20max	20max	48max	60max	
START-UP TIME[ms]	20max (Minimum input, I _o =100%)									
OUTPUT VOLTAGE ADJUSTMENT RANGE	Fixed (TRM pin open) ±5% adjustable by external VR									
OUTPUT VOLTAGE SETTING[V] (±3%)	3.21 - 3.42	4.90 - 5.21	11.64 - 12.36	14.55 - 15.45	3.21 - 3.42	4.90 - 5.21	11.64 - 12.36	14.55 - 15.45		
PROTECTION CIRCUIT AND OTHERS	OVERCURRENT PROTECTION	Works over 105% of rating and recovers automatically								
	REMOTE ON/OFF	Provided (Negative logic L : ON, H : OFF)								

GENERAL SPECIFICATIONS

ISOLATION	INPUT-OUTPUT	AC500V 1minute, Cutoff current = 10mA, DC500V 50MΩ min (20±15°C)
ENVIRONMENT	OPERATING TEMP.,HUMID.AND ALTITUDE	-40 to +85°C, 20 - 95%RH (Non condensing) (Refer to "Derating"), 3,000m (10,000feet) max
	STORAGE TEMP.,HUMID.AND ALTITUDE	-40 to +100°C, 20 - 95%RH (Non condensing), 9,000m (30,000feet) max
	VIBRATION	10 - 55Hz, 98.0m/s ² (10G), 3minutes period, 60minutes each along X, Y and Z axis
	IMPACT	490.3m/s ² (50G), 11ms, once each along X, Y and Z axis
SAFETY	AGENCY APPROVALS	UL60950-1, C-UL, EN60950-1
OTHERS	CASE SIZE/WEIGHT	31.6×6.5×18.1mm [1.24×0.26×0.71 inches] (W×H×D) / 4g max
	COOLING METHOD	Convection/Forced air

- *1 SUW6xx12/SUW6xx15 is available as single output, +24V/+30V.
- *2 Rated input 5V, 12V, 24V or 48V DC I_o=100%
- *3 Ripple and Ripple Noise is measured by using measuring board with capacitor with in 25mm from output pin terminals.
- *4 Drift is the change in DC output for an eight hour period after a half-hour warm-up at 25°C.
- * Parallel operation with other model is not possible.

External view

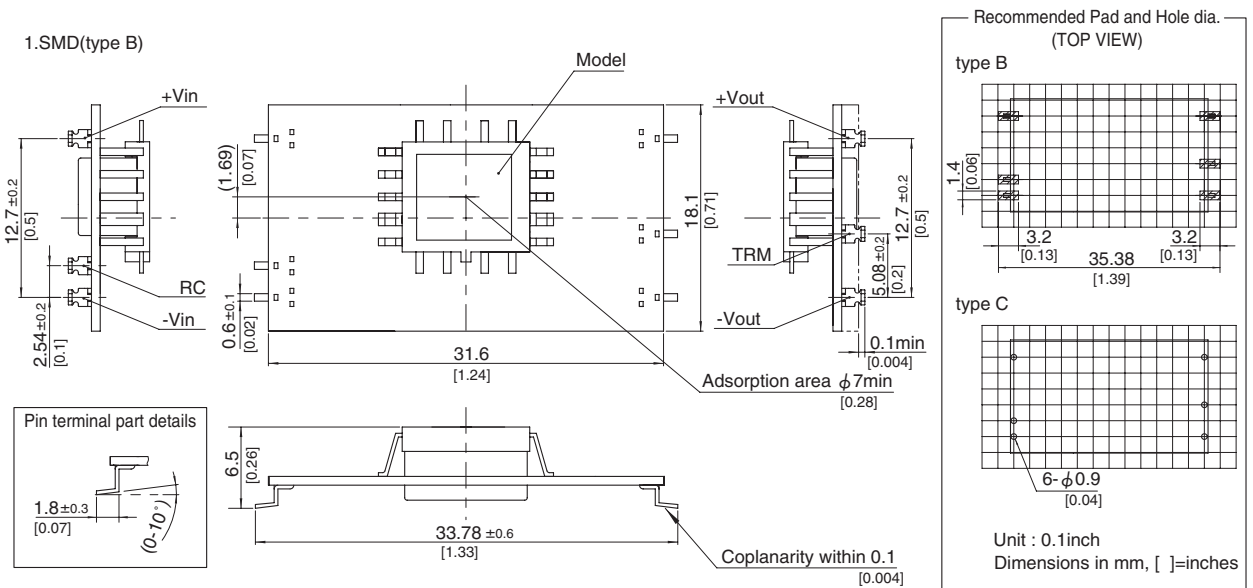

- ※ Tolerance ±0.5 [±0.02]
- ※ Dimensions in mm, []=inches
- ※ Pin terminal thickness : 0.3±0.1 [0.012]
- ※ Pin terminal material : Copper alloy
- ※ Plating treatment of terminal : Lead free plating
- ※ Weight : 4g max

SUW6

SU W 6 12 12 B P - □
 ① ② ③ ④ ⑤ ⑥ ⑦ ⑧

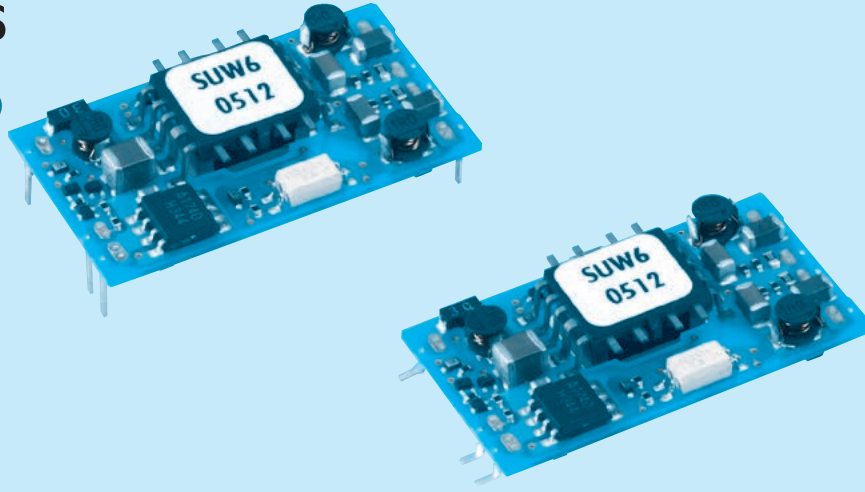

- ① Series name
- ② Dual output
- ③ Output wattage
- ④ Input voltage
- ⑤ Output voltage
- ⑥ Mounting type
B : SMD
C : DIP
- ⑦ Packing form
Blank: Plastic cover
P : Tray (SMD type)
- ⑧ Optional
G : Capacitor between Input and Output is removed.

MODEL	SUW60512	SUW60515	SUW61212	SUW61215	SUW62412	SUW62415	SUW64812	SUW64815	
MAX OUTPUT WATTAGE[W]	6	6	6	6	6	6	6	6	
DC OUTPUT	VOLTAGE[V] *1	±12 or +24	±15 or +30	±12 or +24	±15 or +30	±12 or +24	±15 or +30	±12 or +24	±15 or +30
	CURRENT[A]	0.25	0.2	0.25	0.2	0.25	0.2	0.25	0.2

SPECIFICATIONS

MODEL	SUW60512	SUW60515	SUW61212	SUW61215	SUW62412	SUW62415	SUW64812	SUW64815		
INPUT	VOLTAGE[V]	DC4.5 - 9		DC9 - 18		DC18 - 36		DC36 - 76		
	CURRENT[A] *2	1.538typ	1.538typ	0.588typ	0.588typ	0.291typ	0.291typ	0.145typ	0.145typ	
	EFFICIENCY[%] *2	78typ	78typ	85typ	85typ	86typ	86typ	86typ	86typ	
OUTPUT	VOLTAGE[V]	±12(+24)	±15(+30)	±12(+24)	±15(+30)	±12(+24)	±15(+30)	±12(+24)	±15(+30)	
	CURRENT[A]	0.25	0.2	0.25	0.2	0.25	0.2	0.25	0.2	
	LINE REGULATION[mV]	60max	75max	60max	75max	60max	75max	60max	75max	
	LOAD REGULATION[mV]	600max	750max	600max	750max	600max	750max	600max	750max	
	RIPPLE[mVp-p]	-20 to +55°C *3	120max	120max	120max	120max	120max	120max	120max	120max
		-40 to -20°C *3	150max	150max	150max	150max	150max	150max	150max	150max
	RIPPLE NOISE[mVp-p]	-20 to +55°C *3	150max	150max	150max	150max	150max	150max	150max	150max
		-40 to -20°C *3	200max	200max	200max	200max	200max	200max	200max	200max
	TEMPERATURE REGULATION[mV]	-20 to +55°C	150max	180max	150max	180max	150max	180max	150max	180max
		-40 to +55°C	240max	290max	240max	290max	240max	290max	240max	290max
DRIFT[mV] *4	50max	60max	50max	60max	50max	60max	50max	60max		
START-UP TIME[ms]	20max (Minimum input, Io=100%)									
OUTPUT VOLTAGE ADJUSTMENT RANGE	Fixed (TRM pin open) ±5% adjustable by external VR									
OUTPUT VOLTAGE SETTING[V] (±5%)	11.40 - 12.60	14.25 - 15.75	11.40 - 12.60	14.25 - 15.75	11.40 - 12.60	14.25 - 15.75	11.40 - 12.60	14.25 - 15.75		
PROTECTION CIRCUIT AND OTHERS	OVERCURRENT PROTECTION	Works over 105% of rating and recovers automatically								
	REMOTE ON/OFF	Provided (Negative logic L : ON, H : OFF)								
ISOLATION	INPUT-OUTPUT	AC500V 1minute. Cutoff current = 10mA. DC500V 50MΩ min (20±15°C)								
ENVIRONMENT	OPERATING TEMP., HUMID. AND ALTITUDE	-40 to +85°C, 20 - 95%RH (Non condensing) (Refer to "Derating"), 3,000m (10,000feet) max								
	STORAGE TEMP., HUMID. AND ALTITUDE	-40 to +100°C, 20 - 95%RH (Non condensing), 9,000m (30,000feet) max								
	VIBRATION	10 - 55Hz, 98.0m/s ² (10G), 3minutes period, 60minutes each along X, Y and Z axis								
	IMPACT	490.3m/s ² (50G), 11ms. once each along X, Y and Z axis								
SAFETY	AGENCY APPROVALS	UL60950-1, C-UL, EN60950-1								
OTHERS	CASE SIZE/WEIGHT	31.6 × 6.5 × 18.1mm [1.24 × 0.26 × 0.71 inches] (W × H × D) / 4g max								
	COOLING METHOD	Convection/Forced air								

*1 Output pins can be connected in series to make a 24V/30V output.
 *2 Rated input 5V, 12V, 24V or 48V DC Io=100%
 *3 Ripple and Ripple Noise is measured by using measuring board with capacitor with in 25mm from output pin terminals.
 *4 Drift is the change in DC output for an eight hour period after a half-hour warm-up at 25°C.
 * Parallel operation with other model is not possible.

External view

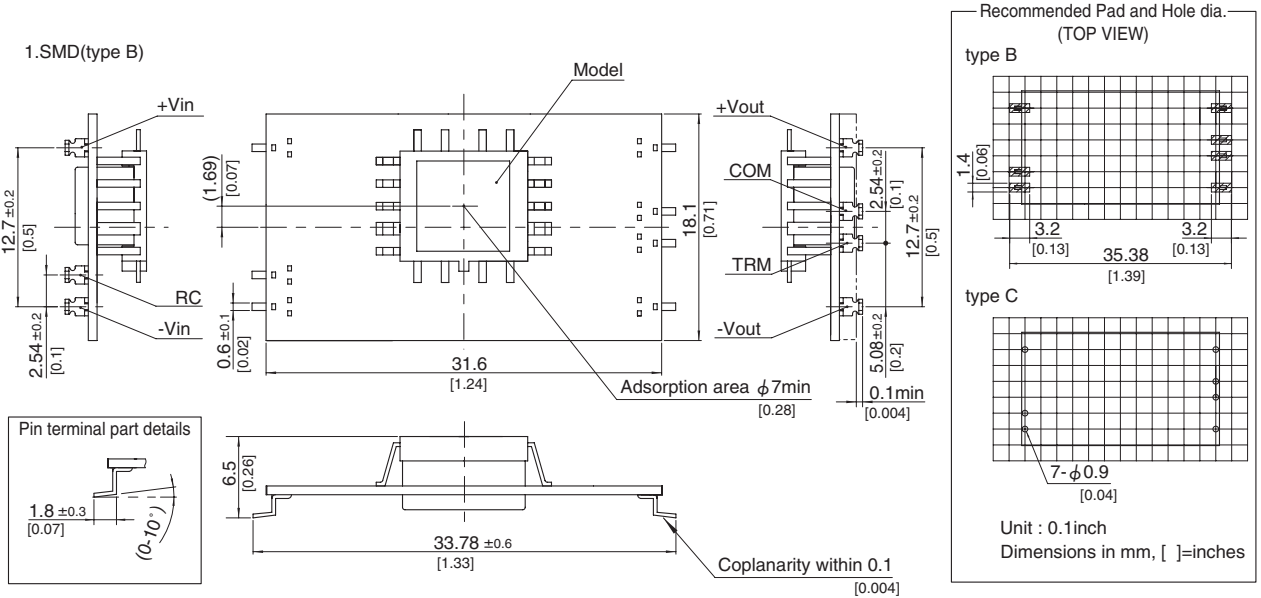

- ※ Tolerance ±0.5 [±0.02]
- ※ Dimensions in mm, []=inches
- ※ Pin terminal thickness : 0.3±0.1 [0.012]
- ※ Pin terminal material : Copper alloy
- ※ Plating treatment of terminal : Lead free plating
- ※ Weight : 4g max

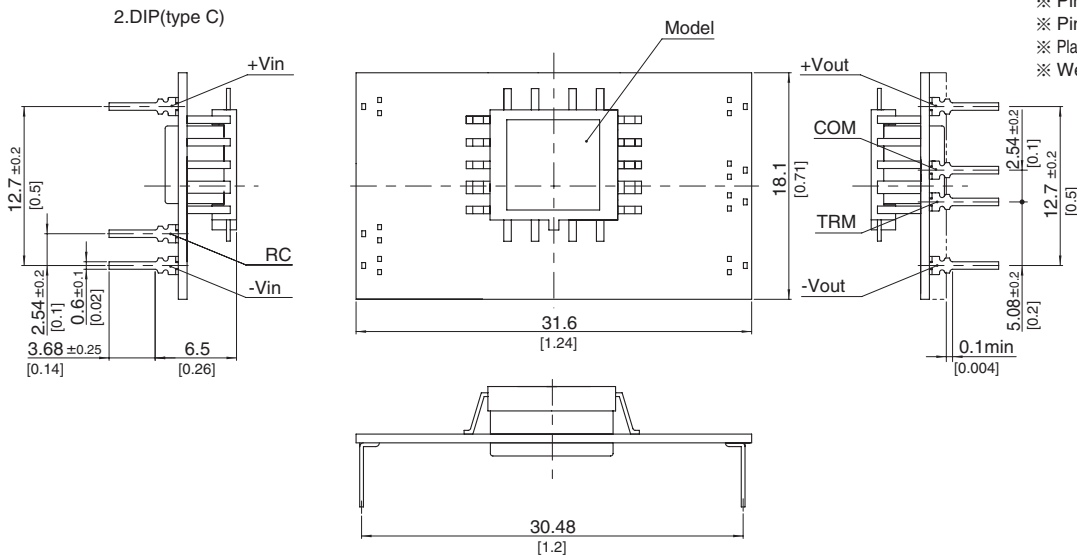

SUS10

SU S 10 12 05 B P - □

① ② ③ ④ ⑤ ⑥ ⑦ ⑧

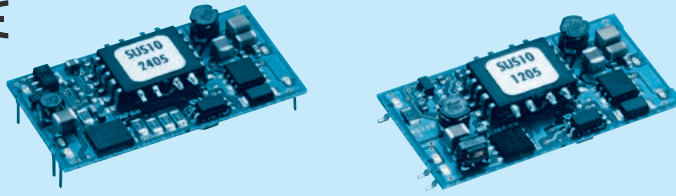
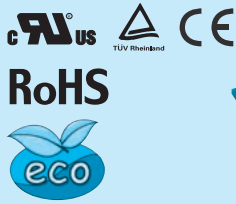

- ① Series name
- ② Single output
- ③ Output wattage
- ④ Input voltage
- ⑤ Output voltage
- ⑥ Mounting type
B : SMD
C : DIP
- ⑦ Packing form
Blank: Plastic cover
P : Tray (SMD type)
- ⑧ Optional
G : Capacitor between Input and Output is removed.

MODEL	SUS10053R3	SUS100505	SUS100512	SUS100515	SUS10123R3	SUS101205	SUS101212	SUS101215
MAX OUTPUT WATTAGE[W]	8.58	10	10.8	10.5	8.58	10	12	12
DC OUTPUT	VOLTAGE[V] *1	3.3	5	12	15	3.3	5	12
	CURRENT[A]	2.6	2	0.9	0.7	2.6	2	1

SPECIFICATIONS

	MODEL	SUS10053R3	SUS100505	SUS100512	SUS100515	SUS10123R3	SUS101205	SUS101212	SUS101215	
INPUT	VOLTAGE[V]	DC4.5 - 9				DC9 - 18				
	CURRENT[A] *2	2.12typ	2.41typ	2.54typ	2.47typ	0.872typ	0.980typ	1.15typ	1.15typ	
	EFFICIENCY[%] *2	81typ	83typ	85typ	85typ	82typ	85typ	87typ	87typ	
OUTPUT	VOLTAGE[V]	3.3	5	12	15	3.3	5	12	15	
	CURRENT[A]	2.6	2	0.9	0.7	2.6	2	1	0.8	
	LINE REGULATION[mV]	20max	20max	48max	60max	20max	20max	48max	60max	
	LOAD REGULATION[mV]	40max	40max	100max	120max	40max	40max	100max	120max	
	RIPPLE[mVp-p]	-20 to +55°C *3	80max	80max	120max	120max	80max	80max	120max	120max
		-40 to -20°C *3	120max	120max	150max	150max	120max	120max	150max	150max
	RIPPLE NOISE[mVp-p]	-20 to +55°C *3	120max	120max	150max	150max	120max	120max	150max	150max
		-40 to -20°C *3	200max	200max	200max	200max	200max	200max	200max	200max
	TEMPERATURE REGULATION[mV]	-20 to +55°C	50max	50max	150max	180max	50max	50max	150max	180max
		-40 to +55°C	80max	80max	240max	290max	80max	80max	240max	290max
	DRIFT[mV] *4	20max	20max	48max	60max	20max	20max	48max	60max	
START-UP TIME[ms]	20max (Minimum input, Io=100%)									
OUTPUT VOLTAGE ADJUSTMENT RANGE	Fixed (TRM pin open) ±5% adjustable by external VR									
OUTPUT VOLTAGE SETTING[V] (±3%)	3.21 - 3.42	4.90 - 5.21	11.64 - 12.36	14.55 - 15.45	3.21 - 3.42	4.90 - 5.21	11.64 - 12.36	14.55 - 15.45		
PROTECTION CIRCUIT AND OTHERS	OVERCURRENT PROTECTION	Works over 105% of rating and recovers automatically								
	REMOTE ON/OFF	Provided (Negative logic L : ON, H : OFF)								

MODEL	SUS10243R3	SUS102405	SUS102412	SUS102415	SUS10483R3	SUS104805	SUS104812	SUS104815
MAX OUTPUT WATTAGE[W]	8.58	10	12	12	8.58	10	12	12
DC OUTPUT	VOLTAGE[V] *1	3.3	5	12	15	3.3	5	12
	CURRENT[A]	2.6	2	1	0.8	2.6	2	1

SPECIFICATIONS

	MODEL	SUS10243R3	SUS102405	SUS102412	SUS102415	SUS10483R3	SUS104805	SUS104812	SUS104815	
INPUT	VOLTAGE[V]	DC18 - 36				DC36 - 76				
	CURRENT[A] *2	0.436typ	0.490typ	0.575typ	0.575typ	0.218typ	0.245typ	0.287typ	0.287typ	
	EFFICIENCY[%] *2	82typ	85typ	87typ	87typ	82typ	85typ	87typ	87typ	
OUTPUT	VOLTAGE[V]	3.3	5	12	15	3.3	5	12	15	
	CURRENT[A]	2.6	2	1	0.8	2.6	2	1	0.8	
	LINE REGULATION[mV]	20max	20max	48max	60max	20max	20max	48max	60max	
	LOAD REGULATION[mV]	40max	40max	100max	120max	40max	40max	100max	120max	
	RIPPLE[mVp-p]	-20 to +55°C *3	80max	80max	120max	120max	80max	80max	120max	120max
		-40 to -20°C *3	120max	120max	150max	150max	120max	120max	150max	150max
	RIPPLE NOISE[mVp-p]	-20 to +55°C *3	120max	120max	150max	150max	120max	120max	150max	150max
		-40 to -20°C *3	200max	200max	200max	200max	200max	200max	200max	200max
	TEMPERATURE REGULATION[mV]	-20 to +55°C	50max	50max	150max	180max	50max	50max	150max	180max
		-40 to +55°C	80max	80max	240max	290max	80max	80max	240max	290max
	DRIFT[mV] *4	20max	20max	48max	60max	20max	20max	48max	60max	
START-UP TIME[ms]	20max (Minimum input, Io=100%)									
OUTPUT VOLTAGE ADJUSTMENT RANGE	Fixed (TRM pin open) ±5% adjustable by external VR									
OUTPUT VOLTAGE SETTING[V] (±3%)	3.21 - 3.42	4.90 - 5.21	11.64 - 12.36	14.55 - 15.45	3.21 - 3.42	4.90 - 5.21	11.64 - 12.36	14.55 - 15.45		
PROTECTION CIRCUIT AND OTHERS	OVERCURRENT PROTECTION	Works over 105% of rating and recovers automatically								
	REMOTE ON/OFF	Provided (Negative logic L : ON, H : OFF)								

SUW10

SU W 10 12 12 B P - □
 ① ② ③ ④ ⑤ ⑥ ⑦ ⑧

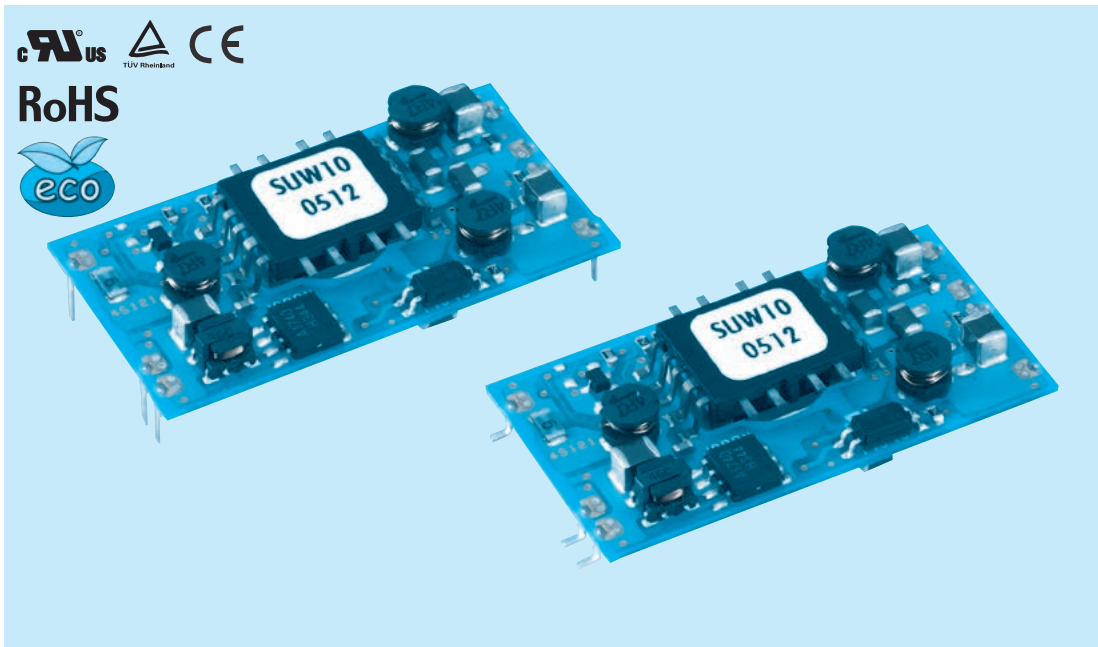

- ① Series name
- ② Dual output
- ③ Output wattage
- ④ Input voltage
- ⑤ Output voltage
- ⑥ Mounting type
B : SMD
C : DIP
- ⑦ Packing form
Blank: Plastic cover
P : Tray(SMD type)
- ⑧ Optional
G : Capacitor between Input and Output is removed.

MODEL	SUW100512	SUW100515	SUW101212	SUW101215	SUW102412	SUW102415	SUW104812	SUW104815	
MAX OUTPUT WATTAGE[W]	10.8	10.5	10.8	10.5	10.8	10.5	10.8	10.5	
DC OUTPUT	VOLTAGE[V] *1	±12 or +24	±15 or +30	±12 or +24	±15 or +30	±12 or +24	±15 or +30	±12 or +24	±15 or +30
	CURRENT[A]	0.45	0.35	0.45	0.35	0.45	0.35	0.45	0.35

SPECIFICATIONS

MODEL	SUW100512	SUW100515	SUW101212	SUW101215	SUW102412	SUW102415	SUW104812	SUW104815		
INPUT	VOLTAGE[V]	DC4.5 - 9		DC9 - 18		DC18 - 36		DC36 - 76		
	CURRENT[A] *2	2.51typ	2.44typ	1.05typ	1.02typ	0.523typ	0.509typ	0.262typ	0.254typ	
	EFFICIENCY[%] *2	86typ	86typ	86typ	86typ	86typ	86typ	86typ	86typ	
OUTPUT	VOLTAGE[V]	±12(+24)	±15(+30)	±12(+24)	±15(+30)	±12(+24)	±15(+30)	±12(+24)	±15(+30)	
	CURRENT[A]	0.45	0.35	0.45	0.35	0.45	0.35	0.45	0.35	
	LINE REGULATION[mV]	60max	75max	60max	75max	60max	75max	60max	75max	
	LOAD REGULATION[mV]	600max	750max	600max	750max	600max	750max	600max	750max	
	RIPPLE[mVp-p]	-20 to +55°C *3	120max	120max	120max	120max	120max	120max	120max	120max
		-40 to -20°C *3	150max	150max	150max	150max	150max	150max	150max	150max
	RIPPLE NOISE[mVp-p]	-20 to +55°C *3	150max	150max	150max	150max	150max	150max	150max	150max
		-40 to -20°C *3	200max	200max	200max	200max	200max	200max	200max	200max
	TEMPERATURE REGULATION[mV]	-20 to +55°C	150max	180max	150max	180max	150max	180max	150max	180max
		-40 to +55°C	240max	290max	240max	290max	240max	290max	240max	290max
DRIFT[mV] *4	50max	60max	50max	60max	50max	60max	50max	60max		
START-UP TIME[ms]	20max (Minimum input, Io=100%)									
OUTPUT VOLTAGE ADJUSTMENT RANGE	Fixed (TRM pin open) ±5% adjustable by external VR									
OUTPUT VOLTAGE SETTING[V] (±5%)	11.40 - 12.60	14.25 - 15.75	11.40 - 12.60	14.25 - 15.75	11.40 - 12.60	14.25 - 15.75	11.40 - 12.60	14.25 - 15.75		
PROTECTION CIRCUIT AND OTHERS	OVERCURRENT PROTECTION	Works over 105% of rating and recovers automatically								
	REMOTE ON/OFF	Provided (Negative logic L : ON, H : OFF)								
ISOLATION	INPUT-OUTPUT	AC500V 1minute. Cutoff current = 10mA. DC500V 50MΩ min (20±15°C)								
ENVIRONMENT	OPERATING TEMP., HUMID. AND ALTITUDE	-40 to +85°C, 20 - 95%RH (Non condensing) (Refer to "Derating"), 3,000m (10,000feet) max								
	STORAGE TEMP., HUMID. AND ALTITUDE	-40 to +100°C, 20 - 95%RH (Non condensing), 9,000m (30,000feet) max								
	VIBRATION	10 - 55Hz, 98.0m/s ² (10G), 3minutes period, 60minutes each along X, Y and Z axis								
	IMPACT	490.3m/s ² (50G), 11ms. once each along X, Y and Z axis								
SAFETY	AGENCY APPROVALS	UL60950-1, C-UL, EN60950-1								
OTHERS	CASE SIZE/WEIGHT	39.2 × 6.5 × 21.0mm [1.54 × 0.26 × 0.83 inches] (W × H × D) / 6g max								
	COOLING METHOD	Convection/Forced air								

*1 Output pins can be connected in series to make a 24V/30V output.
 *2 Rated input 5V, 12V, 24V or 48V DC Io=100%
 *3 Ripple and Ripple Noise is measured by using measuring board with capacitor with in 25mm from output pin terminals.
 *4 Drift is the change in DC output for an eight hour period after a half-hour warm-up at 25°C.
 * Parallel operation with other model is not possible.

External view

1.SMD(type B)

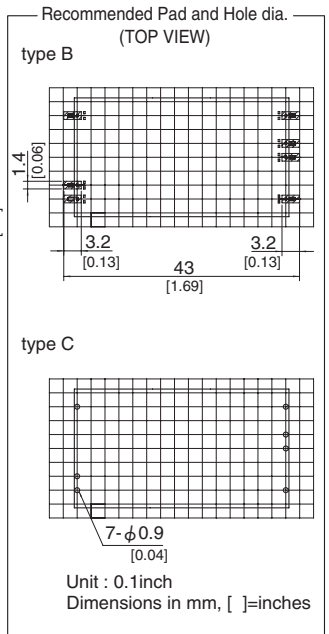
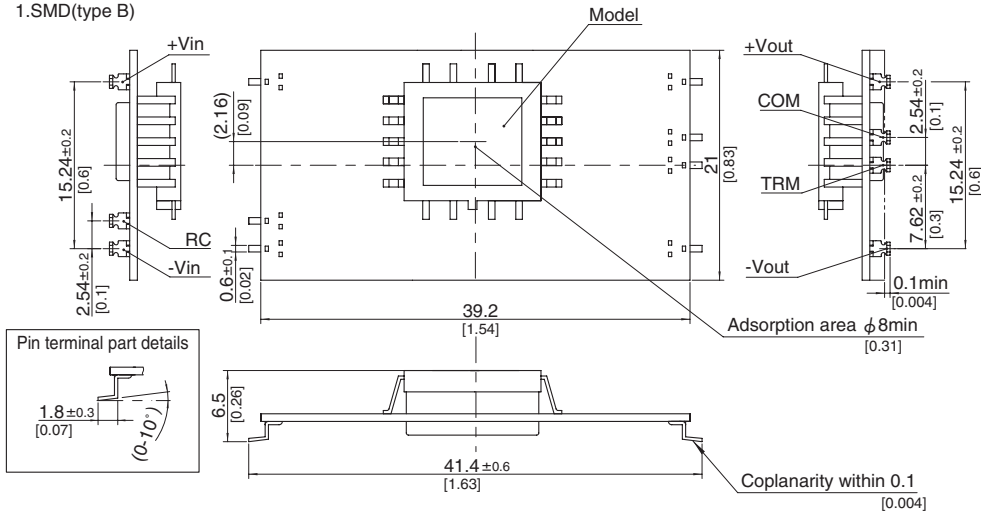

2.DIP(type C)

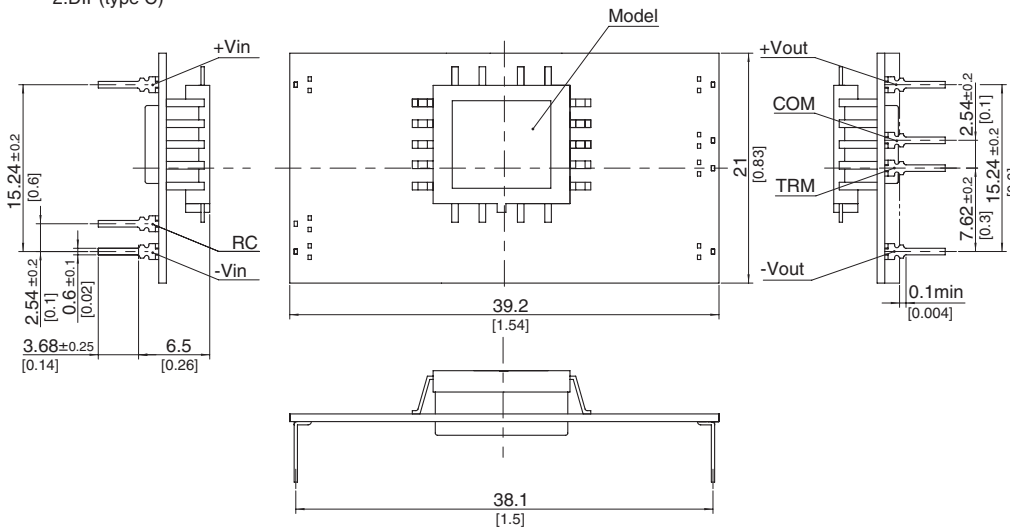

- ※ Tolerance ±0.5 [±0.02]
- ※ Dimensions in mm, []=inches
- ※ Pin terminal thickness : 0.3±0.1 [0.012]
- ※ Pin terminal material : Copper alloy
- ※ Plating treatment of terminal : Lead free plating
- ※ Weight : 6g max

SUCS1R5

SUC S 1R5 12 05 B P - □

① ② ③ ④ ⑤ ⑥ ⑦ ⑧

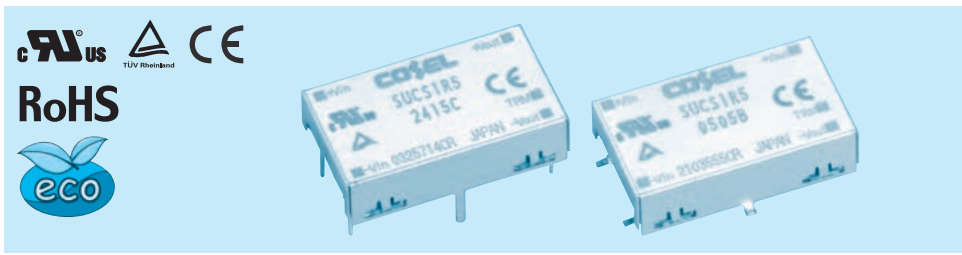

- ① Series name
 - ② Single output
 - ③ Output wattage
 - ④ Input voltage
 - ⑤ Output voltage
 - ⑥ Mounting type
B :SMD
C :DIP
 - ⑦ Packing form
Blank:Plastic cover
P :Tray (SMD type)
 - ⑧ Optional
C :with coating (only DIP type)*
- *Safety standards are pending

MODEL	SUCS1R5053R3	SUCS1R50505	SUCS1R50512	SUCS1R50515	SUCS1R5123R3	SUCS1R51205	SUCS1R51212	SUCS1R51215
MAX OUTPUT WATTAGE[W]	1.32	1.5	1.56	1.5	1.32	1.5	1.56	1.5
DC OUTPUT	VOLTAGE[V] *1	3.3	5	12	15	3.3	5	12
	CURRENT[A]	0.4	0.3	0.13	0.1	0.4	0.3	0.13

SPECIFICATIONS

	MODEL	SUCS1R5053R3	SUCS1R50505	SUCS1R50512	SUCS1R50515	SUCS1R5123R3	SUCS1R51205	SUCS1R51212	SUCS1R51215	
INPUT	VOLTAGE[V]	DC4.5 - 9				DC9 - 18				
	CURRENT[A] *2	0.388typ	0.417typ	0.433typ	0.417typ	0.157typ	0.169typ	0.176typ	0.169typ	
	EFFICIENCY[%] *2	68typ	72typ	72typ	72typ	70typ	74typ	74typ	74typ	
OUTPUT	VOLTAGE[V]	3.3	5	12	15	3.3	5	12	15	
	CURRENT[A]	0.4	0.3	0.13	0.1	0.4	0.3	0.13	0.1	
	LINE REGULATION[mV]	20max	20max	48max	60max	20max	20max	48max	60max	
	LOAD REGULATION[mV]	40max	40max	100max	120max	40max	40max	100max	120max	
	RIPPLE[mVp-p]	-20 to +55°C *3	80max	80max	120max	120max	80max	80max	120max	120max
		-40 to -20°C *3	120max	120max	150max	150max	120max	120max	150max	150max
	RIPPLE NOISE[mVp-p]	-20 to +55°C *3	120max	120max	150max	150max	120max	120max	150max	150max
		-40 to -20°C *3	200max	200max	200max	200max	200max	200max	200max	200max
	TEMPERATURE REGULATION[mV]	-20 to +55°C	50max	50max	150max	180max	50max	50max	150max	180max
		-40 to +55°C	80max	80max	240max	290max	80max	80max	240max	290max
DRIFT[mV] *4	20max	20max	48max	60max	20max	20max	48max	60max		
START-UP TIME[ms]	20max (Minimum input, Io=100%)									
OUTPUT VOLTAGE ADJUSTMENT RANGE	Fixed (TRM pin open) ±5% adjustable by external VR									
OUTPUT VOLTAGE SETTING[V] (±3%)	3.21 - 3.42	4.90 - 5.21	11.64 - 12.36	14.55 - 15.45	3.21 - 3.42	4.90 - 5.21	11.64 - 12.36	14.55 - 15.45		
OVERCURRENT PROTECTION	Works over 105% of rating and recovers automatically									

PROTECTION CIRCUIT AND OTHERS

MODEL	SUCS1R5243R3	SUCS1R52405	SUCS1R52412	SUCS1R52415	SUCS1R5483R3	SUCS1R54805	SUCS1R54812	SUCS1R54815
MAX OUTPUT WATTAGE[W]	1.32	1.5	1.56	1.5	1.32	1.5	1.56	1.5
DC OUTPUT	VOLTAGE[V] *1	3.3	5	12	15	3.3	5	12
	CURRENT[A]	0.4	0.3	0.13	0.1	0.4	0.3	0.13

SPECIFICATIONS

	MODEL	SUCS1R5243R3	SUCS1R52405	SUCS1R52412	SUCS1R52415	SUCS1R5483R3	SUCS1R54805	SUCS1R54812	SUCS1R54815	
INPUT	VOLTAGE[V]	DC18 - 36				DC36 - 76				
	CURRENT[A] *2	0.079typ	0.084typ	0.087typ	0.083typ	0.039typ	0.042typ	0.043typ	0.042typ	
	EFFICIENCY[%] *2	70typ	74typ	75typ	75typ	70typ	74typ	75typ	75typ	
OUTPUT	VOLTAGE[V]	3.3	5	12	15	3.3	5	12	15	
	CURRENT[A]	0.4	0.3	0.13	0.1	0.4	0.3	0.13	0.1	
	LINE REGULATION[mV]	20max	20max	48max	60max	20max	20max	48max	60max	
	LOAD REGULATION[mV]	40max	40max	100max	120max	40max	40max	100max	120max	
	RIPPLE[mVp-p]	-20 to +55°C *3	80max	80max	120max	120max	80max	80max	120max	120max
		-40 to -20°C *3	120max	120max	150max	150max	120max	120max	150max	150max
	RIPPLE NOISE[mVp-p]	-20 to +55°C *3	120max	120max	150max	150max	120max	120max	150max	150max
		-40 to -20°C *3	200max	200max	200max	200max	200max	200max	200max	200max
	TEMPERATURE REGULATION[mV]	-20 to +55°C	50max	50max	150max	180max	50max	50max	150max	180max
		-40 to +55°C	80max	80max	240max	290max	80max	80max	240max	290max
DRIFT[mV] *4	20max	20max	48max	60max	20max	20max	48max	60max		
START-UP TIME[ms]	20max (Minimum input, Io=100%)									
OUTPUT VOLTAGE ADJUSTMENT RANGE	Fixed (TRM pin open) ±5% adjustable by external VR									
OUTPUT VOLTAGE SETTING[V] (±3%)	3.21 - 3.42	4.90 - 5.21	11.64 - 12.36	14.55 - 15.45	3.21 - 3.42	4.90 - 5.21	11.64 - 12.36	14.55 - 15.45		
OVERCURRENT PROTECTION	Works over 105% of rating and recovers automatically									

PROTECTION CIRCUIT AND OTHERS

GENERAL SPECIFICATIONS

ISOLATION	INPUT-OUTPUT	AC500V 1minute, Cutoff current = 10mA, DC500V 50M Ω min (20 \pm 15 $^{\circ}$ C)
	INPUT-CASE	AC500V 1minute, Cutoff current = 10mA, DC500V 50M Ω min (20 \pm 15 $^{\circ}$ C)
	OUTPUT-CASE	AC500V 1minute, Cutoff current = 10mA, DC500V 50M Ω min (20 \pm 15 $^{\circ}$ C)
ENVIRONMENT	OPERATING TEMP., HUMID. AND ALTITUDE	-40 to +85 $^{\circ}$ C, 20 - 95%RH (Non condensing) (Refer to "Derating"), 3,000m (10,000feet) max
	STORAGE TEMP., HUMID. AND ALTITUDE	-40 to +100 $^{\circ}$ C, 20 - 95%RH (Non condensing), 9,000m (30,000feet) max
	VIBRATION	10 - 55Hz, 98.0m/s 2 (10G), 3minutes period, 60minutes each along X, Y and Z axis
	IMPACT	490.3m/s 2 (50G), 11ms, once each along X, Y and Z axis
SAFETY	AGENCY APPROVALS	UL60950-1, C-UL, EN60950-1
OTHERS	CASE SIZE/WEIGHT	22.4 x 7.0 x 13.2mm [0.88 x 0.28 x 0.52 inches] (W x H x D) / 3g max
	COOLING METHOD	Convection/Forced air

- *1 SUCW1R5xx12/SUCW1R5xx15 is available as single output, +24V/+30V.
- *2 Rated input 5V, 12V, 24V or 48V DC I_o=100%
- *3 Ripple and Ripple Noise is measured by using measuring board with capacitor with in 25mm from output pin terminals.
- *4 Drift is the change in DC output for an eight hour period after a half-hour warm-up at 25 $^{\circ}$ C.
- * Parallel operation with other model is not possible.

External view

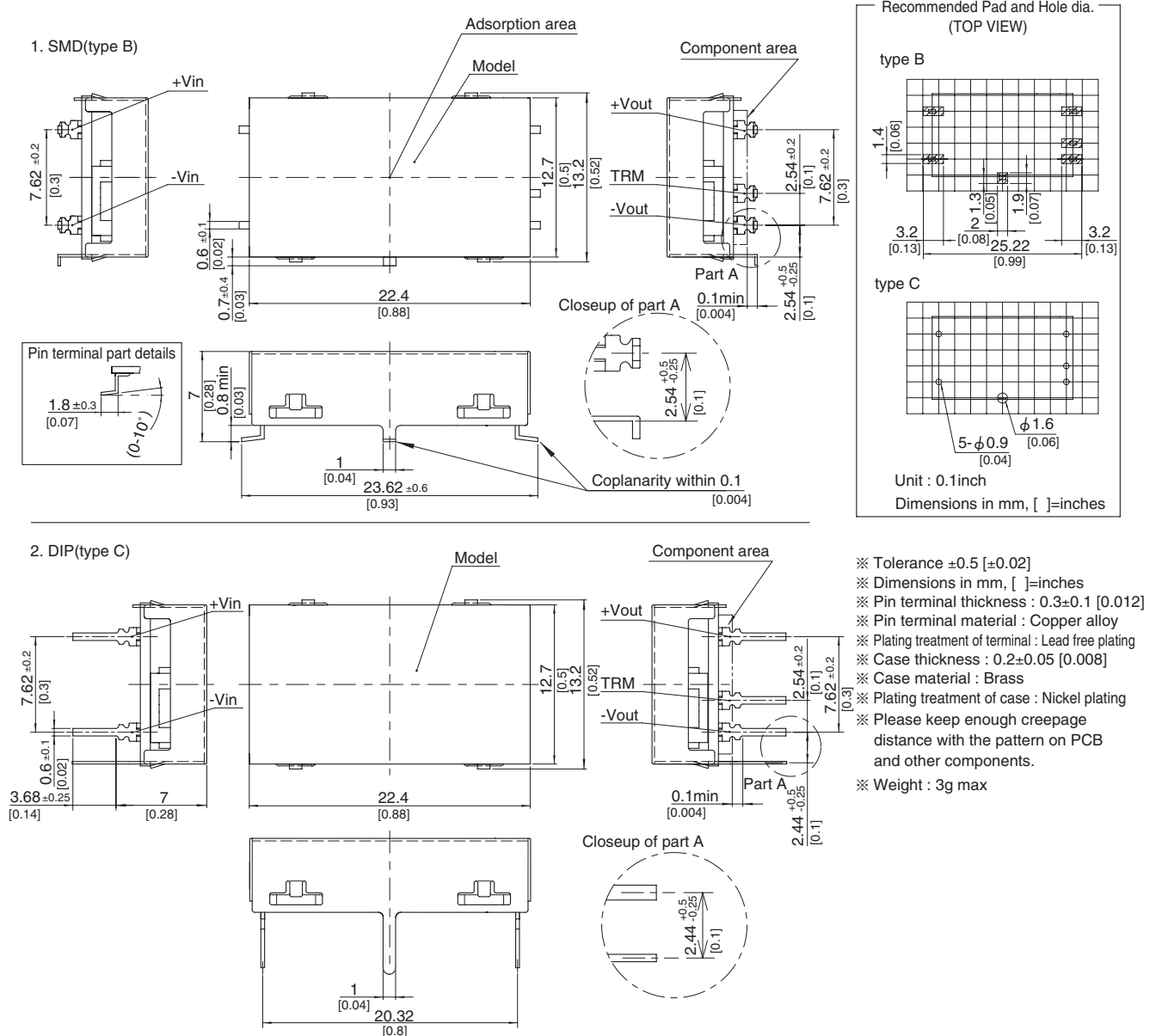

SUCW1R5

SUC W 1R5 12 12 B P -□

① ② ③ ④ ⑤ ⑥ ⑦ ⑧

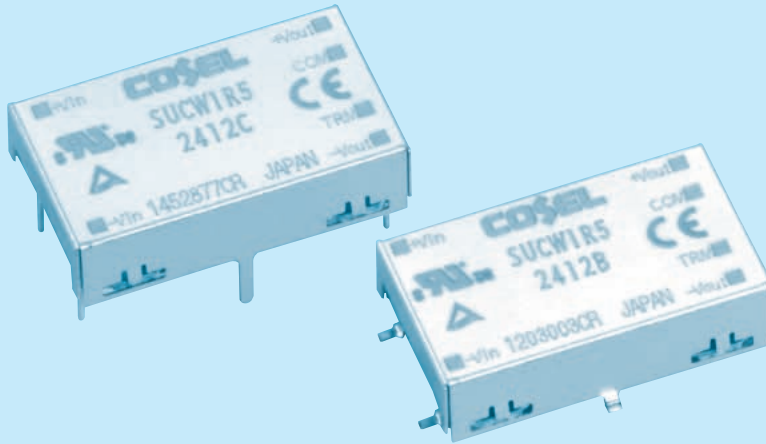
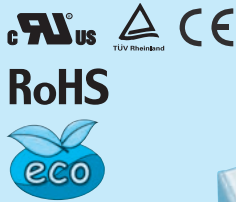

- ① Series name
 - ② Dual output
 - ③ Output wattage
 - ④ Input voltage
 - ⑤ Output voltage
 - ⑥ Mounting type
B :SMD
C :DIP
 - ⑦ Packing form
Blank:Plastic cover
P :Tray (SMD type)
 - ⑧ Optional
C :with coating (only DIP type)*
- * Safety standards are pending

MODEL	SUCW1R50512	SUCW1R50515	SUCW1R51212	SUCW1R51215	SUCW1R52412	SUCW1R52415	SUCW1R54812	SUCW1R54815	
MAX OUTPUT WATTAGE[W]	1.56	1.5	1.56	1.5	1.56	1.5	1.56	1.5	
DC OUTPUT	VOLTAGE[V] *1	± 12 or +24	± 15 or +30	± 12 or +24	± 15 or +30	± 12 or +24	± 15 or +30	± 12 or +24	± 15 or +30
	CURRENT[A]	0.065	0.05	0.065	0.05	0.065	0.05	0.065	0.05

SPECIFICATIONS

	MODEL	SUCW1R50512	SUCW1R50515	SUCW1R51212	SUCW1R51215	SUCW1R52412	SUCW1R52415	SUCW1R54812	SUCW1R54815	
INPUT	VOLTAGE[V]	DC4.5 - 9		DC9 - 18		DC18 - 36		DC36 - 76		
	CURRENT[A] *2	0.446typ	0.429typ	0.178typ	0.171typ	0.089typ	0.086typ	0.045typ	0.043typ	
	EFFICIENCY[%] *2	70typ	70typ	73typ	73typ	73typ	73typ	73typ	73typ	
OUTPUT	VOLTAGE[V]	± 12(+24)	± 15(+30)	± 12(+24)	± 15(+30)	± 12(+24)	± 15(+30)	± 12(+24)	± 15(+30)	
	CURRENT[A]	0.065	0.05	0.065	0.05	0.065	0.05	0.065	0.05	
	LINE REGULATION[mV]	60max	75max	60max	75max	60max	75max	60max	75max	
	LOAD REGULATION[mV]	600max	750max	600max	750max	600max	750max	600max	750max	
	RIPPLE[mVp-p]	-20 to +55°C *3	120max	120max	120max	120max	120max	120max	120max	120max
		-40 to -20°C *3	150max	150max	150max	150max	150max	150max	150max	150max
	RIPPLE NOISE[mVp-p]	-20 to +55°C *3	150max	150max	150max	150max	150max	150max	150max	150max
		-40 to -20°C *3	200max	200max	200max	200max	200max	200max	200max	200max
	TEMPERATURE REGULATION[mV]	-20 to +55°C	150max	180max	150max	180max	150max	180max	150max	180max
		-40 to +55°C	240max	290max	240max	290max	240max	290max	240max	290max
DRIFT[mV] *4	50max	60max	50max	60max	50max	60max	50max	60max		
START-UP TIME[ms]	20max (Minimum input, I _o =100%)									
OUTPUT VOLTAGE ADJUSTMENT RANGE	Fixed (TRM pin open) ±5% adjustable by external VR									
OUTPUT VOLTAGE SETTING[V] (±5%)	11.40 - 12.60	14.25 - 15.75	11.40 - 12.60	14.25 - 15.75	11.40 - 12.60	14.25 - 15.75	11.40 - 12.60	14.25 - 15.75		
PROTECTION CIRCUIT AND OTHERS	OVERCURRENT PROTECTION	Works over 105% of rating and recovers automatically								
ISOLATION	INPUT-OUTPUT	AC500V 1minute, Cutoff current = 10mA, DC500V 50MΩ min (20±15°C)								
	INPUT-CASE	AC500V 1minute, Cutoff current = 10mA, DC500V 50MΩ min (20±15°C)								
	OUTPUT-CASE	AC500V 1minute, Cutoff current = 10mA, DC500V 50MΩ min (20±15°C)								
ENVIRONMENT	OPERATING TEMP., HUMID. AND ALTITUDE	-40 to +85°C, 20 - 95%RH (Non condensing) (Refer to "Derating"), 3,000m (10,000feet) max								
	STORAGE TEMP., HUMID. AND ALTITUDE	-40 to +100°C, 20 - 95%RH (Non condensing), 9,000m (30,000feet) max								
	VIBRATION	10 - 55Hz, 98.0m/s ² (10G), 3minutes period, 60minutes each along X, Y and Z axis								
	IMPACT	490.3m/s ² (50G), 11ms, once each along X, Y and Z axis								
SAFETY	AGENCY APPROVALS	UL60950-1, C-UL, EN60950-1								
OTHERS	CASE SIZE/WEIGHT	22.4 × 7.0 × 13.2mm [0.88 × 0.28 × 0.52 inches] (W × H × D) / 3g max								
	COOLING METHOD	Convection/Forced air								

*1 Output pins can be connected in series to make a 24V/30V output.
 *2 Rated input 5V, 12V, 24V or 48V DC I_o=100%
 *3 Ripple and Ripple Noise is measured by using measuring board with capacitor with in 25mm from output pin terminals.
 *4 Drift is the change in DC output for an eight hour period after a half-hour warm-up at 25°C.
 * Parallel operation with other model is not possible.

SUCS3

SUC S 3 12 05 B P - □

① ② ③ ④ ⑤ ⑥ ⑦ ⑧

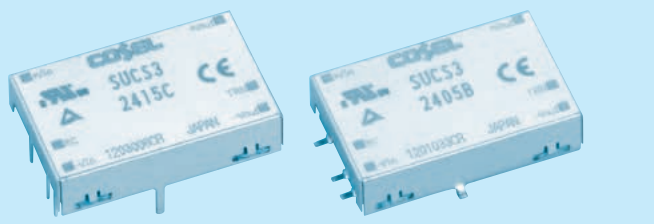
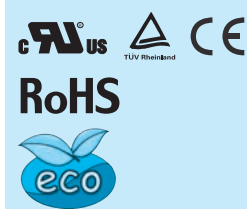

- ① Series name
- ② Single output
- ③ Output wattage
- ④ Input voltage
- ⑤ Output voltage
- ⑥ Mounting type
B :SMD
C :DIP
- ⑦ Packing form
Blank:Plastic cover
P :Tray (SMD type)
- ⑧ Optional
G :Capacitor between Input and Output is removed.
C :with coating (only DIP type)*
* Safety standards are pending

MODEL	SUCS3053R3	SUCS30505	SUCS30512	SUCS30515	SUCS3123R3	SUCS31205	SUCS31212	SUCS31215	
MAX OUTPUT WATTAGE[W]	1.98	3	3	3	1.98	3	3	3	
DC OUTPUT	VOLTAGE[V] *1	3.3	5	12	15	3.3	5	12	15
	CURRENT[A]	0.6	0.6	0.25	0.2	0.6	0.6	0.25	0.2

SPECIFICATIONS

	MODEL	SUCS3053R3	SUCS30505	SUCS30512	SUCS30515	SUCS3123R3	SUCS31205	SUCS31212	SUCS31215	
INPUT	VOLTAGE[V]	DC4.5 - 9				DC9 - 18				
	CURRENT[A] *2	0.550typ	0.800typ	0.780typ	0.780typ	0.223typ	0.325typ	0.317typ	0.321typ	
	EFFICIENCY[%] *2	72typ	75typ	77typ	77typ	74typ	77typ	79typ	78typ	
OUTPUT	VOLTAGE[V]	3.3	5	12	15	3.3	5	12	15	
	CURRENT[A]	0.6	0.6	0.25	0.2	0.6	0.6	0.25	0.2	
	LINE REGULATION[mV]	20max	20max	48max	60max	20max	20max	48max	60max	
	LOAD REGULATION[mV]	40max	40max	100max	120max	40max	40max	100max	120max	
	RIPPLE[mVp-p]	-20 to +55°C *3	80max	80max	120max	120max	80max	80max	120max	120max
		-40 to -20°C *3	120max	120max	150max	150max	120max	120max	150max	150max
	RIPPLE NOISE[mVp-p]	-20 to +55°C *3	120max	120max	150max	150max	120max	120max	150max	150max
		-40 to -20°C *3	200max	200max	200max	200max	200max	200max	200max	200max
	TEMPERATURE REGULATION[mV]	-20 to +55°C	50max	50max	150max	180max	50max	50max	150max	180max
		-40 to +55°C	80max	80max	240max	290max	80max	80max	240max	290max
	DRIFT[mV] *4	20max	20max	48max	60max	20max	20max	48max	60max	
START-UP TIME[ms]	20max (Minimum input, Io=100%)									
OUTPUT VOLTAGE ADJUSTMENT RANGE	Fixed (TRM pin open) ±5% adjustable by external VR									
OUTPUT VOLTAGE SETTING[V] (±3%)	3.21 - 3.42	4.90 - 5.21	11.64 - 12.36	14.55 - 15.45	3.21 - 3.42	4.90 - 5.21	11.64 - 12.36	14.55 - 15.45		
PROTECTION CIRCUIT AND OTHERS	OVERCURRENT PROTECTION	Works over 105% of rating and recovers automatically								
	REMOTE ON/OFF	Provided (Negative logic L : ON, H : OFF)								

MODEL	SUCS3243R3	SUCS32405	SUCS32412	SUCS32415	SUCS3483R3	SUCS34805	SUCS34812	SUCS34815	
MAX OUTPUT WATTAGE[W]	1.98	3	3	3	1.98	3	3	3	
DC OUTPUT	VOLTAGE[V] *1	3.3	5	12	15	3.3	5	12	15
	CURRENT[A]	0.6	0.6	0.25	0.2	0.6	0.6	0.25	0.2

SPECIFICATIONS

	MODEL	SUCS3243R3	SUCS32405	SUCS32412	SUCS32415	SUCS3483R3	SUCS34805	SUCS34812	SUCS34815	
INPUT	VOLTAGE[V]	DC18 - 36				DC36 - 76				
	CURRENT[A] *2	0.114typ	0.163typ	0.159typ	0.161typ	0.057typ	0.082typ	0.080typ	0.080typ	
	EFFICIENCY[%] *2	73typ	77typ	79typ	78typ	72typ	77typ	79typ	79typ	
OUTPUT	VOLTAGE[V]	3.3	5	12	15	3.3	5	12	15	
	CURRENT[A]	0.6	0.6	0.25	0.2	0.6	0.6	0.25	0.2	
	LINE REGULATION[mV]	20max	20max	48max	60max	20max	20max	48max	60max	
	LOAD REGULATION[mV]	40max	40max	100max	120max	40max	40max	100max	120max	
	RIPPLE[mVp-p]	-20 to +55°C *3	80max	80max	120max	120max	80max	80max	120max	120max
		-40 to -20°C *3	120max	120max	150max	150max	120max	120max	150max	150max
	RIPPLE NOISE[mVp-p]	-20 to +55°C *3	120max	120max	150max	150max	120max	120max	150max	150max
		-40 to -20°C *3	200max	200max	200max	200max	200max	200max	200max	200max
	TEMPERATURE REGULATION[mV]	-20 to +55°C	50max	50max	150max	180max	50max	50max	150max	180max
		-40 to +55°C	80max	80max	240max	290max	80max	80max	240max	290max
	DRIFT[mV] *4	20max	20max	48max	60max	20max	20max	48max	60max	
START-UP TIME[ms]	20max (Minimum input, Io=100%)									
OUTPUT VOLTAGE ADJUSTMENT RANGE	Fixed (TRM pin open) ±5% adjustable by external VR									
OUTPUT VOLTAGE SETTING[V] (±3%)	3.21 - 3.42	4.90 - 5.21	11.64 - 12.36	14.55 - 15.45	3.21 - 3.42	4.90 - 5.21	11.64 - 12.36	14.55 - 15.45		
PROTECTION CIRCUIT AND OTHERS	OVERCURRENT PROTECTION	Works over 105% of rating and recovers automatically								
	REMOTE ON/OFF	Provided (Negative logic L : ON, H : OFF)								

GENERAL SPECIFICATIONS

ISOLATION	INPUT-OUTPUT	AC500V 1minute, Cutoff current = 10mA, DC500V 50MΩ min (20±15°C)
	INPUT-CASE	AC500V 1minute, Cutoff current = 10mA, DC500V 50MΩ min (20±15°C)
	OUTPUT-CASE	AC500V 1minute, Cutoff current = 10mA, DC500V 50MΩ min (20±15°C)
ENVIRONMENT	OPERATING TEMP., HUMID. AND ALTITUDE	-40 to +85°C, 20 - 95%RH (Non condensing) (Refer to "Derating"), 3,000m (10,000feet) max
	STORAGE TEMP., HUMID. AND ALTITUDE	-40 to +100°C, 20 - 95%RH (Non condensing), 9,000m (30,000feet) max
	VIBRATION	10 - 55Hz, 98.0m/s ² (10G), 3minutes period, 60minutes each along X, Y and Z axis
	IMPACT	490.3m/s ² (50G), 11ms, once each along X, Y and Z axis
SAFETY	AGENCY APPROVALS	UL60950-1, C-UL, EN60950-1
OTHERS	CASE SIZE/WEIGHT	25 × 7.0 × 16.1mm [0.98 × 0.28 × 0.63 inches] (W×H×D) / 5g max
	COOLING METHOD	Convection/Forced air

- *1 SUCW3xx12/SUCW3xx15 is available as single output, +24V/+30V.
- *2 Rated input 5V, 12V, 24V or 48V DC I_o=100%
- *3 Ripple and Ripple Noise is measured by using measuring board with capacitor with in 25mm from output pin terminals.
- *4 Drift is the change in DC output for an eight hour period after a half-hour warm-up at 25°C.
- * Parallel operation with other model is not possible.

External view

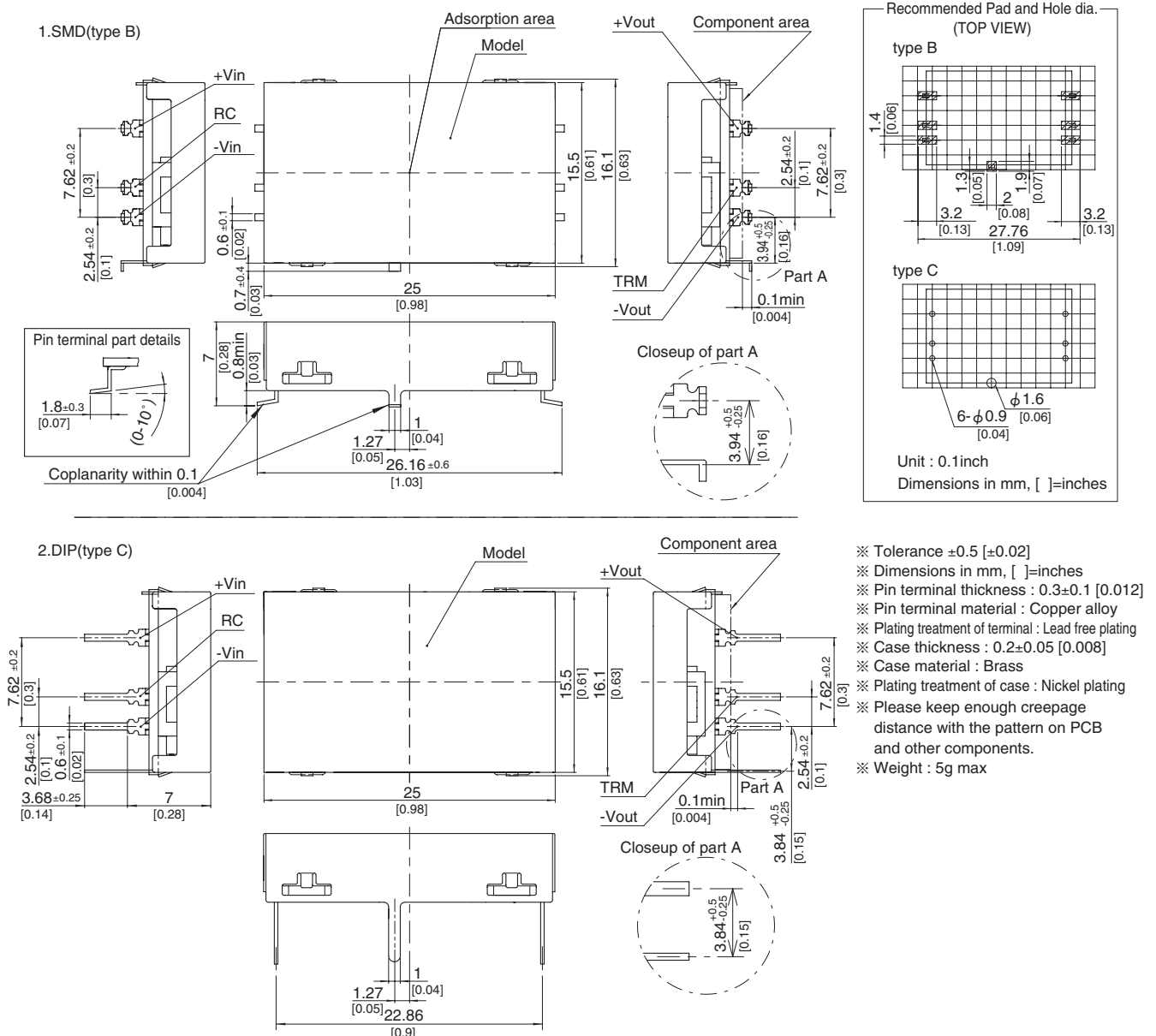

SUCW3

SUC W 3 12 12 B P - □
 ① ② ③ ④ ⑤ ⑥ ⑦ ⑧

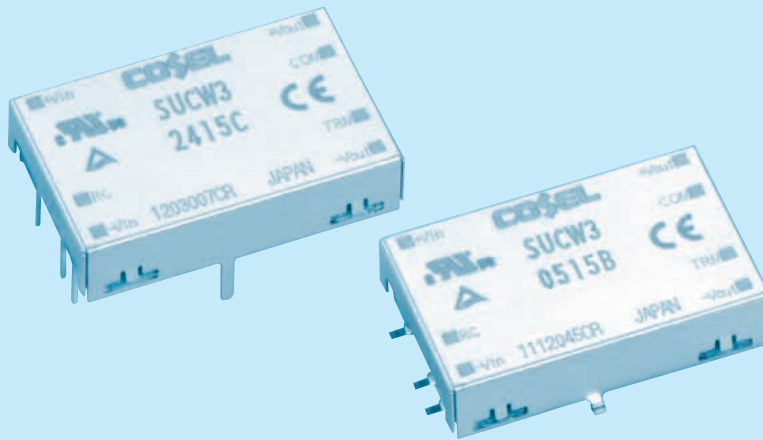
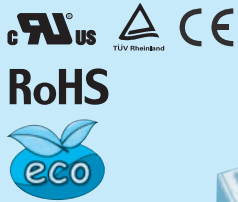

- ① Series name
 - ② Dual output
 - ③ Output wattage
 - ④ Input voltage
 - ⑤ Output voltage
 - ⑥ Mounting type
B : SMD
C : DIP
 - ⑦ Packing form
Blank: Plastic cover
P : Tray (SMD type)
 - ⑧ Optional
G : Capacitor between Input and Output is removed.
C : with coating (only DIP type)*
- * Safety standards are pending

MODEL	SUCW30512	SUCW30515	SUCW31212	SUCW31215	SUCW32412	SUCW32415	SUCW34812	SUCW34815	
MAX OUTPUT WATTAGE[W]	3.12	3	3.12	3	3.12	3	3.12	3	
DC OUTPUT	VOLTAGE[V]*1	±12 or +24	±15 or +30	±12 or +24	±15 or +30	±12 or +24	±15 or +30	±12 or +24	±15 or +30
	CURRENT[A]	0.13	0.1	0.13	0.1	0.13	0.1	0.13	0.1

SPECIFICATIONS

	MODEL	SUCW30512	SUCW30515	SUCW31212	SUCW31215	SUCW32412	SUCW32415	SUCW34812	SUCW34815	
INPUT	VOLTAGE[V]	DC4.5 - 9		DC9 - 18		DC18 - 36		DC36 - 76		
	CURRENT[A]	*2 0.844typ	0.811typ	0.343typ	0.329typ	0.172typ	0.165typ	0.086typ	0.083typ	
	EFFICIENCY[%]	*2 74typ	74typ	76typ	76typ	76typ	76typ	76typ	76typ	
OUTPUT	VOLTAGE[V]	±12(+24)	±15(+30)	±12(+24)	±15(+30)	±12(+24)	±15(+30)	±12(+24)	±15(+30)	
	CURRENT[A]	0.13	0.1	0.13	0.1	0.13	0.1	0.13	0.1	
	LINE REGULATION[mV]	60max	75max	60max	75max	60max	75max	60max	75max	
	LOAD REGULATION[mV]	600max	750max	600max	750max	600max	750max	600max	750max	
	RIPPLE[mVp-p]	-20 to +55°C *3	120max	120max	120max	120max	120max	120max	120max	120max
		-40 to -20°C *3	150max	150max	150max	150max	150max	150max	150max	150max
	RIPPLE NOISE[mVp-p]	-20 to +55°C *3	150max	150max	150max	150max	150max	150max	150max	150max
		-40 to -20°C *3	200max	200max	200max	200max	200max	200max	200max	200max
	TEMPERATURE REGULATION[mV]	-20 to +55°C	150max	180max	150max	180max	150max	180max	150max	180max
		-40 to +55°C	240max	290max	240max	290max	240max	290max	240max	290max
DRIFT[mV]	*4 50max	60max	50max	60max	50max	60max	50max	60max		
START-UP TIME[ms]	20max (Minimum input, Io=100%)									
OUTPUT VOLTAGE ADJUSTMENT RANGE	Fixed (TRM pin open) ±5% adjustable by external VR									
OUTPUT VOLTAGE SETTING[V] (±5%)	11.40 - 12.60	14.25 - 15.75	11.40 - 12.60	14.25 - 15.75	11.40 - 12.60	14.25 - 15.75	11.40 - 12.60	14.25 - 15.75		
PROTECTION CIRCUIT AND OTHERS	OVERCURRENT PROTECTION	Works over 105% of rating and recovers automatically								
	REMOTE ON/OFF	Provided (Negative logic L : ON, H : OFF)								
ISOLATION	INPUT-OUTPUT	AC500V 1minute, Cutoff current = 10mA, DC500V 50MΩ min (20±15°C)								
	INPUT-CASE	AC500V 1minute, Cutoff current = 10mA, DC500V 50MΩ min (20±15°C)								
	OUTPUT-CASE	AC500V 1minute, Cutoff current = 10mA, DC500V 50MΩ min (20±15°C)								
ENVIRONMENT	OPERATING TEMP., HUMID. AND ALTITUDE	-40 to +85°C, 20 - 95%RH (Non condensing) (Refer to "Derating"), 3,000m (10,000feet) max								
	STORAGE TEMP., HUMID. AND ALTITUDE	-40 to +100°C, 20 - 95%RH (Non condensing), 9,000m (30,000feet) max								
	VIBRATION	10 - 55Hz, 98.0m/s ² (10G), 3minutes period, 60minutes each along X, Y and Z axis								
	IMPACT	490.3m/s ² (50G), 11ms, once each along X, Y and Z axis								
SAFETY	AGENCY APPROVALS	UL60950-1, C-UL, EN60950-1								
OTHERS	CASE SIZE/WEIGHT	25 × 7.0 × 16.1mm [0.98 × 0.28 × 0.63 inches] (W × H × D) / 5g max								
	COOLING METHOD	Convection/Forced air								

*1 Output pins can be connected in series to make a 24V/30V output.
 *2 Rated input 5V, 12V, 24V or 48V DC Io=100%
 *3 Ripple and Ripple Noise is measured by using measuring board with capacitor with in 25mm from output pin terminals.
 *4 Drift is the change in DC output for an eight hour period after a half-hour warm-up at 25°C.
 * Parallel operation with other model is not possible.

External view

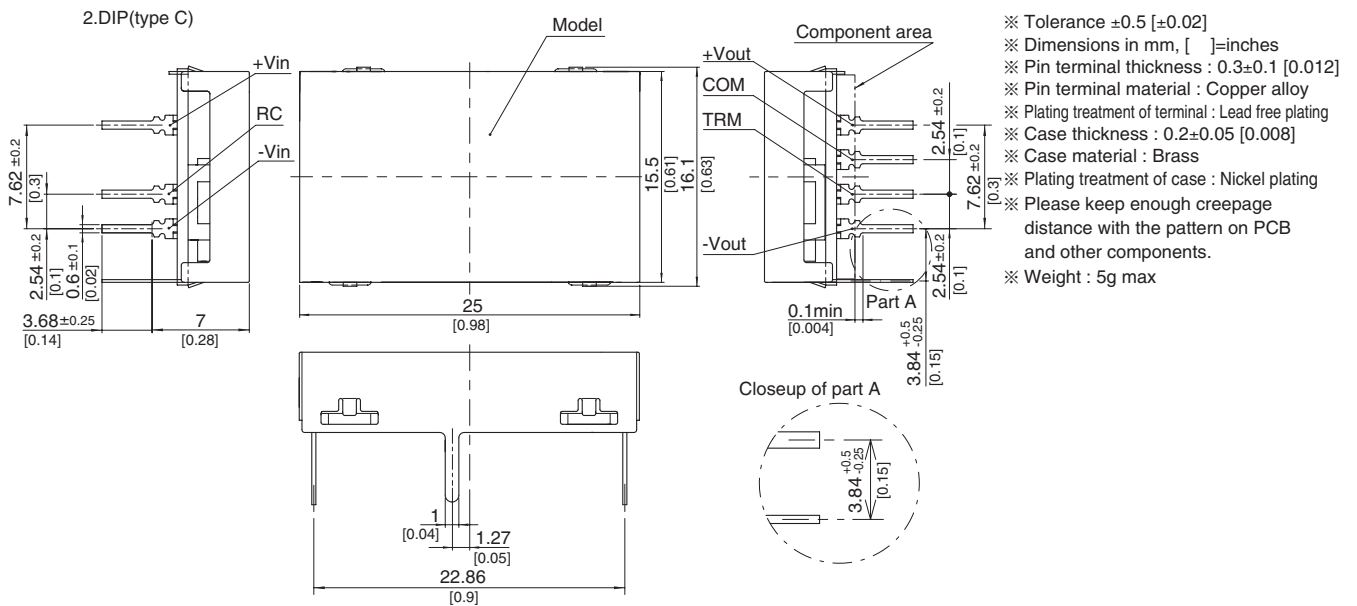
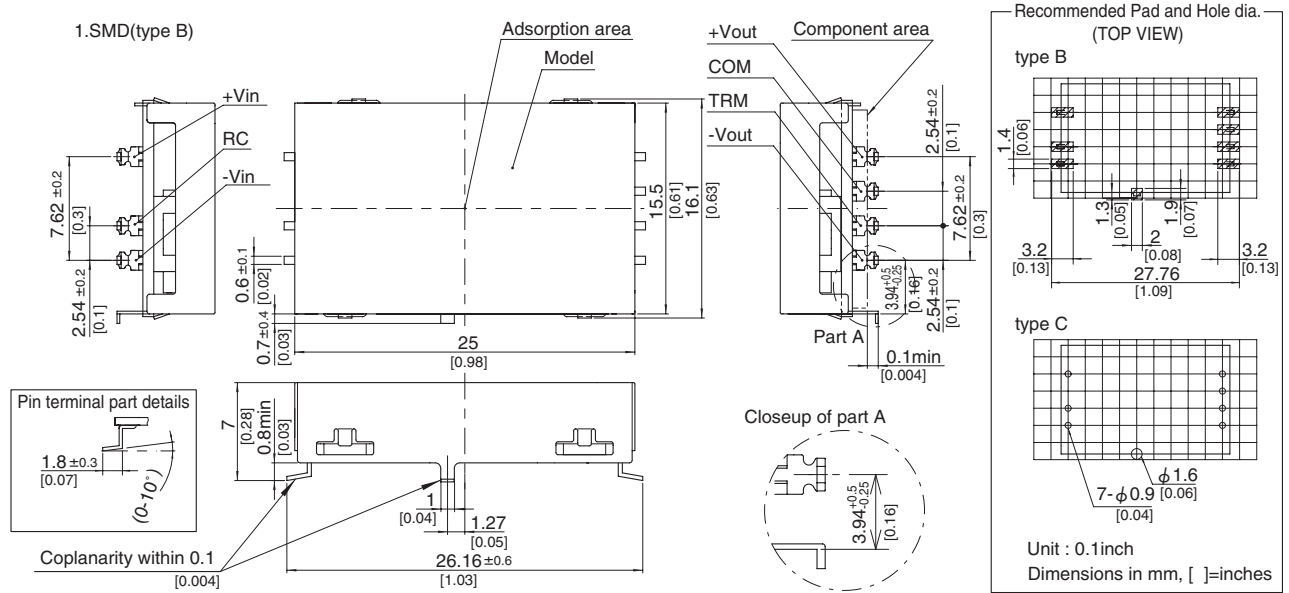

SUCS6

SUC S 6 12 05 B P - □

① ② ③ ④ ⑤ ⑥ ⑦ ⑧

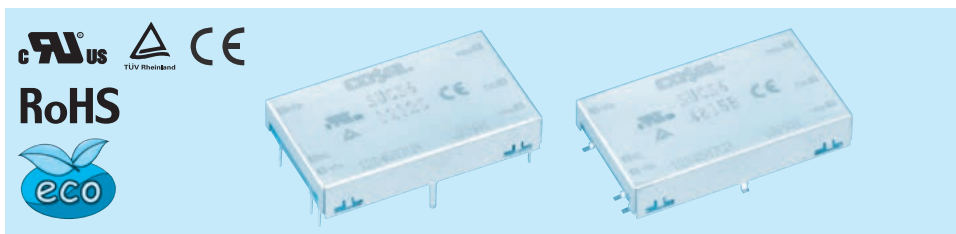

- ① Series name
- ② Single output
- ③ Output wattage
- ④ Input voltage
- ⑤ Output voltage
- ⑥ Mounting type
B :SMD
C :DIP
- ⑦ Packing form
Blank:Plastic cover
P :Tray (SMD type)
- ⑧ Optional
G :Capacitor between Input and Output is removed.
C :with coating (only DIP type)*
* Safety standards are pending

MODEL	SUCS6053R3	SUCS60505	SUCS60512	SUCS60515	SUCS6123R3	SUCS61205	SUCS61212	SUCS61215	
MAX OUTPUT WATTAGE[W]	3.96	5	6	6	4.46	6	6	6	
DC OUTPUT	VOLTAGE[V] *1	3.3	5	12	15	3.3	5	12	15
	CURRENT[A]	1.2	1	0.5	0.4	1.35	1.2	0.5	0.4

SPECIFICATIONS

	MODEL	SUCS6053R3	SUCS60505	SUCS60512	SUCS60515	SUCS6123R3	SUCS61205	SUCS61212	SUCS61215	
INPUT	VOLTAGE[V]	DC4.5 - 9				DC9 - 18				
	CURRENT[A] *2	1.100typ	1.316typ	1.500typ	1.500typ	0.502typ	0.617typ	0.588typ	0.588typ	
	EFFICIENCY[%] *2	72typ	76typ	80typ	80typ	74typ	81typ	85typ	85typ	
OUTPUT	VOLTAGE[V]	3.3	5	12	15	3.3	5	12	15	
	CURRENT[A]	1.2	1	0.5	0.4	1.35	1.2	0.5	0.4	
	LINE REGULATION[mV]	20max	20max	48max	60max	20max	20max	48max	60max	
	LOAD REGULATION[mV]	40max	40max	100max	120max	40max	40max	100max	120max	
	RIPPLE[mVp-p]	-20 to +55°C *3	80max	80max	120max	120max	80max	80max	120max	120max
		-40 to -20°C *3	120max	120max	150max	150max	120max	120max	150max	150max
	RIPPLE NOISE[mVp-p]	-20 to +55°C *3	120max	120max	150max	150max	120max	120max	150max	150max
		-40 to -20°C *3	200max	200max	200max	200max	200max	200max	200max	200max
	TEMPERATURE REGULATION[mV]	-20 to +55°C	50max	50max	150max	180max	50max	50max	150max	180max
		-40 to +55°C	80max	80max	240max	290max	80max	80max	240max	290max
DRIFT[mV] *4	20max	20max	48max	60max	20max	20max	48max	60max		
START-UP TIME[ms]	20max (Minimum input, Io=100%)									
OUTPUT VOLTAGE ADJUSTMENT RANGE	Fixed (TRM pin open) ±5% adjustable by external VR									
OUTPUT VOLTAGE SETTING[V] (±3%)	3.21 - 3.42	4.90 - 5.21	11.64 - 12.36	14.55 - 15.45	3.21 - 3.42	4.90 - 5.21	11.64 - 12.36	14.55 - 15.45		
PROTECTION CIRCUIT AND OTHERS	OVERCURRENT PROTECTION	Works over 105% of rating and recovers automatically								
	REMOTE ON/OFF	Provided (Negative logic L : ON, H : OFF)								

MODEL	SUCS6243R3	SUCS62405	SUCS62412	SUCS62415	SUCS6483R3	SUCS64805	SUCS64812	SUCS64815	
MAX OUTPUT WATTAGE[W]	4.46	6	6	6	4.46	6	6	6	
DC OUTPUT	VOLTAGE[V] *1	3.3	5	12	15	3.3	5	12	15
	CURRENT[A]	1.35	1.2	0.5	0.4	1.35	1.2	0.5	0.4

SPECIFICATIONS

	MODEL	SUCS6243R3	SUCS62405	SUCS62412	SUCS62415	SUCS6483R3	SUCS64805	SUCS64812	SUCS64815	
INPUT	VOLTAGE[V]	DC18 - 36				DC36 - 76				
	CURRENT[A] *2	0.248typ	0.309typ	0.291typ	0.291typ	0.121typ	0.154typ	0.145typ	0.145typ	
	EFFICIENCY[%] *2	75typ	81typ	86typ	86typ	77typ	81typ	86typ	86typ	
OUTPUT	VOLTAGE[V]	3.3	5	12	15	3.3	5	12	15	
	CURRENT[A]	1.35	1.2	0.5	0.4	1.35	1.2	0.5	0.4	
	LINE REGULATION[mV]	20max	20max	48max	60max	20max	20max	48max	60max	
	LOAD REGULATION[mV]	40max	40max	100max	120max	40max	40max	100max	120max	
	RIPPLE[mVp-p]	-20 to +55°C *3	80max	80max	120max	120max	80max	80max	120max	120max
		-40 to -20°C *3	120max	120max	150max	150max	120max	120max	150max	150max
	RIPPLE NOISE[mVp-p]	-20 to +55°C *3	120max	120max	150max	150max	120max	120max	150max	150max
		-40 to -20°C *3	200max	200max	200max	200max	200max	200max	200max	200max
	TEMPERATURE REGULATION[mV]	-20 to +55°C	50max	50max	150max	180max	50max	50max	150max	180max
		-40 to +55°C	80max	80max	240max	290max	80max	80max	240max	290max
DRIFT[mV] *4	20max	20max	48max	60max	20max	20max	48max	60max		
START-UP TIME[ms]	20max (Minimum input, Io=100%)									
OUTPUT VOLTAGE ADJUSTMENT RANGE	Fixed (TRM pin open) ±5% adjustable by external VR									
OUTPUT VOLTAGE SETTING[V] (±3%)	3.21 - 3.42	4.90 - 5.21	11.64 - 12.36	14.55 - 15.45	3.21 - 3.42	4.90 - 5.21	11.64 - 12.36	14.55 - 15.45		
PROTECTION CIRCUIT AND OTHERS	OVERCURRENT PROTECTION	Works over 105% of rating and recovers automatically								
	REMOTE ON/OFF	Provided (Negative logic L : ON, H : OFF)								

GENERAL SPECIFICATIONS

ISOLATION	INPUT-OUTPUT	AC500V 1minute, Cutoff current = 10mA, DC500V 50M Ω min (20 \pm 15 $^{\circ}$ C)
	INPUT-CASE	AC500V 1minute, Cutoff current = 10mA, DC500V 50M Ω min (20 \pm 15 $^{\circ}$ C)
	OUTPUT-CASE	AC500V 1minute, Cutoff current = 10mA, DC500V 50M Ω min (20 \pm 15 $^{\circ}$ C)
ENVIRONMENT	OPERATING TEMP., HUMID. AND ALTITUDE	-40 to +85 $^{\circ}$ C, 20 - 95%RH (Non condensing) (Refer to "Derating"), 3,000m (10,000feet) max
	STORAGE TEMP., HUMID. AND ALTITUDE	-40 to +100 $^{\circ}$ C, 20 - 95%RH (Non condensing), 9,000m (30,000feet) max
	VIBRATION	10 - 55Hz, 98.0m/s ² (10G), 3minutes period, 60minutes each along X, Y and Z axis
	IMPACT	490.3m/s ² (50G), 11ms, once each along X, Y and Z axis
SAFETY	AGENCY APPROVALS	UL60950-1, C-UL, EN60950-1
OTHERS	CASE SIZE/WEIGHT	32.6 x 7.0 x 19.1mm [1.28 x 0.28 x 0.75 inches] (W x H x D) / 7g max
	COOLING METHOD	Convection/Forced air

- *1 SUCW6xx12/SUCW6xx15 is available as single output, +24V/+30V.
- *2 Rated input 5V, 12V, 24V or 48V DC I_o=100%
- *3 Ripple and Ripple Noise is measured by using measuring board with capacitor with in 25mm from output pin terminals.
- *4 Drift is the change in DC output for an eight hour period after a half-hour warm-up at 25 $^{\circ}$ C.
- * Parallel operation with other model is not possible.

External view

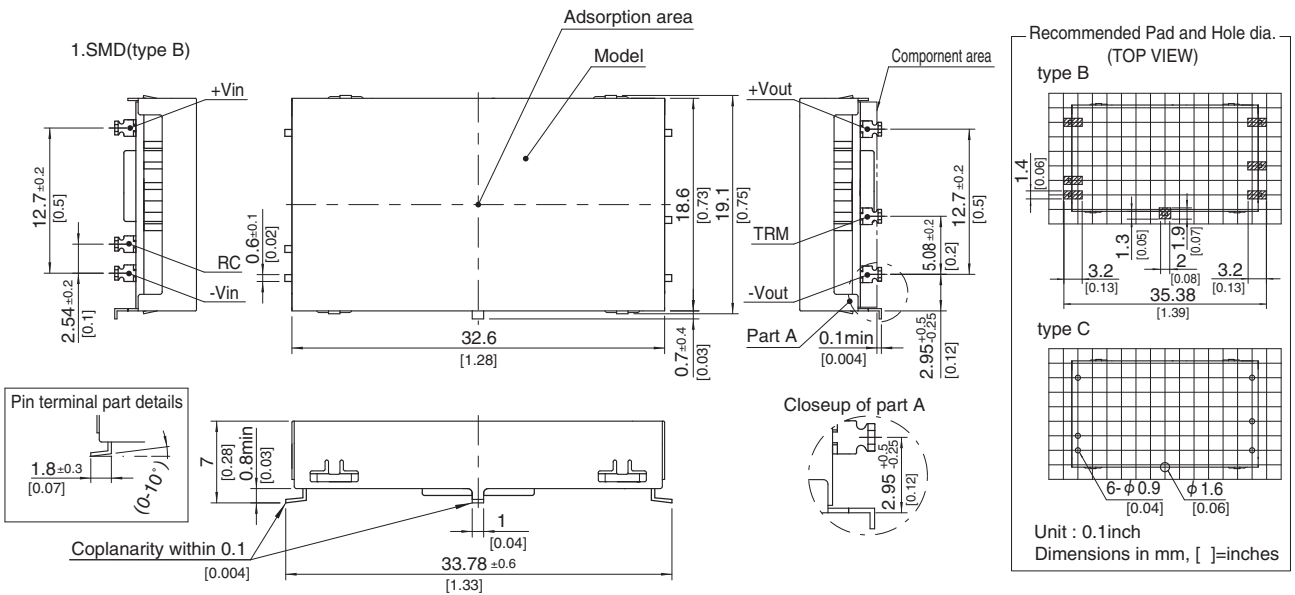

- ※ Tolerance \pm 0.5 [\pm 0.02]
- ※ Dimensions in mm, []=inches
- ※ Pin terminal thickness : 0.3 \pm 0.1 [0.012]
- ※ Pin terminal material : Copper alloy
- ※ Plating treatment of terminal : Lead free plating
- ※ Case thickness : 0.2 \pm 0.05 [0.008]
- ※ Case material : Brass
- ※ Plating treatment of case : Nickel plating
- ※ Please keep enough creepage distance with the pattern on PCB and other components.
- ※ Weight : 7g max

SUCW6

SUC W 6 12 12 B P - □

① ② ③ ④ ⑤ ⑥ ⑦ ⑧

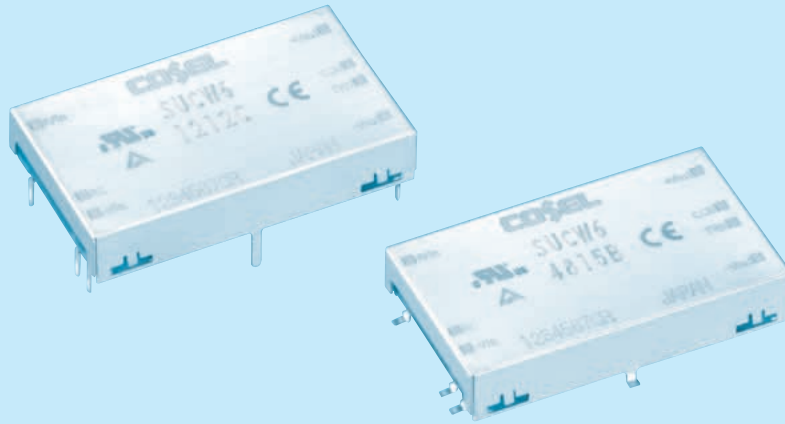

- ① Series name
 - ② Dual output
 - ③ Output wattage
 - ④ Input voltage
 - ⑤ Output voltage
 - ⑥ Mounting type
B : SMD
C : DIP
 - ⑦ Packing form
Blank: Plastic cover
P : Tray (SMD type)
 - ⑧ Optional
G : Capacitor between Input and Output is removed.
C : with coating (only DIP type)*
- * Safety standards are pending

MODEL	SUCW60512	SUCW60515	SUCW61212	SUCW61215	SUCW62412	SUCW62415	SUCW64812	SUCW64815
MAX OUTPUT WATTAGE[W]	6	6	6	6	6	6	6	6
DC OUTPUT	VOLTAGE[V]*1	±12 or +24	±15 or +30	±12 or +24	±15 or +30	±12 or +24	±12 or +24	±15 or +30
	CURRENT[A]	0.25	0.2	0.25	0.2	0.25	0.25	0.2

SPECIFICATIONS

	MODEL	SUCW60512	SUCW60515	SUCW61212	SUCW61215	SUCW62412	SUCW62415	SUCW64812	SUCW64815	
INPUT	VOLTAGE[V]	DC4.5 - 9		DC9 - 18		DC18 - 36		DC36 - 76		
	CURRENT[A]	*2 1.538typ	1.538typ	0.588typ	0.588typ	0.291typ	0.291typ	0.145typ	0.145typ	
	EFFICIENCY[%]	*2 78typ	78typ	85typ	85typ	86typ	86typ	86typ	86typ	
OUTPUT	VOLTAGE[V]	±12(+24)	±15(+30)	±12(+24)	±15(+30)	±12(+24)	±15(+30)	±12(+24)	±15(+30)	
	CURRENT[A]	0.25	0.2	0.25	0.2	0.25	0.2	0.25	0.2	
	LINE REGULATION[mV]	60max	75max	60max	75max	60max	75max	60max	75max	
	LOAD REGULATION[mV]	600max	750max	600max	750max	600max	750max	600max	750max	
	RIPPLE[mVp-p]	-20 to +55°C *3	120max	120max	120max	120max	120max	120max	120max	120max
		-40 to -20°C *3	150max	150max	150max	150max	150max	150max	150max	150max
	RIPPLE NOISE[mVp-p]	-20 to +55°C *3	150max	150max	150max	150max	150max	150max	150max	150max
		-40 to -20°C *3	200max	200max	200max	200max	200max	200max	200max	200max
	TEMPERATURE REGULATION[mV]	-20 to +55°C	150max	180max	150max	180max	150max	180max	150max	180max
		-40 to +55°C	240max	290max	240max	290max	240max	290max	240max	290max
DRIFT[mV]	*4	50max	60max	50max	60max	50max	60max	50max	60max	
START-UP TIME[ms]		20max (Minimum input, Io=100%)								
OUTPUT VOLTAGE ADJUSTMENT RANGE		Fixed (TRM pin open) ±5% adjustable by external VR								
OUTPUT VOLTAGE SETTING[V] (±5%)		11.40 - 12.60	14.25 - 15.75	11.40 - 12.60	14.25 - 15.75	11.40 - 12.60	14.25 - 15.75	11.40 - 12.60	14.25 - 15.75	
PROTECTION CIRCUIT AND OTHERS	OVERCURRENT PROTECTION	Works over 105% of rating and recovers automatically								
	REMOTE ON/OFF	Provided (Negative logic L : ON, H : OFF)								
ISOLATION	INPUT-OUTPUT	AC500V 1minute, Cutoff current = 10mA, DC500V 50MΩ min (20±15°C)								
	INPUT-CASE	AC500V 1minute, Cutoff current = 10mA, DC500V 50MΩ min (20±15°C)								
	OUTPUT-CASE	AC500V 1minute, Cutoff current = 10mA, DC500V 50MΩ min (20±15°C)								
ENVIRONMENT	OPERATING TEMP., HUMID. AND ALTITUDE	-40 to +85°C, 20 - 95%RH (Non condensing) (Refer to "Derating"), 3,000m (10,000feet) max								
	STORAGE TEMP., HUMID. AND ALTITUDE	-40 to +100°C, 20 - 95%RH (Non condensing), 9,000m (30,000feet) max								
	VIBRATION	10 - 55Hz, 98.0m/s ² (10G), 3minutes period, 60minutes each along X, Y and Z axis								
	IMPACT	490.3m/s ² (50G), 11ms, once each along X, Y and Z axis								
SAFETY	AGENCY APPROVALS	UL60950-1, C-UL, EN60950-1								
OTHERS	CASE SIZE/WEIGHT	32.6 × 7.0 × 19.1mm [1.28 × 0.28 × 0.75 inches] (W × H × D) / 7g max								
	COOLING METHOD	Convection/Forced air								

*1 Output pins can be connected in series to make a 24V/30V output.
 *2 Rated input 5V, 12V, 24V or 48V DC Io=100%
 *3 Ripple and Ripple Noise is measured by using measuring board with capacitor with in 25mm from output pin terminals.
 *4 Drift is the change in DC output for an eight hour period after a half-hour warm-up at 25°C.
 * Parallel operation with other model is not possible.

External view

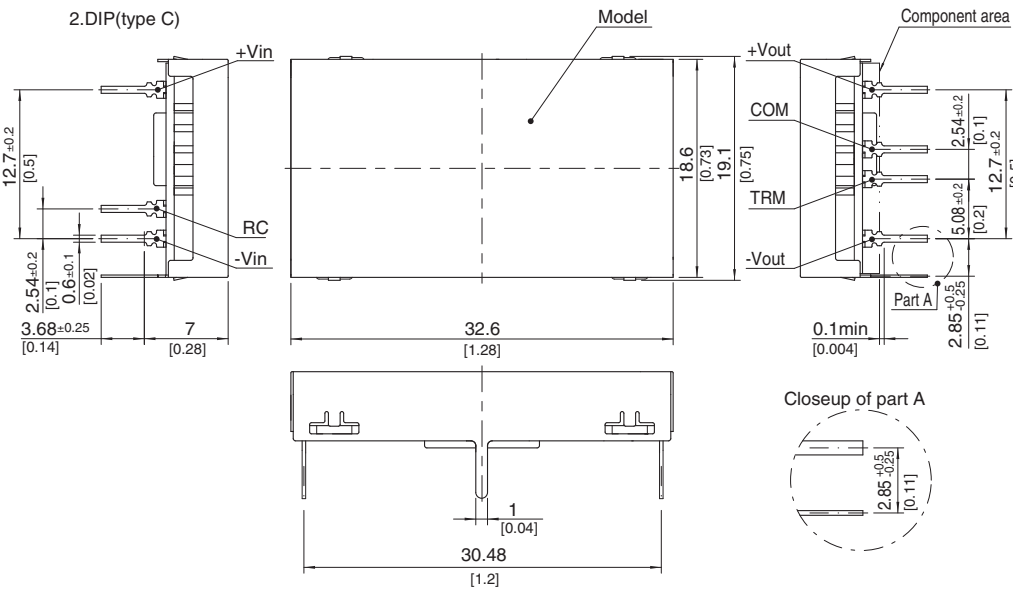
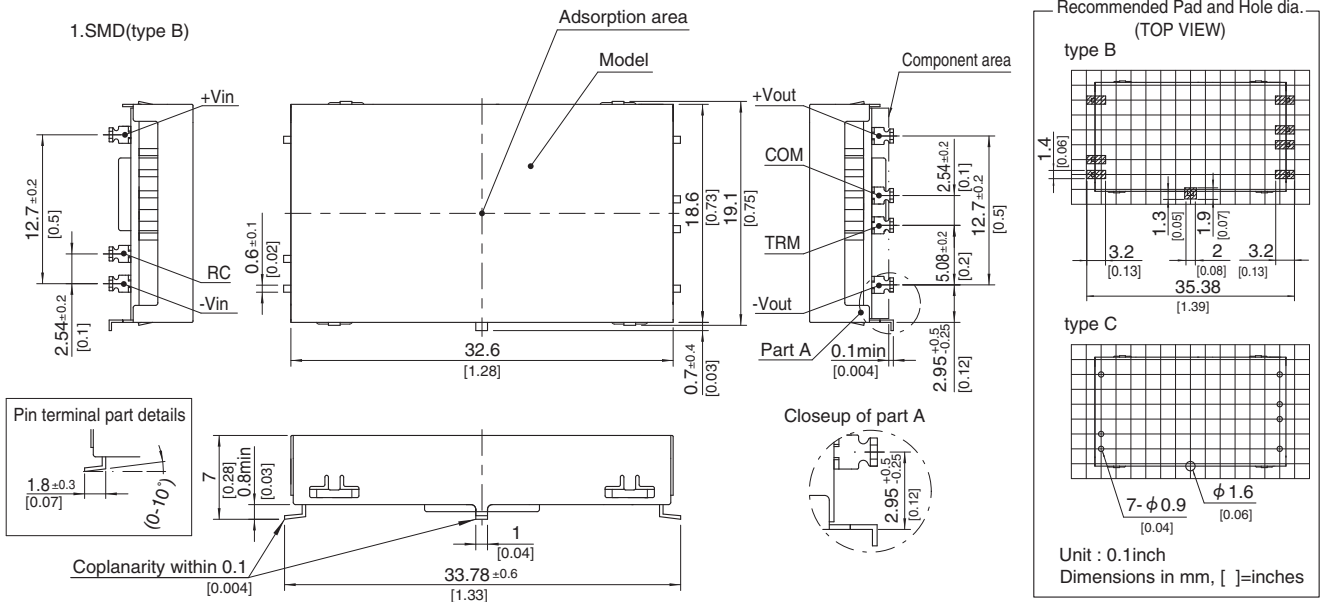

- ※ Tolerance ±0.5 [±0.02]
- ※ Dimensions in mm, []=inches
- ※ Pin terminal thickness : 0.3±0.1 [0.012]
- ※ Pin terminal material : Copper alloy
- ※ Plating treatment of terminal : Lead free plating
- ※ Case thickness : 0.2±0.05 [0.008]
- ※ Case material : Brass
- ※ Plating treatment of case : Nickel plating
- ※ Please keep enough creepage distance with the pattern on PCB and other components.
- ※ Weight : 7g max

SUCS10

SUC S 10 12 05 B P - □

① ② ③ ④ ⑤ ⑥ ⑦ ⑧



- ① Series name
- ② Single output
- ③ Output wattage
- ④ Input voltage
- ⑤ Output voltage
- ⑥ Mounting type
B :SMD
C :DIP
- ⑦ Packing form
Blank:Plastic cover
P :Tray (SMD type)
- ⑧ Optional
G :Capacitor between Input and Output is removed.
C :with coating (only DIP type)*
* Safety standards are pending

MODEL	SUCS10053R3	SUCS100505	SUCS100512	SUCS100515	SUCS10123R3	SUCS101205	SUCS101212	SUCS101215
MAX OUTPUT WATTAGE[W]	8.58	10	10.8	10.5	8.58	10	12	12
DC OUTPUT	VOLTAGE[V] *1	3.3	5	12	15	3.3	5	12
	CURRENT[A]	2.6	2	0.9	0.7	2.6	2	0.8

SPECIFICATIONS

	MODEL	SUCS10053R3	SUCS100505	SUCS100512	SUCS100515	SUCS10123R3	SUCS101205	SUCS101212	SUCS101215	
INPUT	VOLTAGE[V]	DC4.5 - 9				DC9 - 18				
	CURRENT[A] *2	2.12typ	2.41typ	2.54typ	2.47typ	0.872typ	0.980typ	1.15typ	1.15typ	
	EFFICIENCY[%] *2	81typ	83typ	85typ	85typ	82typ	85typ	87typ	87typ	
OUTPUT	VOLTAGE[V]	3.3	5	12	15	3.3	5	12	15	
	CURRENT[A]	2.6	2	0.9	0.7	2.6	2	1	0.8	
	LINE REGULATION[mV]	20max	20max	48max	60max	20max	20max	48max	60max	
	LOAD REGULATION[mV]	40max	40max	100max	120max	40max	40max	100max	120max	
	RIPPLE[mVp-p]	-20 to +55°C *3	80max	80max	120max	120max	80max	80max	120max	120max
		-40 to -20°C *3	120max	120max	150max	150max	120max	120max	150max	150max
	RIPPLE NOISE[mVp-p]	-20 to +55°C *3	120max	120max	150max	150max	120max	120max	150max	150max
		-40 to -20°C *3	200max	200max	200max	200max	200max	200max	200max	200max
	TEMPERATURE REGULATION[mV]	-20 to +55°C	50max	50max	150max	180max	50max	50max	150max	180max
		-40 to +55°C	80max	80max	240max	290max	80max	80max	240max	290max
DRIFT[mV] *4	20max	20max	48max	60max	20max	20max	48max	60max		
START-UP TIME[ms]	20max (Minimum input, Io=100%)									
OUTPUT VOLTAGE ADJUSTMENT RANGE	Fixed (TRM pin open) ±5% adjustable by external VR									
OUTPUT VOLTAGE SETTING[V] (±3%)	3.21 - 3.42	4.90 - 5.21	11.64 - 12.36	14.55 - 15.45	3.21 - 3.42	4.90 - 5.21	11.64 - 12.36	14.55 - 15.45		
PROTECTION CIRCUIT AND OTHERS	OVERCURRENT PROTECTION	Works over 105% of rating and recovers automatically								
	REMOTE ON/OFF	Provided (Negative logic L : ON, H : OFF)								

MODEL	SUCS10243R3	SUCS102405	SUCS102412	SUCS102415	SUCS10483R3	SUCS104805	SUCS104812	SUCS104815
MAX OUTPUT WATTAGE[W]	8.58	10	12	12	8.58	10	12	12
DC OUTPUT	VOLTAGE[V] *1	3.3	5	12	15	3.3	5	12
	CURRENT[A]	2.6	2	1	0.8	2.6	2	1

SPECIFICATIONS

	MODEL	SUCS10243R3	SUCS102405	SUCS102412	SUCS102415	SUCS10483R3	SUCS104805	SUCS104812	SUCS104815	
INPUT	VOLTAGE[V]	DC18 - 36				DC36 - 76				
	CURRENT[A] *2	0.436typ	0.490typ	0.575typ	0.575typ	0.218typ	0.245typ	0.287typ	0.287typ	
	EFFICIENCY[%] *2	82typ	85typ	87typ	87typ	82typ	85typ	87typ	87typ	
OUTPUT	VOLTAGE[V]	3.3	5	12	15	3.3	5	12	15	
	CURRENT[A]	2.6	2	1	0.8	2.6	2	1	0.8	
	LINE REGULATION[mV]	20max	20max	48max	60max	20max	20max	48max	60max	
	LOAD REGULATION[mV]	40max	40max	100max	120max	40max	40max	100max	120max	
	RIPPLE[mVp-p]	-20 to +55°C *3	80max	80max	120max	120max	80max	80max	120max	120max
		-40 to -20°C *3	120max	120max	150max	150max	120max	120max	150max	150max
	RIPPLE NOISE[mVp-p]	-20 to +55°C *3	120max	120max	150max	150max	120max	120max	150max	150max
		-40 to -20°C *3	200max	200max	200max	200max	200max	200max	200max	200max
	TEMPERATURE REGULATION[mV]	-20 to +55°C	50max	50max	150max	180max	50max	50max	150max	180max
		-40 to +55°C	80max	80max	240max	290max	80max	80max	240max	290max
DRIFT[mV] *4	20max	20max	48max	60max	20max	20max	48max	60max		
START-UP TIME[ms]	20max (Minimum input, Io=100%)									
OUTPUT VOLTAGE ADJUSTMENT RANGE	Fixed (TRM pin open) ±5% adjustable by external VR									
OUTPUT VOLTAGE SETTING[V] (±3%)	3.21 - 3.42	4.90 - 5.21	11.64 - 12.36	14.55 - 15.45	3.21 - 3.42	4.90 - 5.21	11.64 - 12.36	14.55 - 15.45		
PROTECTION CIRCUIT AND OTHERS	OVERCURRENT PROTECTION	Works over 105% of rating and recovers automatically								
	REMOTE ON/OFF	Provided (Negative logic L : ON, H : OFF)								

GENERAL SPECIFICATIONS

ISOLATION	INPUT-OUTPUT	AC500V 1minute, Cutoff current = 10mA, DC500V 50M Ω min (20 \pm 15 $^{\circ}$ C)
	INPUT-CASE	AC500V 1minute, Cutoff current = 10mA, DC500V 50M Ω min (20 \pm 15 $^{\circ}$ C)
	OUTPUT-CASE	AC500V 1minute, Cutoff current = 10mA, DC500V 50M Ω min (20 \pm 15 $^{\circ}$ C)
ENVIRONMENT	OPERATING TEMP., HUMID. AND ALTITUDE	-40 to +85 $^{\circ}$ C, 20 - 95%RH (Non condensing) (Refer to "Derating"), 3,000m (10,000feet) max
	STORAGE TEMP., HUMID. AND ALTITUDE	-40 to +100 $^{\circ}$ C, 20 - 95%RH (Non condensing), 9,000m (30,000feet) max
	VIBRATION	10 - 55Hz, 98.0m/s ² (10G), 3minutes period, 60minutes each along X, Y and Z axis
	IMPACT	490.3m/s ² (50G), 11ms, once each along X, Y and Z axis
SAFETY	AGENCY APPROVALS	UL60950-1, C-UL, EN60950-1
OTHERS	CASE SIZE/WEIGHT	40.2 x 7.0 x 22.0mm [1.58 x 0.28 x 0.87 inches] (W x H x D) / 10g max
	COOLING METHOD	Convection/Forced air

- *1 SUCW10xx12/SUCW10xx15 is available as single output, +24V/+30V.
- *2 Rated input 5V, 12V, 24V or 48V DC I_o=100%
- *3 Ripple and Ripple Noise is measured by using measuring board with capacitor with in 25mm from output pin terminals.
- *4 Drift is the change in DC output for an eight hour period after a half-hour warm-up at 25 $^{\circ}$ C.
- * Parallel operation with other model is not possible.

External view

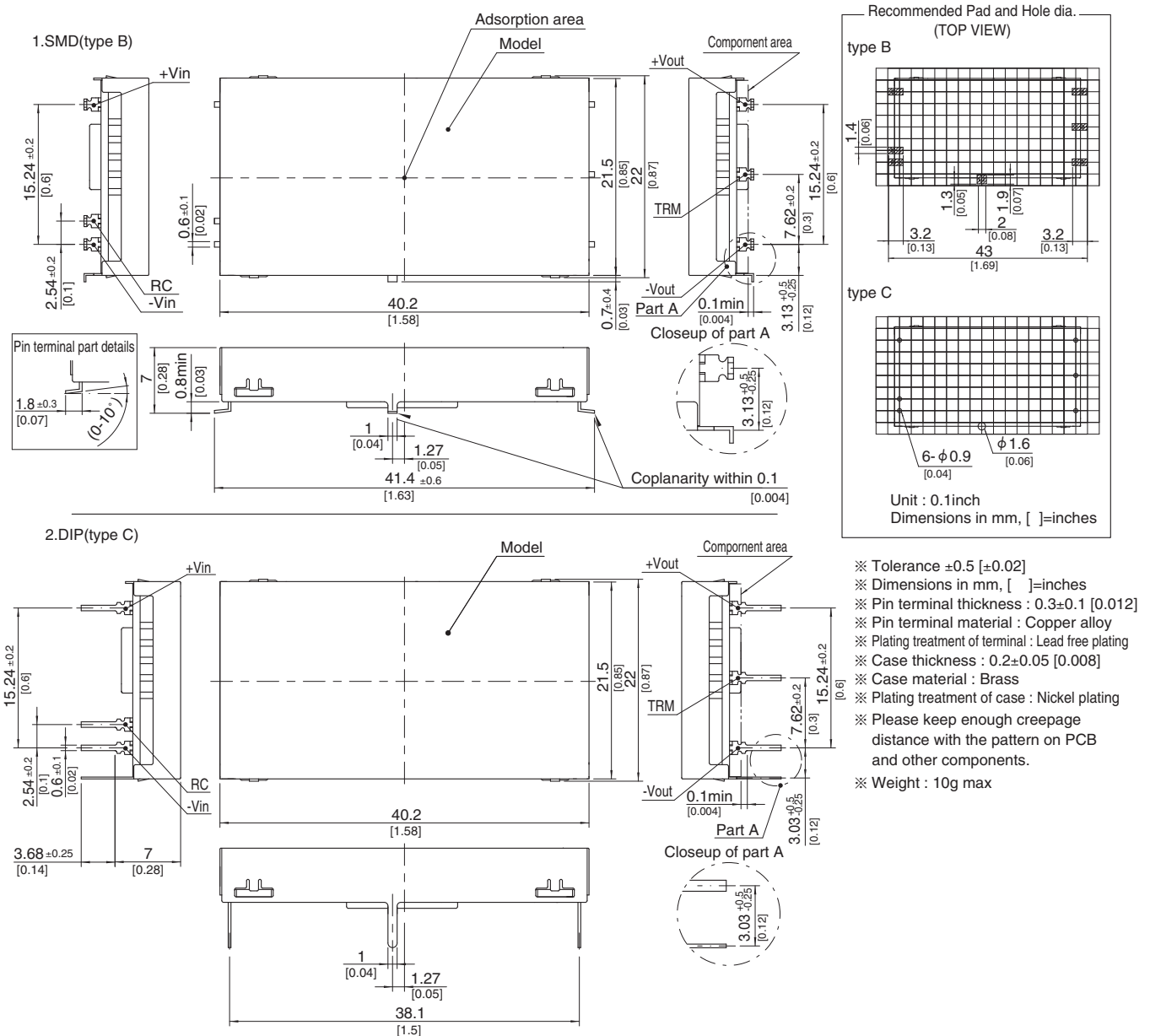

SUCW10

SUC W 10 12 12 B P - □

① ② ③ ④ ⑤ ⑥ ⑦ ⑧

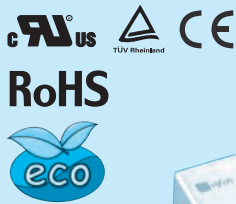

- ① Series name
 - ② Dual output
 - ③ Output wattage
 - ④ Input voltage
 - ⑤ Output voltage
 - ⑥ Mounting type
B : SMD
C : DIP
 - ⑦ Packing form
Blank: Plastic cover
P : Tray(SMD type)
 - ⑧ Optional
G : Capacitor between Input and Output is removed.
C : with coating (only DIP type)*
- * Safety standards are pending

MODEL	SUCW100512	SUCW100515	SUCW101212	SUCW101215	SUCW102412	SUCW102415	SUCW104812	SUCW104815
MAX OUTPUT WATTAGE[W]	10.8	10.5	10.8	10.5	10.8	10.5	10.8	10.5
DC OUTPUT	VOLTAGE[V] *1	± 12 or +24	± 15 or +30	± 12 or +24	± 15 or +30	± 12 or +24	± 12 or +24	± 15 or +30
	CURRENT[A]	0.45	0.35	0.45	0.35	0.45	0.45	0.35

SPECIFICATIONS

	MODEL	SUCW100512	SUCW100515	SUCW101212	SUCW101215	SUCW102412	SUCW102415	SUCW104812	SUCW104815	
INPUT	VOLTAGE[V]	DC4.5 - 9		DC9 - 18		DC18 - 36		DC36 - 76		
	CURRENT[A] *2	2.51typ	2.44typ	1.05typ	1.02typ	0.523typ	0.509typ	0.262typ	0.254typ	
	EFFICIENCY[%] *2	86typ	86typ	86typ	86typ	86typ	86typ	86typ	86typ	
OUTPUT	VOLTAGE[V]	± 12(+24)	± 15(+30)	± 12(+24)	± 15(+30)	± 12(+24)	± 15(+30)	± 12(+24)	± 15(+30)	
	CURRENT[A]	0.45	0.35	0.45	0.35	0.45	0.35	0.45	0.35	
	LINE REGULATION[mV]	60max	75max	60max	75max	60max	75max	60max	75max	
	LOAD REGULATION[mV]	600max	750max	600max	750max	600max	750max	600max	750max	
	RIPPLE[mVp-p]	-20 to +55°C *3	120max	120max	120max	120max	120max	120max	120max	120max
		-40 to -20°C *3	150max	150max	150max	150max	150max	150max	150max	150max
	RIPPLE NOISE[mVp-p]	-20 to +55°C *3	150max	150max	150max	150max	150max	150max	150max	150max
		-40 to -20°C *3	200max	200max	200max	200max	200max	200max	200max	200max
	TEMPERATURE REGULATION[mV]	-20 to +55°C	150max	180max	150max	180max	150max	180max	150max	180max
		-40 to +55°C	240max	290max	240max	290max	240max	290max	240max	290max
DRIFT[mV] *4	50max	60max	50max	60max	50max	60max	50max	60max		
START-UP TIME[ms]	20max (Minimum input, Io=100%)									
OUTPUT VOLTAGE ADJUSTMENT RANGE	Fixed (TRM pin open) ±5% adjustable by external VR									
OUTPUT VOLTAGE SETTING[V] (±5%)	11.40 - 12.60	14.25 - 15.75	11.40 - 12.60	14.25 - 15.75	11.40 - 12.60	14.25 - 15.75	11.40 - 12.60	14.25 - 15.75		
PROTECTION CIRCUIT AND OTHERS	OVERCURRENT PROTECTION	Works over 105% of rating and recovers automatically								
	REMOTE ON/OFF	Provided (Negative logic L : ON, H : OFF)								
ISOLATION	INPUT-OUTPUT	AC500V 1minute, Cutoff current = 10mA, DC500V 50MΩ min (20±15°C)								
	INPUT-CASE	AC500V 1minute, Cutoff current = 10mA, DC500V 50MΩ min (20±15°C)								
	OUTPUT-CASE	AC500V 1minute, Cutoff current = 10mA, DC500V 50MΩ min (20±15°C)								
ENVIRONMENT	OPERATING TEMP., HUMID. AND ALTITUDE	-40 to +85°C, 20 - 95%RH (Non condensing) (Refer to "Derating"), 3,000m (10,000feet) max								
	STORAGE TEMP., HUMID. AND ALTITUDE	-40 to +100°C, 20 - 95%RH (Non condensing), 9,000m (30,000feet) max								
	VIBRATION	10 - 55Hz, 98.0m/s ² (10G), 3minutes period, 60minutes each along X, Y and Z axis								
	IMPACT	490.3m/s ² (50G), 11ms, once each along X, Y and Z axis								
SAFETY	AGENCY APPROVALS	UL60950-1, C-UL, EN60950-1								
OTHERS	CASE SIZE/WEIGHT	40.2 × 7.0 × 22.0mm [1.58 × 0.28 × 0.87 inches] (W × H × D) / 10g max								
	COOLING METHOD	Convection/Forced air								

*1 Output pins can be connected in series to make a 24V/30V output.
 *2 Rated input 5V, 12V, 24V or 48V DC Io=100%
 *3 Ripple and Ripple Noise is measured by using measuring board with capacitor with in 25mm from output pin terminals.
 *4 Drift is the change in DC output for an eight hour period after a half-hour warm-up at 25°C.
 * Parallel operation with other model is not possible.

External view

1.SMD(type B)

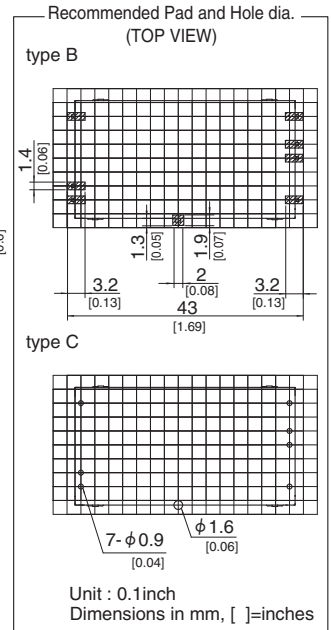
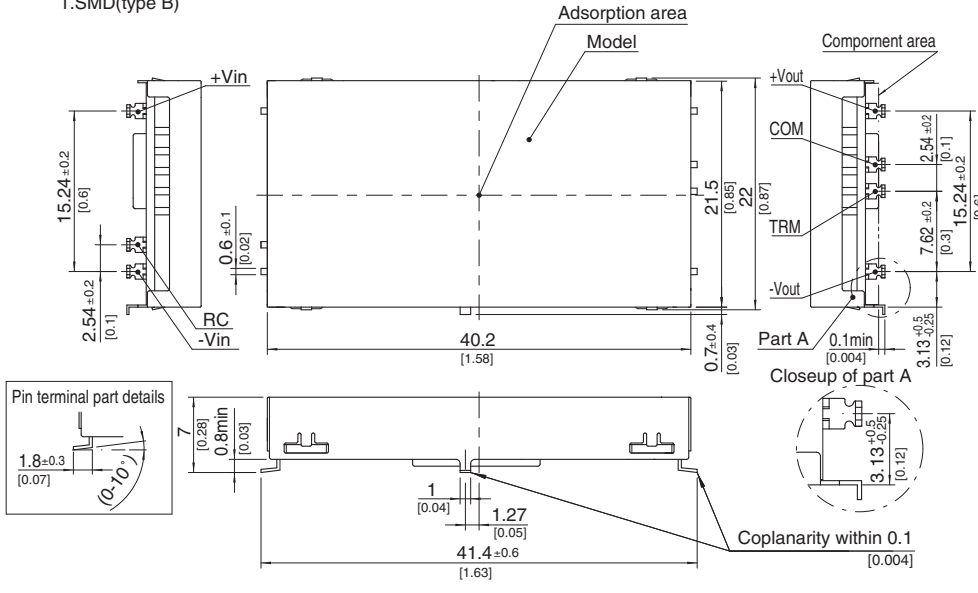

2.DIP(type C)

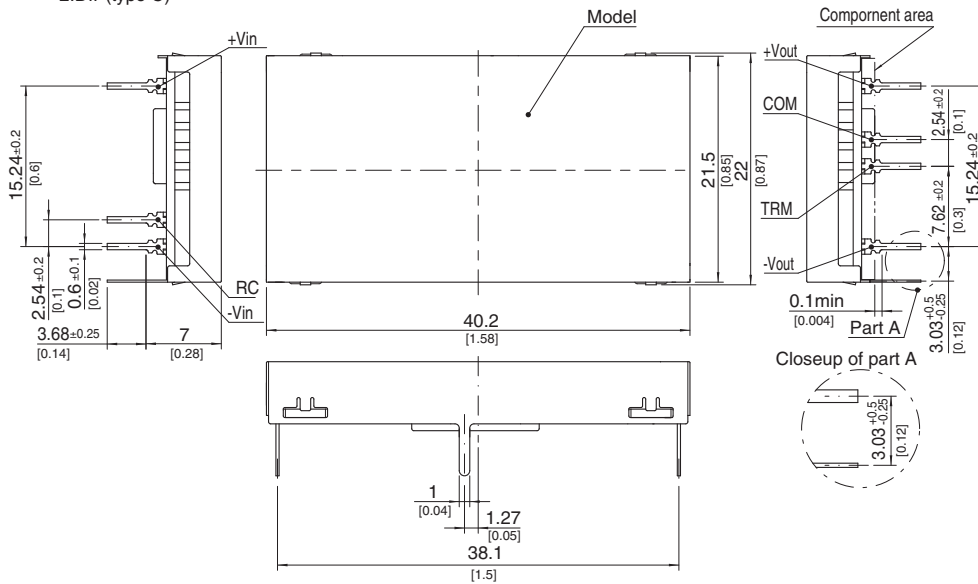

- ※ Tolerance ±0.5 [±0.02]
- ※ Dimensions in mm, []=inches
- ※ Pin terminal thickness : 0.3±0.1 [0.012]
- ※ Pin terminal material : Copper alloy
- ※ Plating treatment of terminal : Lead free plating
- ※ Case thickness : 0.2±0.05 [0.008]
- ※ Case material : Brass
- ※ Plating treatment of case : Nickel plating
- ※ Please keep enough creepage distance with the pattern on PCB and other components.
- ※ Weight : 10g max

SUTS3

SUT S 3 12 05 - □

① ② ③ ④ ⑤ ⑥

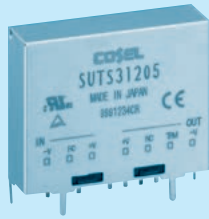
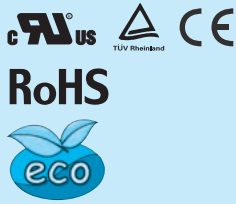

- ① Series name
 - ② Single output
 - ③ Output wattage
 - ④ Input voltage
 - ⑤ Output voltage
 - ⑥ Optional
- G : Capacitor between Input and Output is removed.

MODEL	SUTS3053R3	SUTS30505	SUTS30512	SUTS30515	SUTS3123R3	SUTS31205	SUTS31212	SUTS31215
MAX OUTPUT WATTAGE[W]	1.98	3	3	3	1.98	3	3	3
DC OUTPUT	VOLTAGE[V] *1	3.3	5	12	15	3.3	5	12
	CURRENT[A]	0.6	0.6	0.25	0.2	0.6	0.6	0.25

SPECIFICATIONS

	MODEL	SUTS3053R3	SUTS30505	SUTS30512	SUTS30515	SUTS3123R3	SUTS31205	SUTS31212	SUTS31215	
INPUT	VOLTAGE[V]	DC4.5 - 9				DC9 - 18				
	CURRENT[A] *2	0.550typ	0.800typ	0.780typ	0.780typ	0.223typ	0.325typ	0.317typ	0.321typ	
	EFFICIENCY[%] *2	72typ	75typ	77typ	77typ	74typ	77typ	79typ	78typ	
OUTPUT	VOLTAGE[V]	3.3	5	12	15	3.3	5	12	15	
	CURRENT[A]	0.6	0.6	0.25	0.2	0.6	0.6	0.25	0.2	
	LINE REGULATION[mV]	20max	20max	48max	60max	20max	20max	48max	60max	
	LOAD REGULATION[mV]	40max	40max	100max	120max	40max	40max	100max	120max	
	RIPPLE[mVp-p]	-20 to +55°C *3	80max	80max	120max	120max	80max	80max	120max	120max
		-40 to -20°C *3	120max	120max	150max	150max	120max	120max	150max	150max
	RIPPLE NOISE[mVp-p]	-20 to +55°C *3	120max	120max	150max	150max	120max	120max	150max	150max
		-40 to -20°C *3	200max	200max	200max	200max	200max	200max	200max	200max
	TEMPERATURE REGULATION[mV]	-20 to +55°C	50max	50max	150max	180max	50max	50max	150max	180max
		-40 to +55°C	80max	80max	240max	290max	80max	80max	240max	290max
	DRIFT[mV] *4	20max	20max	48max	60max	20max	20max	48max	60max	
START-UP TIME[ms]	20max (Minimum input, Io=100%)									
OUTPUT VOLTAGE ADJUSTMENT RANGE	Fixed (TRM pin open) ±5% adjustable by external VR									
OUTPUT VOLTAGE SETTING[V] (±3%)	3.21 - 3.42	4.90 - 5.21	11.64 - 12.36	14.55 - 15.45	3.21 - 3.42	4.90 - 5.21	11.64 - 12.36	14.55 - 15.45		
PROTECTION CIRCUIT AND OTHERS	OVERCURRENT PROTECTION	Works over 105% of rating and recovers automatically								
	REMOTE ON/OFF	Provided (Negative logic L : ON, H : OFF)								

MODEL	SUTS3243R3	SUTS32405	SUTS32412	SUTS32415	SUTS3483R3	SUTS34805	SUTS34812	SUTS34815
MAX OUTPUT WATTAGE[W]	1.98	3	3	3	1.98	3	3	3
DC OUTPUT	VOLTAGE[V] *1	3.3	5	12	15	3.3	5	12
	CURRENT[A]	0.6	0.6	0.25	0.2	0.6	0.6	0.25

SPECIFICATIONS

	MODEL	SUTS3243R3	SUTS32405	SUTS32412	SUTS32415	SUTS3483R3	SUTS34805	SUTS34812	SUTS34815	
INPUT	VOLTAGE[V]	DC18 - 36				DC36 - 76				
	CURRENT[A] *2	0.114typ	0.163typ	0.159typ	0.161typ	0.057typ	0.082typ	0.080typ	0.080typ	
	EFFICIENCY[%] *2	73typ	77typ	79typ	78typ	72typ	77typ	79typ	79typ	
OUTPUT	VOLTAGE[V]	3.3	5	12	15	3.3	5	12	15	
	CURRENT[A]	0.6	0.6	0.25	0.2	0.6	0.6	0.25	0.2	
	LINE REGULATION[mV]	20max	20max	48max	60max	20max	20max	48max	60max	
	LOAD REGULATION[mV]	40max	40max	100max	120max	40max	40max	100max	120max	
	RIPPLE[mVp-p]	-20 to +55°C *3	80max	80max	120max	120max	80max	80max	120max	120max
		-40 to -20°C *3	120max	120max	150max	150max	120max	120max	150max	150max
	RIPPLE NOISE[mVp-p]	-20 to +55°C *3	120max	120max	150max	150max	120max	120max	150max	150max
		-40 to -20°C *3	200max	200max	200max	200max	200max	200max	200max	200max
	TEMPERATURE REGULATION[mV]	-20 to +55°C	50max	50max	150max	180max	50max	50max	150max	180max
		-40 to +55°C	80max	80max	240max	290max	80max	80max	240max	290max
	DRIFT[mV] *4	20max	20max	48max	60max	20max	20max	48max	60max	
START-UP TIME[ms]	20max (Minimum input, Io=100%)									
OUTPUT VOLTAGE ADJUSTMENT RANGE	Fixed (TRM pin open) ±5% adjustable by external VR									
OUTPUT VOLTAGE SETTING[V] (±3%)	3.21 - 3.42	4.90 - 5.21	11.64 - 12.36	14.55 - 15.45	3.21 - 3.42	4.90 - 5.21	11.64 - 12.36	14.55 - 15.45		
PROTECTION CIRCUIT AND OTHERS	OVERCURRENT PROTECTION	Works over 105% of rating and recovers automatically								
	REMOTE ON/OFF	Provided (Negative logic L : ON, H : OFF)								

GENERAL SPECIFICATIONS

ISOLATION	INPUT-OUTPUT	AC500V 1minute, Cutoff current = 10mA, DC500V 50M Ω min (20 \pm 15 $^{\circ}$ C)
	INPUT-CASE	AC500V 1minute, Cutoff current = 10mA, DC500V 50M Ω min (20 \pm 15 $^{\circ}$ C)
	OUTPUT-CASE	AC500V 1minute, Cutoff current = 10mA, DC500V 50M Ω min (20 \pm 15 $^{\circ}$ C)
ENVIRONMENT	OPERATING TEMP., HUMID. AND ALTITUDE	-40 to +85 $^{\circ}$ C, 20 - 95%RH (Non condensing) (Refer to "Derating"), 3,000m (10,000feet) max
	STORAGE TEMP., HUMID. AND ALTITUDE	-40 to +100 $^{\circ}$ C, 20 - 95%RH (Non condensing), 9,000m (30,000feet) max
	VIBRATION	10 - 55Hz, 98.0m/s 2 (10G), 3minutes period, 60minutes each along X, Y and Z axis
	IMPACT	490.3m/s 2 (50G), 11ms, once each along X, Y and Z axis
SAFETY	AGENCY APPROVALS	UL60950-1, C-UL, EN60950-1
OTHERS	CASE SIZE/WEIGHT	30.0 x 23.4 x 9.15mm [1.18 x 0.92 x 0.36 inches] (W x H x D) / 8g max
	COOLING METHOD	Convection/Forced air

- *1 SUTW3xx12/SUTW3xx15 is available as single output, +24V/+30V.
- *2 Rated input 5V, 12V, 24V or 48V DC Io=100%
- *3 Ripple and Ripple Noise is measured by using measuring board with capacitor with in 25mm from output pin terminals.
- *4 Drift is the change in DC output for an eight hour period after a half-hour warm-up at 25 $^{\circ}$ C.
- * Parallel operation with other model is not possible.

External view

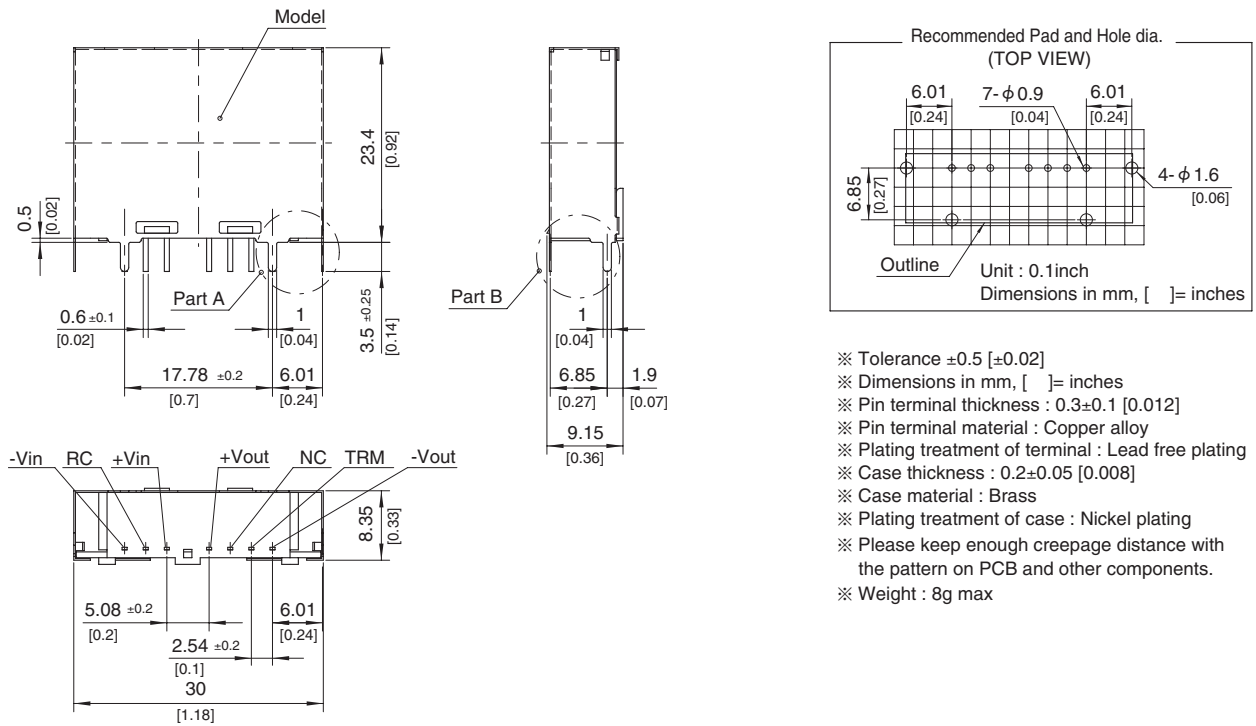

※ Back View

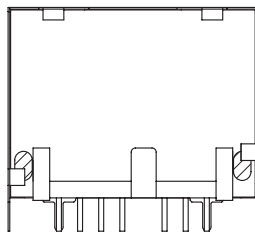

▨ : Conduction Area

Closeup of part A

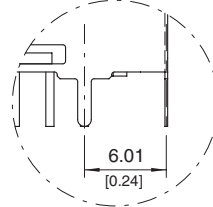

Closeup of part B

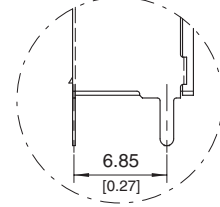

SUTW3

SUT W 3 12 12 - □

① ② ③ ④ ⑤ ⑥

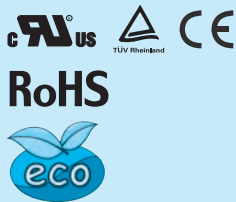

- ① Series name
- ② Dual output
- ③ Output wattage
- ④ Input voltage
- ⑤ Output voltage
- ⑥ Optional
- G :Capacitor between Input and Output is removed.

MODEL	SUTW30512	SUTW30515	SUTW31212	SUTW31215	SUTW32412	SUTW32415	SUTW34812	SUTW34815	
MAX OUTPUT WATTAGE[W]	3.12	3	3.12	3	3.12	3	3.12	3	
DC OUTPUT	VOLTAGE[V] *1	±12 or +24	±15 or +30	±12 or +24	±15 or +30	±12 or +24	±15 or +30	±12 or +24	±15 or +30
	CURRENT[A]	0.13	0.1	0.13	0.1	0.13	0.1	0.13	0.1

SPECIFICATIONS

	MODEL	SUTW30512	SUTW30515	SUTW31212	SUTW31215	SUTW32412	SUTW32415	SUTW34812	SUTW34815	
INPUT	VOLTAGE[V]	DC4.5 - 9		DC9 - 18		DC18 - 36		DC36 - 76		
	CURRENT[A] *2	0.844typ	0.811typ	0.343typ	0.329typ	0.172typ	0.165typ	0.086typ	0.083typ	
	EFFICIENCY[%] *2	74typ	74typ	76typ	76typ	76typ	76typ	76typ	76typ	
OUTPUT	VOLTAGE[V]	±12(+24)	±15(+30)	±12(+24)	±15(+30)	±12(+24)	±15(+30)	±12(+24)	±15(+30)	
	CURRENT[A]	0.13	0.1	0.13	0.1	0.13	0.1	0.13	0.1	
	LINE REGULATION[mV]	60max	75max	60max	75max	60max	75max	60max	75max	
	LOAD REGULATION[mV]	600max	750max	600max	750max	600max	750max	600max	750max	
	RIPPLE[mVp-p]	-20 to +55°C *3	120max	120max	120max	120max	120max	120max	120max	120max
		-40 to -20°C *3	150max	150max	150max	150max	150max	150max	150max	150max
	RIPPLE NOISE[mVp-p]	-20 to +55°C *3	150max	150max	150max	150max	150max	150max	150max	150max
		-40 to -20°C *3	200max	200max	200max	200max	200max	200max	200max	200max
	TEMPERATURE REGULATION[mV]	-20 to +55°C	150max	180max	150max	180max	150max	180max	150max	180max
		-40 to +55°C	240max	290max	240max	290max	240max	290max	240max	290max
DRIFT[mV] *4	50max	60max	50max	60max	50max	60max	50max	60max		
START-UP TIME[ms]	20max (Minimum input, Io=100%)									
OUTPUT VOLTAGE ADJUSTMENT RANGE	Fixed (TRM pin open) ±5% adjustable by external VR									
OUTPUT VOLTAGE SETTING[V] (±5%)	11.40 - 12.60	14.25 - 15.75	11.40 - 12.60	14.25 - 15.75	11.40 - 12.60	14.25 - 15.75	11.40 - 12.60	14.25 - 15.75	11.40 - 12.60	
PROTECTION CIRCUIT AND OTHERS	OVERCURRENT PROTECTION	Works over 105% of rating and recovers automatically								
	REMOTE ON/OFF	Provided (Negative logic L : ON, H : OFF)								
ISOLATION	INPUT-OUTPUT	AC500V 1minute, Cutoff current = 10mA, DC500V 50MΩ min (20±15°C)								
	INPUT-CASE	AC500V 1minute, Cutoff current = 10mA, DC500V 50MΩ min (20±15°C)								
	OUTPUT-CASE	AC500V 1minute, Cutoff current = 10mA, DC500V 50MΩ min (20±15°C)								
ENVIRONMENT	OPERATING TEMP., HUMID. AND ALTITUDE	-40 to +85°C, 20 - 95%RH (Non condensing) (Refer to "Derating"), 3,000m (10,000feet) max								
	STORAGE TEMP., HUMID. AND ALTITUDE	-40 to +100°C, 20 - 95%RH (Non condensing), 9,000m (30,000feet) max								
	VIBRATION	10 - 55Hz, 98.0m/s ² (10G), 3minutes period, 60minutes each along X, Y and Z axis								
	IMPACT	490.3m/s ² (50G), 11ms, once each along X, Y and Z axis								
SAFETY	AGENCY APPROVALS	UL60950-1, C-UL, EN60950-1								
OTHERS	CASE SIZE/WEIGHT	30.0 × 23.4 × 9.15mm [1.18 × 0.92 × 0.36 inches] (W × H × D) / 8g max								
	COOLING METHOD	Convection/Forced air								

*1 Output pins can be connected in series to make a 24V/30V output.
 *2 Rated input 5V, 12V, 24V or 48V DC Io=100%
 *3 Ripple and Ripple Noise is measured by using measuring board with capacitor with in 25mm from output pin terminals.
 *4 Drift is the change in DC output for an eight hour period after a half-hour warm-up at 25°C.
 * Parallel operation with other model is not possible.

External view

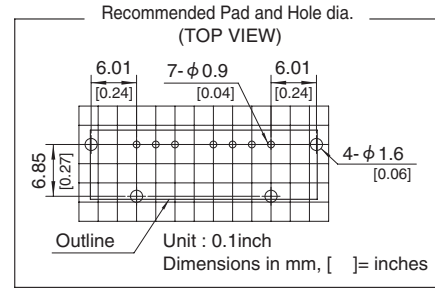
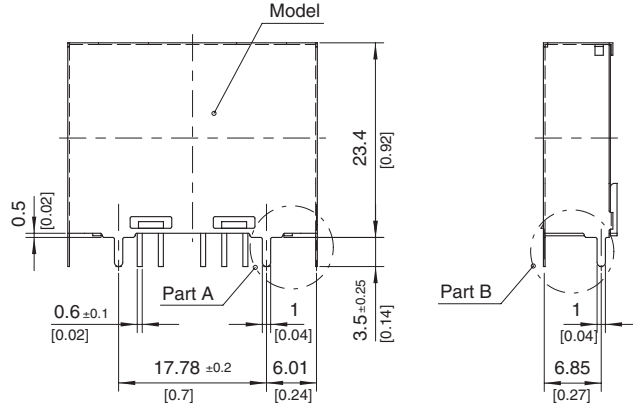

- ※ Tolerance ± 0.5 [± 0.02]
- ※ Dimensions in mm, []= inches
- ※ Pin terminal thickness : 0.3 ± 0.1 [0.012]
- ※ Pin terminal material : Copper alloy
- ※ Plating treatment of terminal : Lead free plating
- ※ Case thickness : 0.2 ± 0.05 [0.008]
- ※ Case material : Brass
- ※ Plating treatment of case : Nickel plating
- ※ Please keep enough creepage distance with the pattern on PCB and other components.
- ※ Weight : 8g max

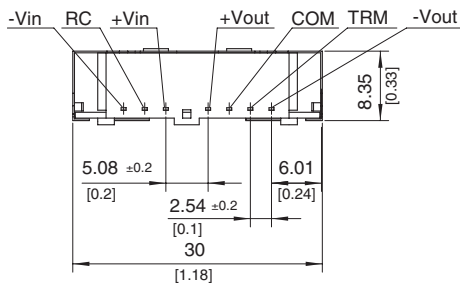

※ Back View

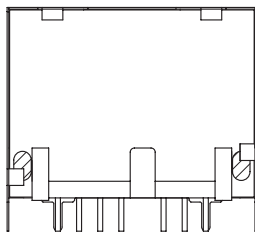

: Conduction Area

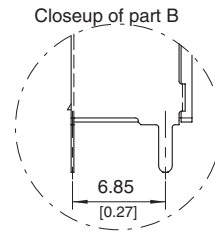
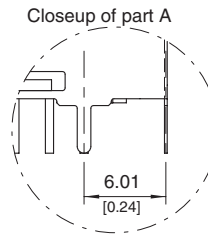

SUTS6

SUT S 6 12 05 - □

① ② ③ ④ ⑤ ⑥



- ① Series name
 - ② Single output
 - ③ Output wattage
 - ④ Input voltage
 - ⑤ Output voltage
 - ⑥ Optional
- G : Capacitor between Input and Output is removed.

MODEL	SUTS6053R3	SUTS60505	SUTS60512	SUTS60515	SUTS6123R3	SUTS61205	SUTS61212	SUTS61215	
MAX OUTPUT WATTAGE[W]	3.96	5	6	6	4.46	6	6	6	
DC OUTPUT	VOLTAGE[V] *1	3.3	5	12	15	3.3	5	12	15
	CURRENT[A]	1.2	1	0.5	0.4	1.35	1.2	0.5	0.4

SPECIFICATIONS

	MODEL	SUTS6053R3	SUTS60505	SUTS60512	SUTS60515	SUTS6123R3	SUTS61205	SUTS61212	SUTS61215	
INPUT	VOLTAGE[V]	DC4.5 - 9				DC9 - 18				
	CURRENT[A] *2	1.100typ	1.316typ	1.500typ	1.500typ	0.502typ	0.617typ	0.588typ	0.588typ	
	EFFICIENCY[%] *2	72typ	76typ	80typ	80typ	74typ	81typ	85typ	85typ	
OUTPUT	VOLTAGE[V]	3.3	5	12	15	3.3	5	12	15	
	CURRENT[A]	1.2	1	0.5	0.4	1.35	1.2	0.5	0.4	
	LINE REGULATION[mV]	20max	20max	48max	60max	20max	20max	48max	60max	
	LOAD REGULATION[mV]	40max	40max	100max	120max	40max	40max	100max	120max	
	RIPPLE[mVp-p]	-20 to +55°C *3	80max	80max	120max	120max	80max	80max	120max	120max
		-40 to -20°C *3	120max	120max	150max	150max	120max	120max	150max	150max
	RIPPLE NOISE[mVp-p]	-20 to +55°C *3	120max	120max	150max	150max	120max	120max	150max	150max
		-40 to -20°C *3	200max	200max	200max	200max	200max	200max	200max	200max
	TEMPERATURE REGULATION[mV]	-20 to +55°C	50max	50max	150max	180max	50max	50max	150max	180max
		-40 to +55°C	80max	80max	240max	290max	80max	80max	240max	290max
	DRIFT[mV] *4	20max	20max	48max	60max	20max	20max	48max	60max	
START-UP TIME[ms]	20max (Minimum input, Io=100%)									
OUTPUT VOLTAGE ADJUSTMENT RANGE	Fixed (TRM pin open) ±5% adjustable by external VR									
OUTPUT VOLTAGE SETTING[V] (±3%)	3.21 - 3.42	4.90 - 5.21	11.64 - 12.36	14.55 - 15.45	3.21 - 3.42	4.90 - 5.21	11.64 - 12.36	14.55 - 15.45		
PROTECTION CIRCUIT AND OTHERS	OVERCURRENT PROTECTION	Works over 105% of rating and recovers automatically								
	REMOTE ON/OFF	Provided (Negative logic L : ON, H : OFF)								

MODEL	SUTS6243R3	SUTS62405	SUTS62412	SUTS62415	SUTS6483R3	SUTS64805	SUTS64812	SUTS64815	
MAX OUTPUT WATTAGE[W]	4.46	6	6	6	4.46	6	6	6	
DC OUTPUT	VOLTAGE[V] *1	3.3	5	12	15	3.3	5	12	15
	CURRENT[A]	1.35	1.2	0.5	0.4	1.35	1.2	0.5	0.4

SPECIFICATIONS

	MODEL	SUTS6243R3	SUTS62405	SUTS62412	SUTS62415	SUTS6483R3	SUTS64805	SUTS64812	SUTS64815	
INPUT	VOLTAGE[V]	DC18 - 36				DC36 - 76				
	CURRENT[A] *2	0.248typ	0.309typ	0.291typ	0.291typ	0.121typ	0.154typ	0.145typ	0.145typ	
	EFFICIENCY[%] *2	75typ	81typ	86typ	86typ	77typ	81typ	86typ	86typ	
OUTPUT	VOLTAGE[V]	3.3	5	12	15	3.3	5	12	15	
	CURRENT[A]	1.35	1.2	0.5	0.4	1.35	1.2	0.5	0.4	
	LINE REGULATION[mV]	20max	20max	48max	60max	20max	20max	48max	60max	
	LOAD REGULATION[mV]	40max	40max	100max	120max	40max	40max	100max	120max	
	RIPPLE[mVp-p]	-20 to +55°C *3	80max	80max	120max	120max	80max	80max	120max	120max
		-40 to -20°C *3	120max	120max	150max	150max	120max	120max	150max	150max
	RIPPLE NOISE[mVp-p]	-20 to +55°C *3	120max	120max	150max	150max	120max	120max	150max	150max
		-40 to -20°C *3	200max	200max	200max	200max	200max	200max	200max	200max
	TEMPERATURE REGULATION[mV]	-20 to +55°C	50max	50max	150max	180max	50max	50max	150max	180max
		-40 to +55°C	80max	80max	240max	290max	80max	80max	240max	290max
	DRIFT[mV] *4	20max	20max	48max	60max	20max	20max	48max	60max	
START-UP TIME[ms]	20max (Minimum input, Io=100%)									
OUTPUT VOLTAGE ADJUSTMENT RANGE	Fixed (TRM pin open) ±5% adjustable by external VR									
OUTPUT VOLTAGE SETTING[V] (±3%)	3.21 - 3.42	4.90 - 5.21	11.64 - 12.36	14.55 - 15.45	3.21 - 3.42	4.90 - 5.21	11.64 - 12.36	14.55 - 15.45		
PROTECTION CIRCUIT AND OTHERS	OVERCURRENT PROTECTION	Works over 105% of rating and recovers automatically								
	REMOTE ON/OFF	Provided (Negative logic L : ON, H : OFF)								

GENERAL SPECIFICATIONS

ISOLATION	INPUT-OUTPUT	AC500V 1minute, Cutoff current = 10mA, DC500V 50M Ω min (20 \pm 15 $^{\circ}$ C)
	INPUT-CASE	AC500V 1minute, Cutoff current = 10mA, DC500V 50M Ω min (20 \pm 15 $^{\circ}$ C)
	OUTPUT-CASE	AC500V 1minute, Cutoff current = 10mA, DC500V 50M Ω min (20 \pm 15 $^{\circ}$ C)
ENVIRONMENT	OPERATING TEMP., HUMID. AND ALTITUDE	-40 to +85 $^{\circ}$ C, 20 - 95%RH (Non condensing) (Refer to "Derating"), 3,000m (10,000feet) max
	STORAGE TEMP., HUMID. AND ALTITUDE	-40 to +100 $^{\circ}$ C, 20 - 95%RH (Non condensing), 9,000m (30,000feet) max
	VIBRATION	10 - 55Hz, 98.0m/s 2 (10G), 3minutes period, 60minutes each along X, Y and Z axis
	IMPACT	490.3m/s 2 (50G), 11ms, once each along X, Y and Z axis
SAFETY	AGENCY APPROVALS	UL60950-1, C-UL, EN60950-1
OTHERS	CASE SIZE/WEIGHT	37.6 \times 26.4 \times 9.15mm [1.48 \times 1.04 \times 0.36 inches] (W \times H \times D) / 11g max
	COOLING METHOD	Convection/Forced air

- *1 SUTW6xx12/SUTW6xx15 is available as single output, +24V/+30V.
- *2 Rated input 5V, 12V, 24V or 48V DC I_o=100%
- *3 Ripple and Ripple Noise is measured by using measuring board with capacitor with in 25mm from output pin terminals.
- *4 Drift is the change in DC output for an eight hour period after a half-hour warm-up at 25 $^{\circ}$ C.
- * Parallel operation with other model is not possible.

External view

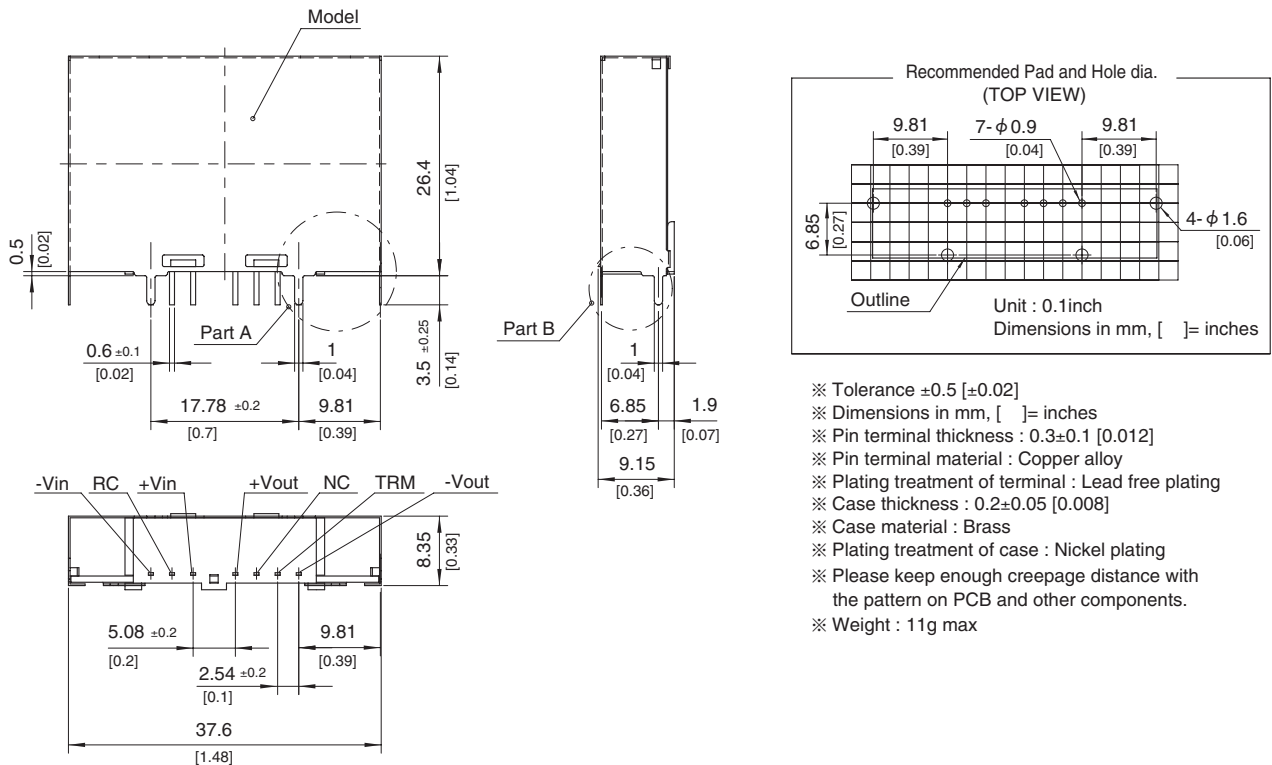

※ Back View

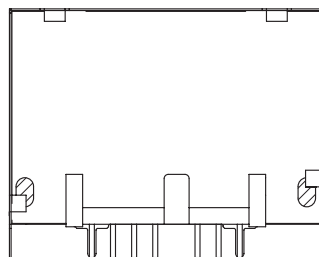

▨ : Conduction Area

Closeup of part A

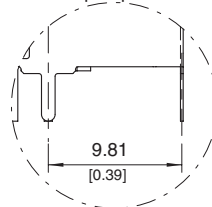

Closeup of part B

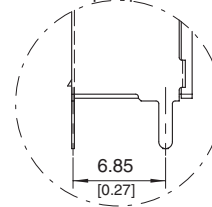

SUTW6

SUT W 6 12 12 - □

① ② ③ ④ ⑤ ⑥

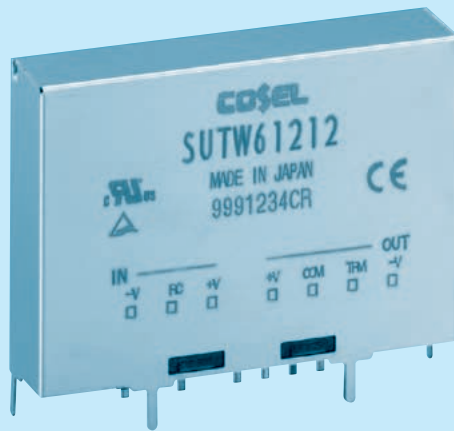
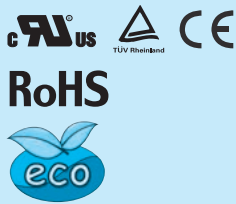

- ① Series name
- ② Dual output
- ③ Output wattage
- ④ Input voltage
- ⑤ Output voltage
- ⑥ Optional
- G :Capacitor between Input and Output is removed.

MODEL	SUTW60512	SUTW60515	SUTW61212	SUTW61215	SUTW62412	SUTW62415	SUTW64812	SUTW64815	
MAX OUTPUT WATTAGE[W]	6	6	6	6	6	6	6	6	
DC OUTPUT	VOLTAGE[V] *1	±12 or +24	±15 or +30	±12 or +24	±15 or +30	±12 or +24	±15 or +30	±12 or +24	±15 or +30
	CURRENT[A]	0.25	0.2	0.25	0.2	0.25	0.2	0.25	0.2

SPECIFICATIONS

	MODEL	SUTW60512	SUTW60515	SUTW61212	SUTW61215	SUTW62412	SUTW62415	SUTW64812	SUTW64815	
INPUT	VOLTAGE[V]	DC4.5 - 9		DC9 - 18		DC18 - 36		DC36 - 76		
	CURRENT[A] *2	1.538typ	1.538typ	0.588typ	0.588typ	0.291typ	0.291typ	0.145typ	0.145typ	
	EFFICIENCY[%] *2	78typ	78typ	85typ	85typ	86typ	86typ	86typ	86typ	
OUTPUT	VOLTAGE[V]	±12(+24)	±15(+30)	±12(+24)	±15(+30)	±12(+24)	±15(+30)	±12(+24)	±15(+30)	
	CURRENT[A]	0.25	0.2	0.25	0.2	0.25	0.2	0.25	0.2	
	LINE REGULATION[mV]	60max	75max	60max	75max	60max	75max	60max	75max	
	LOAD REGULATION[mV]	600max	750max	600max	750max	600max	750max	600max	750max	
	RIPPLE[mVp-p]	-20 to +55°C *3	120max	120max	120max	120max	120max	120max	120max	120max
		-40 to -20°C *3	150max	150max	150max	150max	150max	150max	150max	150max
	RIPPLE NOISE[mVp-p]	-20 to +55°C *3	150max	150max	150max	150max	150max	150max	150max	150max
		-40 to -20°C *3	200max	200max	200max	200max	200max	200max	200max	200max
	TEMPERATURE REGULATION[mV]	-20 to +55°C	150max	180max	150max	180max	150max	180max	150max	180max
		-40 to +55°C	240max	290max	240max	290max	240max	290max	240max	290max
DRIFT[mV] *4	50max	60max	50max	60max	50max	60max	50max	60max		
START-UP TIME[ms]	20max (Minimum input, Io=100%)									
OUTPUT VOLTAGE ADJUSTMENT RANGE	Fixed (TRM pin open) ±5% adjustable by external VR									
OUTPUT VOLTAGE SETTING[V] (±5%)	11.40 - 12.60	14.25 - 15.75	11.40 - 12.60	14.25 - 15.75	11.40 - 12.60	14.25 - 15.75	11.40 - 12.60	14.25 - 15.75	11.40 - 12.60	
PROTECTION CIRCUIT AND OTHERS	OVERCURRENT PROTECTION	Works over 105% of rating and recovers automatically								
	REMOTE ON/OFF	Provided (Negative logic L : ON, H : OFF)								
ISOLATION	INPUT-OUTPUT	AC500V 1minute, Cutoff current = 10mA, DC500V 50MΩ min (20±15°C)								
	INPUT-CASE	AC500V 1minute, Cutoff current = 10mA, DC500V 50MΩ min (20±15°C)								
	OUTPUT-CASE	AC500V 1minute, Cutoff current = 10mA, DC500V 50MΩ min (20±15°C)								
ENVIRONMENT	OPERATING TEMP., HUMID. AND ALTITUDE	-40 to +85°C, 20 - 95%RH (Non condensing) (Refer to "Derating"), 3,000m (10,000feet) max								
	STORAGE TEMP., HUMID. AND ALTITUDE	-40 to +100°C, 20 - 95%RH (Non condensing), 9,000m (30,000feet) max								
	VIBRATION	10 - 55Hz, 98.0m/s ² (10G), 3minutes period, 60minutes each along X, Y and Z axis								
	IMPACT	490.3m/s ² (50G), 11ms, once each along X, Y and Z axis								
SAFETY	AGENCY APPROVALS	UL60950-1, C-UL, EN60950-1								
OTHERS	CASE SIZE/WEIGHT	37.6 × 26.4 × 9.15mm [1.84 × 1.04 × 0.36 inches] (W × H × D) / 11g max								
	COOLING METHOD	Convection/Forced air								

*1 Output pins can be connected in series to make a 24V/30V output.
 *2 Rated input 5V, 12V, 24V or 48V DC Io=100%
 *3 Ripple and Ripple Noise is measured by using measuring board with capacitor with in 25mm from output pin terminals.
 *4 Drift is the change in DC output for an eight hour period after a half-hour warm-up at 25°C.
 * Parallel operation with other model is not possible.

External view

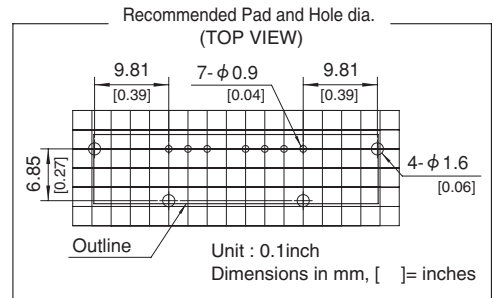
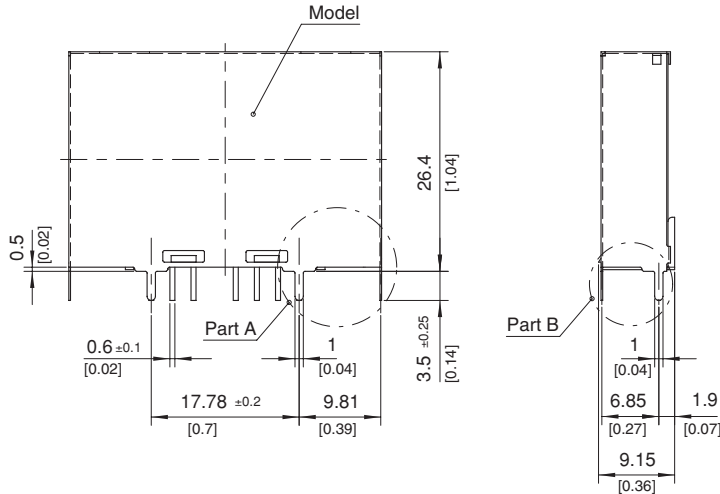

- ※ Tolerance ± 0.5 [± 0.02]
- ※ Dimensions in mm, []= inches
- ※ Pin terminal thickness : 0.3 ± 0.1 [0.012]
- ※ Pin terminal material : Copper alloy
- ※ Plating treatment of terminal : Lead free plating
- ※ Case thickness : 0.2 ± 0.05 [0.008]
- ※ Case material : Brass
- ※ Plating treatment of case : Nickel plating
- ※ Please keep enough creepage distance with the pattern on PCB and other components.
- ※ Weight : 11g max

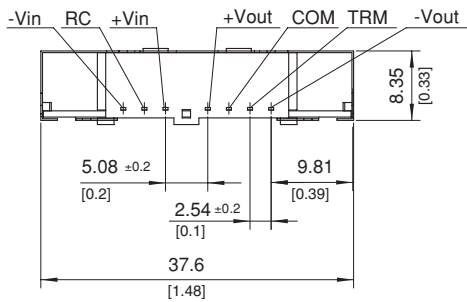

※ Back View

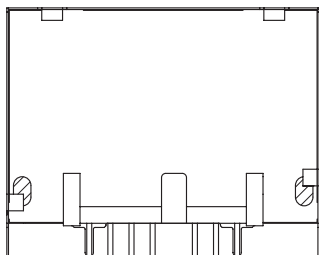

: Conduction Area

Closeup of part A

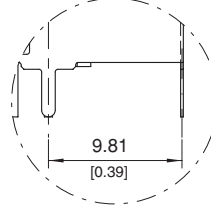

Closeup of part B

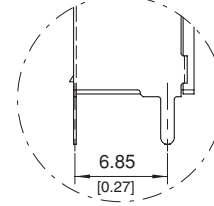

SUTS10

SUT S 10 12 05 - □

① ② ③ ④ ⑤ ⑥

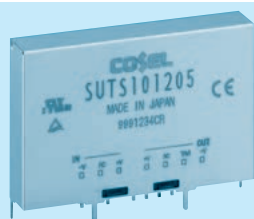
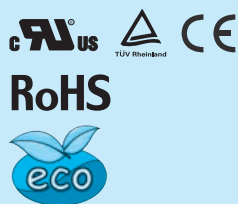

- ① Series name
 - ② Single output
 - ③ Output wattage
 - ④ Input voltage
 - ⑤ Output voltage
 - ⑥ Optional
- G :Capacitor between Input and Output is removed.

MODEL	SUTS10053R3	SUTS100505	SUTS100512	SUTS100515	SUTS10123R3	SUTS101205	SUTS101212	SUTS101215
MAX OUTPUT WATTAGE[W]	8.58	10	10.8	10.5	8.58	10	12	12
DC OUTPUT	VOLTAGE[V] *1	3.3	5	12	15	3.3	5	12
	CURRENT[A]	2.6	2	0.9	0.7	2.6	2	1

SPECIFICATIONS

	MODEL	SUTS10053R3	SUTS100505	SUTS100512	SUTS100515	SUTS10123R3	SUTS101205	SUTS101212	SUTS101215	
INPUT	VOLTAGE[V]	DC4.5 - 9				DC9 - 18				
	CURRENT[A] *2	2.12typ	2.41typ	2.54typ	2.47typ	0.872typ	0.980typ	1.15typ	1.15typ	
	EFFICIENCY[%] *2	81typ	83typ	85typ	85typ	82typ	85typ	87typ	87typ	
OUTPUT	VOLTAGE[V]	3.3	5	12	15	3.3	5	12	15	
	CURRENT[A]	2.6	2	0.9	0.7	2.6	2	1	0.8	
	LINE REGULATION[mV]	20max	20max	48max	60max	20max	20max	48max	60max	
	LOAD REGULATION[mV]	40max	40max	100max	120max	40max	40max	100max	120max	
	RIPPLE[mVp-p]	-20 to +55°C *3	80max	80max	120max	120max	80max	80max	120max	120max
		-40 to -20°C *3	120max	120max	150max	150max	120max	120max	150max	150max
	RIPPLE NOISE[mVp-p]	-20 to +55°C *3	120max	120max	150max	150max	120max	120max	150max	150max
		-40 to -20°C *3	200max	200max	200max	200max	200max	200max	200max	200max
	TEMPERATURE REGULATION[mV]	-20 to +55°C	50max	50max	150max	180max	50max	50max	150max	180max
		-40 to +55°C	80max	80max	240max	290max	80max	80max	240max	290max
	DRIFT[mV] *4	20max	20max	48max	60max	20max	20max	48max	60max	
START-UP TIME[ms]	20max (Minimum input, Io=100%)									
OUTPUT VOLTAGE ADJUSTMENT RANGE	Fixed (TRM pin open) ±5% adjustable by external VR									
OUTPUT VOLTAGE SETTING[V] (±3%)	3.21 - 3.42	4.90 - 5.21	11.64 - 12.36	14.55 - 15.45	3.21 - 3.42	4.90 - 5.21	11.64 - 12.36	14.55 - 15.45		
PROTECTION CIRCUIT AND OTHERS	OVERCURRENT PROTECTION	Works over 105% of rating and recovers automatically								
	REMOTE ON/OFF	Provided (Negative logic L : ON, H : OFF)								

MODEL	SUTS10243R3	SUTS102405	SUTS102412	SUTS102415	SUTS10483R3	SUTS104805	SUTS104812	SUTS104815
MAX OUTPUT WATTAGE[W]	8.58	10	12	12	8.58	10	12	12
DC OUTPUT	VOLTAGE[V] *1	3.3	5	12	15	3.3	5	12
	CURRENT[A]	2.6	2	1	0.8	2.6	2	1

SPECIFICATIONS

	MODEL	SUTS10243R3	SUTS102405	SUTS102412	SUTS102415	SUTS10483R3	SUTS104805	SUTS104812	SUTS104815	
INPUT	VOLTAGE[V]	DC18 - 36				DC36 - 76				
	CURRENT[A] *2	0.436typ	0.490typ	0.575typ	0.575typ	0.218typ	0.245typ	0.287typ	0.287typ	
	EFFICIENCY[%] *2	82typ	85typ	87typ	87typ	82typ	85typ	87typ	87typ	
OUTPUT	VOLTAGE[V]	3.3	5	12	15	3.3	5	12	15	
	CURRENT[A]	2.6	2	1	0.8	2.6	2	1	0.8	
	LINE REGULATION[mV]	20max	20max	48max	60max	20max	20max	48max	60max	
	LOAD REGULATION[mV]	40max	40max	100max	120max	40max	40max	100max	120max	
	RIPPLE[mVp-p]	-20 to +55°C *3	80max	80max	120max	120max	80max	80max	120max	120max
		-40 to -20°C *3	120max	120max	150max	150max	120max	120max	150max	150max
	RIPPLE NOISE[mVp-p]	-20 to +55°C *3	120max	120max	150max	150max	120max	120max	150max	150max
		-40 to -20°C *3	200max	200max	200max	200max	200max	200max	200max	200max
	TEMPERATURE REGULATION[mV]	-20 to +55°C	50max	50max	150max	180max	50max	50max	150max	180max
		-40 to +55°C	80max	80max	240max	290max	80max	80max	240max	290max
	DRIFT[mV] *4	20max	20max	48max	60max	20max	20max	48max	60max	
START-UP TIME[ms]	20max (Minimum input, Io=100%)									
OUTPUT VOLTAGE ADJUSTMENT RANGE	Fixed (TRM pin open) ±5% adjustable by external VR									
OUTPUT VOLTAGE SETTING[V] (±3%)	3.21 - 3.42	4.90 - 5.21	11.64 - 12.36	14.55 - 15.45	3.21 - 3.42	4.90 - 5.21	11.64 - 12.36	14.55 - 15.45		
PROTECTION CIRCUIT AND OTHERS	OVERCURRENT PROTECTION	Works over 105% of rating and recovers automatically								
	REMOTE ON/OFF	Provided (Negative logic L : ON, H : OFF)								

GENERAL SPECIFICATIONS

ISOLATION	INPUT-OUTPUT	AC500V 1minute, Cutoff current = 10mA, DC500V 50M Ω min (20 \pm 15 $^{\circ}$ C)
	INPUT-CASE	AC500V 1minute, Cutoff current = 10mA, DC500V 50M Ω min (20 \pm 15 $^{\circ}$ C)
	OUTPUT-CASE	AC500V 1minute, Cutoff current = 10mA, DC500V 50M Ω min (20 \pm 15 $^{\circ}$ C)
ENVIRONMENT	OPERATING TEMP., HUMID. AND ALTITUDE	-40 to +85 $^{\circ}$ C, 20 - 95%RH (Non condensing) (Refer to "Derating"), 3,000m (10,000feet) max
	STORAGE TEMP., HUMID. AND ALTITUDE	-40 to +100 $^{\circ}$ C, 20 - 95%RH (Non condensing), 9,000m (30,000feet) max
	VIBRATION	10 - 55Hz, 98.0m/s 2 (10G), 3minutes period, 60minutes each along X, Y and Z axis
	IMPACT	490.3m/s 2 (50G), 11ms, once each along X, Y and Z axis
SAFETY	AGENCY APPROVALS	UL60950-1, C-UL, EN60950-1
OTHERS	CASE SIZE/WEIGHT	45.2 x 29.3 x 9.15mm [1.78 x 1.15 x 0.36 inches] (W x H x D) / 14g max
	COOLING METHOD	Convection/Forced air

- *1 SUTW10xx12/SUTW10xx15 is available as single output, +24V/+30V.
- *2 Rated input 5V, 12V, 24V or 48V DC I_o=100%
- *3 Ripple and Ripple Noise is measured by using measuring board with capacitor with in 25mm from output pin terminals.
- *4 Drift is the change in DC output for an eight hour period after a half-hour warm-up at 25 $^{\circ}$ C.
- * Parallel operation with other model is not possible.

External view

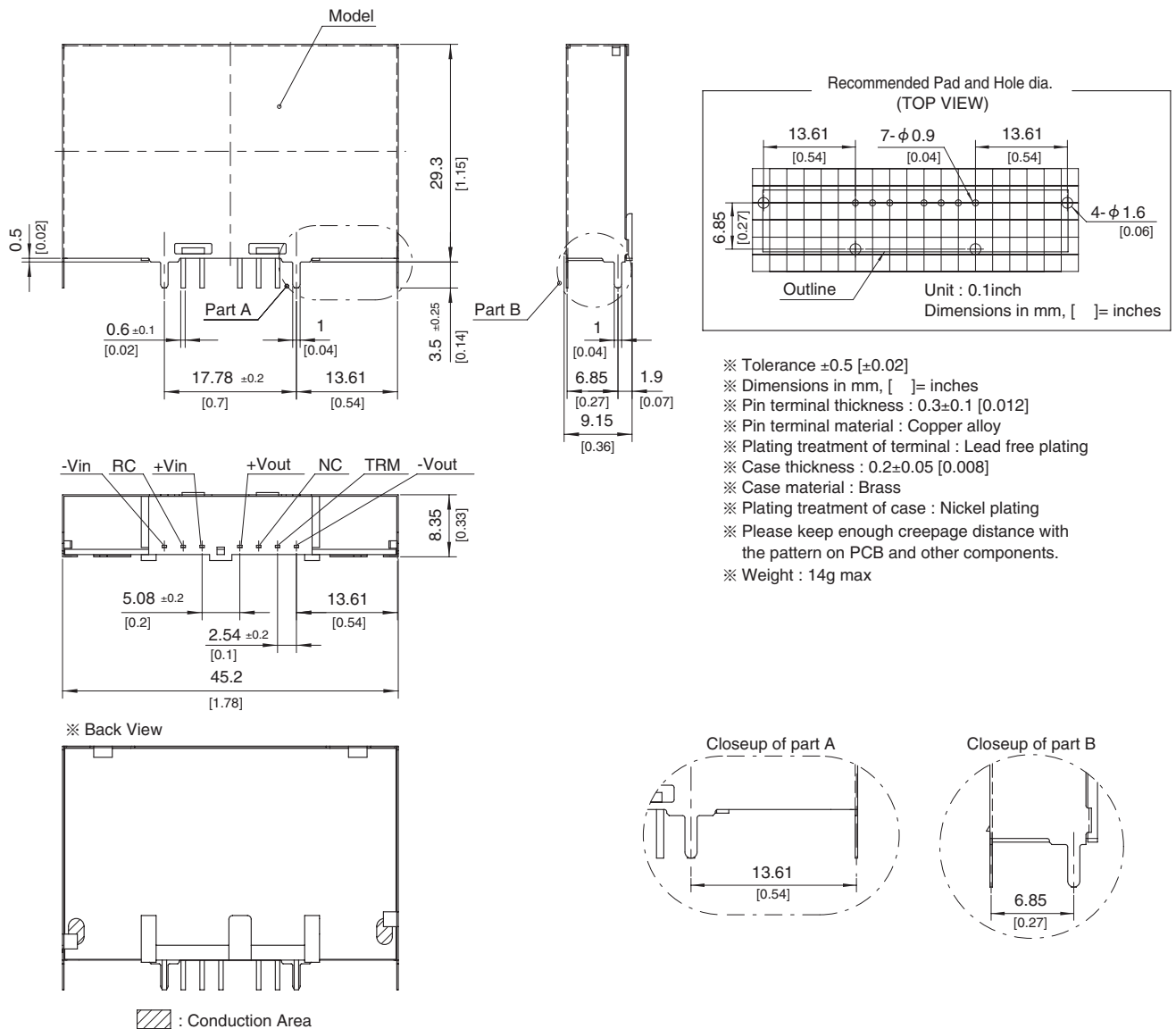

SUTW10

SUT W 10 12 12 - □

① ② ③ ④ ⑤ ⑥

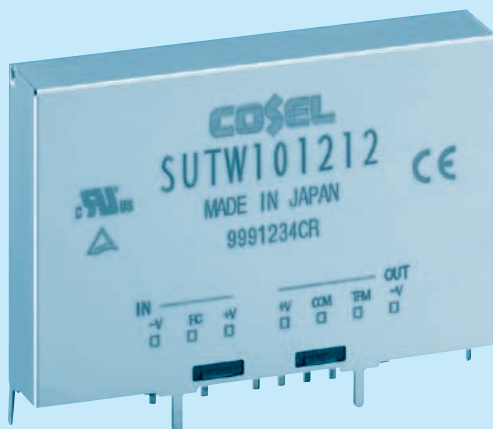

- ① Series name
- ② Dual output
- ③ Output wattage
- ④ Input voltage
- ⑤ Output voltage
- ⑥ Optional
- G :Capacitor between Input and Output is removed.

MODEL	SUTW100512	SUTW100515	SUTW101212	SUTW101215	SUTW102412	SUTW102415	SUTW104812	SUTW104815	
MAX OUTPUT WATTAGE[W]	10.8	10.5	10.8	10.5	10.8	10.5	10.8	10.5	
DC OUTPUT	VOLTAGE[V] *1	±12 or +24	±15 or +30	±12 or +24	±15 or +30	±12 or +24	±15 or +30	±12 or +24	±15 or +30
	CURRENT[A]	0.45	0.35	0.45	0.35	0.45	0.35	0.45	0.35

SPECIFICATIONS

	MODEL	SUTW100512	SUTW100515	SUTW101212	SUTW101215	SUTW102412	SUTW102415	SUTW104812	SUTW104815	
INPUT	VOLTAGE[V]	DC4.5 - 9		DC9 - 18		DC18 - 36		DC36 - 76		
	CURRENT[A] *2	2.51typ	2.44typ	1.05typ	1.02typ	0.523typ	0.509typ	0.262typ	0.254typ	
	EFFICIENCY[%] *2	86typ	86typ	86typ	86typ	86typ	86typ	86typ	86typ	
OUTPUT	VOLTAGE[V]	±12(+24)	±15(+30)	±12(+24)	±15(+30)	±12(+24)	±15(+30)	±12(+24)	±15(+30)	
	CURRENT[A]	0.45	0.35	0.45	0.35	0.45	0.35	0.45	0.35	
	LINE REGULATION[mV]	60max	75max	60max	75max	60max	75max	60max	75max	
	LOAD REGULATION[mV]	600max	750max	600max	750max	600max	750max	600max	750max	
	RIPPLE[mVp-p]	-20 to +55°C *3	120max	120max	120max	120max	120max	120max	120max	120max
		-40 to -20°C *3	150max	150max	150max	150max	150max	150max	150max	150max
	RIPPLE NOISE[mVp-p]	-20 to +55°C *3	150max	150max	150max	150max	150max	150max	150max	150max
		-40 to -20°C *3	200max	200max	200max	200max	200max	200max	200max	200max
	TEMPERATURE REGULATION[mV]	-20 to +55°C	150max	180max	150max	180max	150max	180max	150max	180max
		-40 to +55°C	240max	290max	240max	290max	240max	290max	240max	290max
DRIFT[mV] *4	50max	60max	50max	60max	50max	60max	50max	60max		
START-UP TIME[ms]	20max (Minimum input, Io=100%)									
OUTPUT VOLTAGE ADJUSTMENT RANGE	Fixed (TRM pin open) ±5% adjustable by external VR									
OUTPUT VOLTAGE SETTING[V] (±5%)	11.40 - 12.60	14.25 - 15.75	11.40 - 12.60	14.25 - 15.75	11.40 - 12.60	14.25 - 15.75	11.40 - 12.60	14.25 - 15.75		
PROTECTION CIRCUIT AND OTHERS	OVERCURRENT PROTECTION	Works over 105% of rating and recovers automatically								
	REMOTE ON/OFF	Provided (Negative logic L : ON, H : OFF)								
ISOLATION	INPUT-OUTPUT	AC500V 1minute, Cutoff current = 10mA, DC500V 50MΩ min (20±15°C)								
	INPUT-CASE	AC500V 1minute, Cutoff current = 10mA, DC500V 50MΩ min (20±15°C)								
	OUTPUT-CASE	AC500V 1minute, Cutoff current = 10mA, DC500V 50MΩ min (20±15°C)								
ENVIRONMENT	OPERATING TEMP., HUMID. AND ALTITUDE	-40 to +85°C, 20 - 95%RH (Non condensing) (Refer to "Derating"), 3,000m (10,000feet) max								
	STORAGE TEMP., HUMID. AND ALTITUDE	-40 to +100°C, 20 - 95%RH (Non condensing), 9,000m (30,000feet) max								
	VIBRATION	10 - 55Hz, 98.0m/s ² (10G), 3minutes period, 60minutes each along X, Y and Z axis								
	IMPACT	490.3m/s ² (50G), 11ms, once each along X, Y and Z axis								
SAFETY	AGENCY APPROVALS	UL60950-1, C-UL, EN60950-1								
OTHERS	CASE SIZE/WEIGHT	45.2 × 29.3 × 9.15mm [1.78 × 1.15 × 0.36 inches] (W × H × D) / 14g max								
	COOLING METHOD	Convection/Forced air								

*1 Output pins can be connected in series to make a 24V/30V output.
 *2 Rated input 5V, 12V, 24V or 48V DC Io=100%
 *3 Ripple and Ripple Noise is measured by using measuring board with capacitor with in 25mm from output pin terminals.
 *4 Drift is the change in DC output for an eight hour period after a half-hour warm-up at 25°C.
 * Parallel operation with other model is not possible.

External view

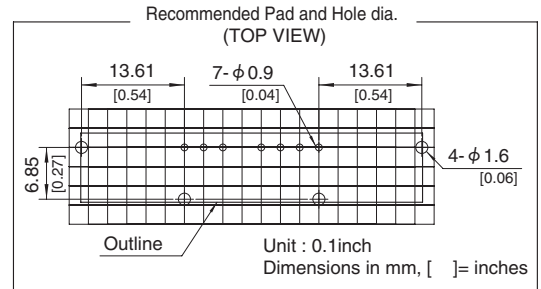
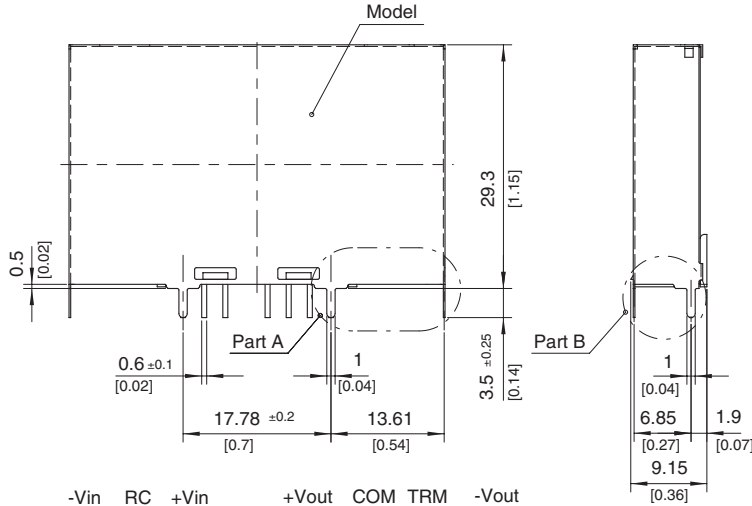

- ※ Tolerance ± 0.5 [± 0.02]
- ※ Dimensions in mm, [] = inches
- ※ Pin terminal thickness : 0.3 ± 0.1 [0.012]
- ※ Pin terminal material : Copper alloy
- ※ Plating treatment of terminal : Lead free plating
- ※ Case thickness : 0.2 ± 0.05 [0.008]
- ※ Case material : Brass
- ※ Plating treatment of case : Nickel plating
- ※ Please keep enough creepage distance with the pattern on PCB and other components.
- ※ Weight : 14g max

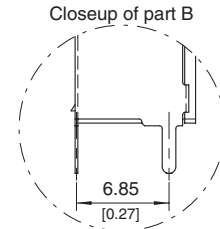
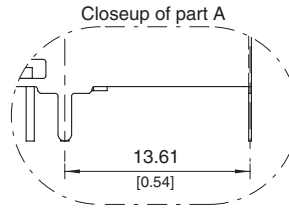
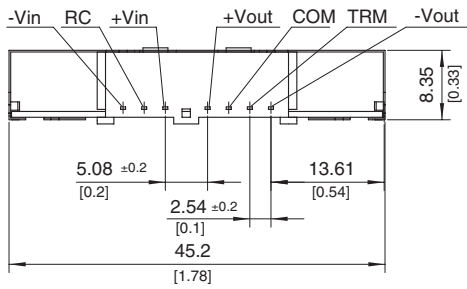

※ Back View

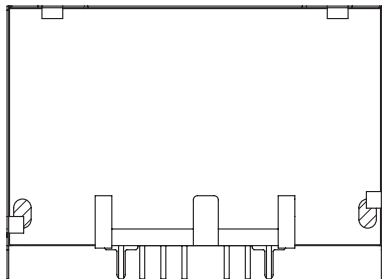

▨ : Conduction Area

Pin Configuration

● SU/SUC Single Output

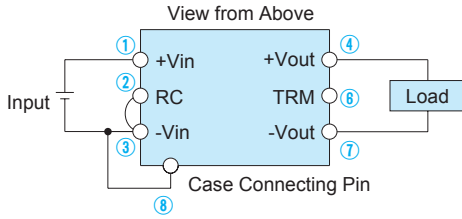

● SU/SUC Dual (\pm) Output

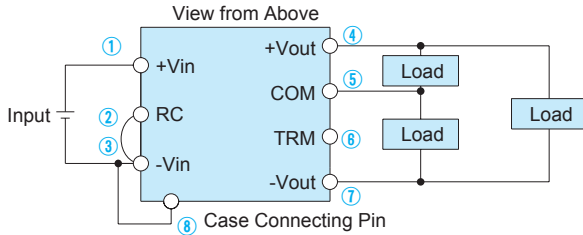

● SU/SUC Single Output, Dual (\pm) Output

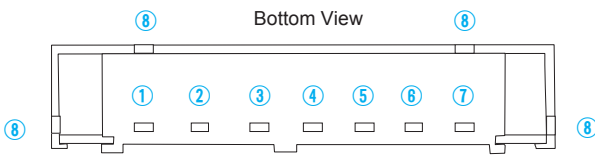

Pin No.	Pin Terminal Name	Function
①	+Vin	+DC Input
②	RC	Remote ON/OFF (excluding 1R5)
③	-Vin	-DC Input
④	+Vout	+DC Output
⑤	COM	GND of Output Voltage (for Dual Output)
⑥	TRM	Output Voltage Adjustment (please see Instruction Manual 1.4)
⑦	-Vout	-DC Output
⑧	Case Connecting Pin	If connected to -Vin, a case potential becomes fixed and radiation noise decreases (applicable only to SUC series).

Pin No.	Pin Terminal Name	Function
①	-Vin	-DC Input
②	RC	Remote ON/OFF
③	+Vin	+DC Input
④	+Vout	+DC Output
⑤	NC (Single output) COM (Dual output)	GND of Output Voltage
⑥	TRM	Output Voltage Adjustment
⑦	-Vout	-DC Output
⑧	Case Connecting Pin	If connected to -Vin, a case potential becomes fixed and radiation noise decreases.

■ Case Connecting Pin Terminal

Units come with a case connecting pin terminal. If this pin terminal is connected to -Vin, radiation noise from the main body decreases. Solder the case connecting pin terminal to PCB to improve reliability.

Assembling and Installation Method

Installation

- You can install the units in any direction. Place them in such a way that there is enough ventilation so that heat does not get accumulated around them.
- Do not place a rand or a pattern layout in the hatched area shown in below. Doing so may cause insulation failure on the PCB surface on which the power supply is mounted.

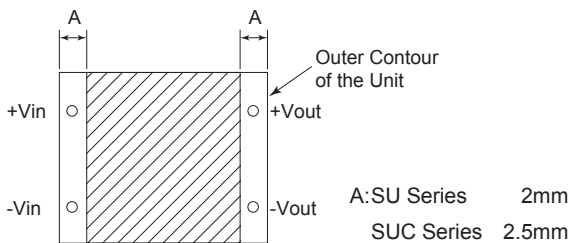

Area where Pattern Layout should not be Placed for SU/SUC

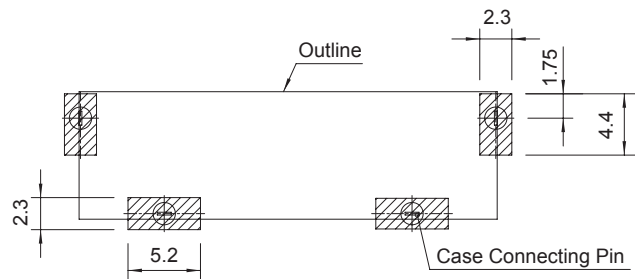

Area where Pattern Layout should not be Placed for SUT

Assembling and Installation Method

Automatic Mounting (TYPE: BP)

■ To mount SU series automatically, use the transformer area near the center of the PCB as a pickup point. To mount SUC series automatically, use the central area of the case as a pickup point. If the bottom dead point of a suction nozzle is too low when mounting, excessive force is applied to the transformer, which could cause damage. Please mount carefully. Please see the External View for details of the pickup point.

Hand Mounting (TYPE: B, C SUT)

- To mount SU series manually, it must be push the transformer placed center of PS.
- To mount SUC series manually, it must be push the center of case.
- Due to prevent failure, PS should not be pull after soldering with PCB.

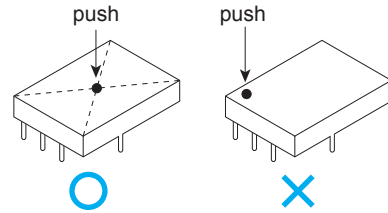

Soldering Conditions

(1) Reflow Soldering (except SUT, SUC□□C-C)

- Right figure shows conditions for the reflow soldering for SU/SUC series. Please make sure that the temperatures of pin terminals +Vin and -Vout shown in right figure . do not exceed the temperatures shown in right figure.
- If time or temperature of the reflow soldering goes beyond the conditions, reliability of internal components may be compromised. Please use the unit under the recommended reflow conditions.
- With this reflow profile, internal solder melts down. When transporting the unit within the reflow oven, please do not give vibration to the unit.
- Please avoid reflow soldering after applying adhesive or coating to the unit.
- You can reflow solder up to 2 times. Do not reflow solder when the power supply is mounted on the back surface of the PCB because the unit may drop.

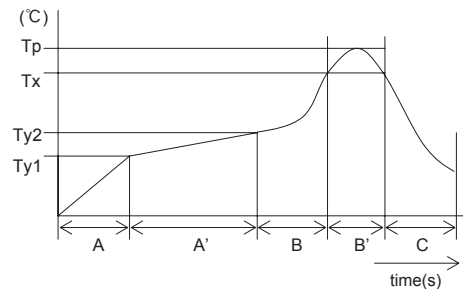
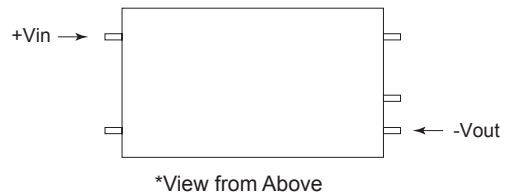

A	1.0 - 5.0°C/s
A'	Ty1 : 160 ±20°C
	Ty2 : 180 ±20°C
	Ty1 - Ty2 : 120s max
B	1.0 - 5.0°C/s
B'	Tp : Max 245°C 10s max
	Tx : 220°C or more : 70s max
C	1.0 - 5.0°C/s

- (2) Flow Soldering : 260°C 15 seconds or less
- (3) Soldering Iron : maximum 360°C 5 seconds or less

Stress to Pin Terminals

- If too much stress is applied to input/output pin terminals of the power supply, internal connection may come down. If you apply stress as shown below, please kept it at 19.6N (2kgf) or less vertically.
- Input/output pin terminals are soldered to the PCB internally. Do not pull or bend a lead powerfully.
- If it is expected that stress is applied to the input/output pin terminals due to vibration or impact, reduce the stress to the pin terminals by taking such measures as fixing the unit to the PCB by silicone rubber, etc.

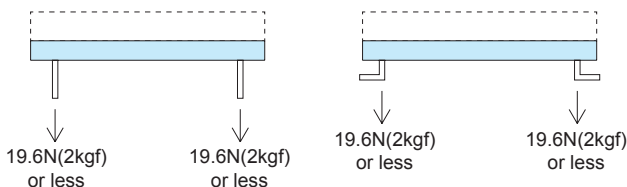

Strength of Input/Output Pin Terminals for SU/SUC

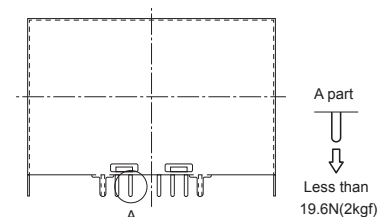

Strength of Input/Output Pin Terminals for SUT

Derating

Ambient temperature derating curve

- It is necessary to note thermal fatigue life by power cycle. Please reduce the temperature fluctuation range as much as possible when the up and down of temperature are frequently generated.
- In the case of forced air cooling, Please have sufficient ventilation to keep the temperature of point in Instruction Manual 7. Please also make sure that the ambient temperature does not exceed 85°C.

● SU/SUC1R5

(1) In the case of Convection Cooling

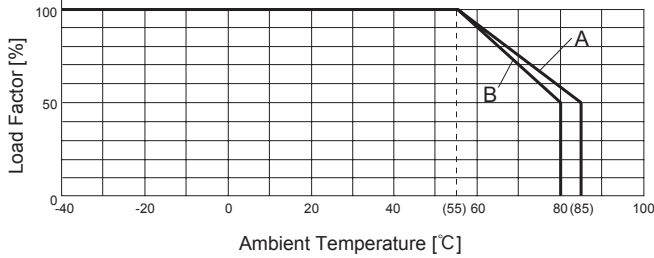

Output Voltage(V) Input Voltage(V)	3.3	5	12	15	±12	±15
5	A	A	A	A	A	A
12	A	A	A	A	A	A
24	A	A	A	A	A	A
48	B	B	B	B	B	B

(2) In the case of Forced Air Cooling (1m/s)

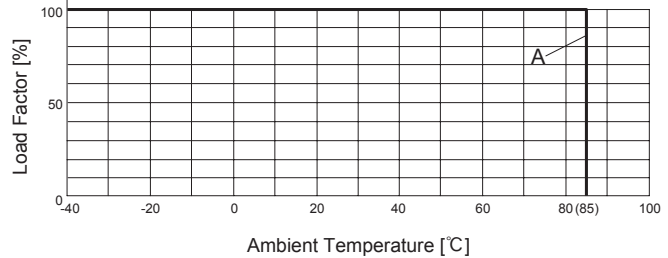

Output Voltage(V) Input Voltage(V)	3.3	5	12	15	±12	±15
5	A	A	A	A	A	A
12	A	A	A	A	A	A
24	A	A	A	A	A	A
48	A	A	A	A	A	A

● SU/SUC3

(1) In the case of Convection Cooling

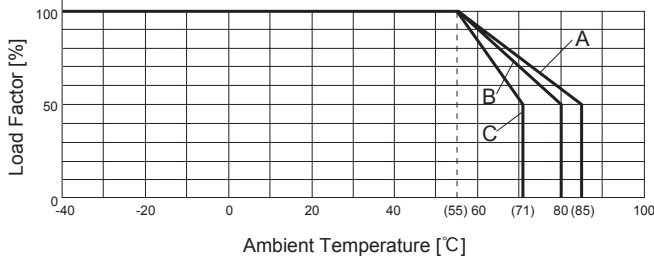

Output Voltage(V) Input Voltage(V)	3.3	5	12	15	±12	±15
5	A	A	B	B	A	B
12	A	A	B	B	A	B
24	A	A	B	B	A	B
48	B	B	B	B	A	C

(2) In the case of Forced Air Cooling (1m/s)

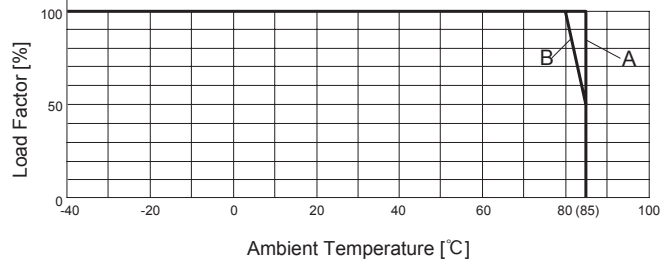

Output Voltage(V) Input Voltage(V)	3.3	5	12	15	±12	±15
5	A	B	B	B	B	B
12	A	A	A	A	A	B
24	A	A	B	A	A	B
48	A	A	A	A	A	B

● SU/SUC6

(1) In the case of Convection Cooling

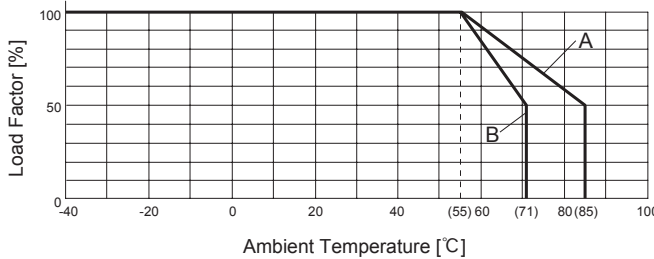

Output Voltage(V) Input Voltage(V)	3.3	5	12	15	±12	±15
5	B	B	B	B	B	B
12	B	B	B	B	B	B
24	B	B	B	B	B	B
48	B	B	A	A	A	A

(2) In the case of Forced Air Cooling (1m/s)

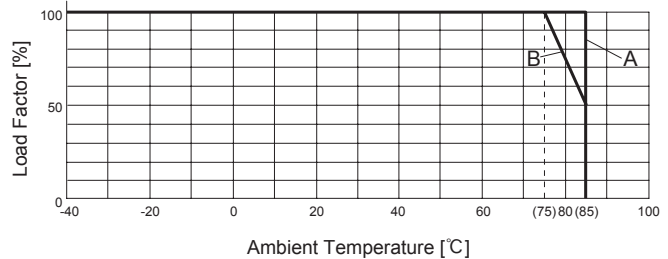

Output Voltage(V) Input Voltage(V)	3.3	5	12	15	±12	±15
5	B	B	A	A	A	A
12	B	B	A	A	A	A
24	B	B	A	A	A	A
48	B	B	A	A	A	A

Derating

● SU/SUC10

(1) In the case of Convection Cooling

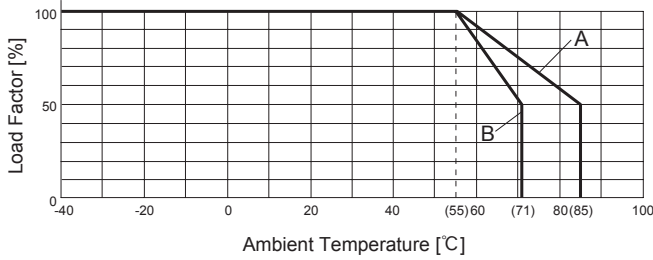

Output Voltage(V) Input Voltage(V)	3.3	5	12	15	±12	±15
5	B	A	A	A	A	A
12	B	A	A	A	A	A
24	B	A	A	A	A	A
48	B	B	B	B	B	B

(2) In the case of Forced Air Cooling (1m/s)

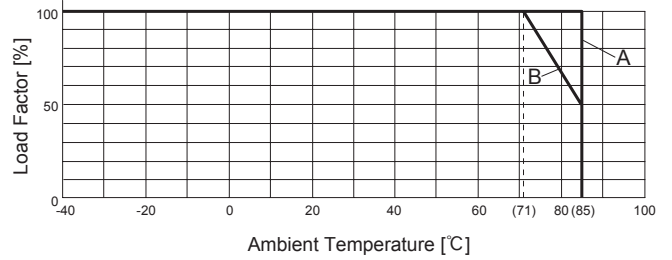

Output Voltage(V) Input Voltage(V)	3.3	5	12	15	±12	±15
5	B	B	B	B	A	A
12	B	B	B	B	A	A
24	B	B	B	B	A	A
48	B	B	B	B	B	B

● SUT3

(1) In the case of Convection Cooling

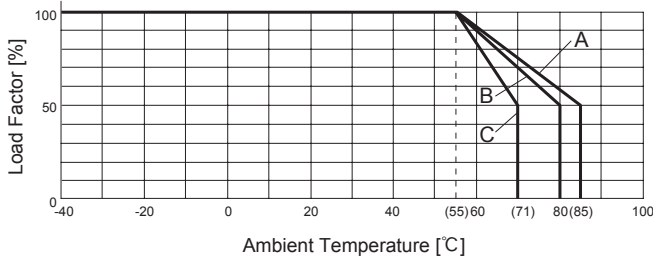

Output Voltage(V) Input Voltage(V)	3.3	5	12	15	±12	±15
5	A	A	B	B	A	B
12	A	A	B	B	A	B
24	A	A	B	B	A	B
48	B	B	B	B	A	C

(2) In the case of Forced Air Cooling (1m/s)

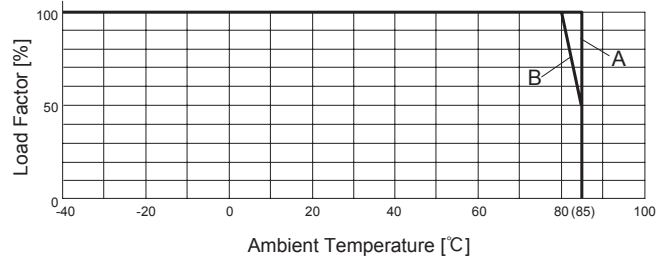

Output Voltage(V) Input Voltage(V)	3.3	5	12	15	±12	±15
5	A	B	B	B	B	B
12	A	A	A	A	A	B
24	A	A	B	A	A	B
48	A	A	A	A	A	B

● SUT6

(1) In the case of Convection Cooling

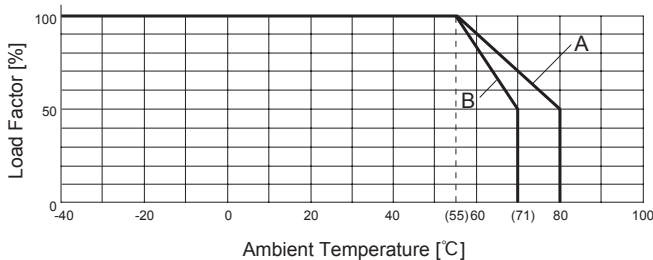

Output Voltage(V) Input Voltage(V)	3.3	5	12	15	±12	±15
5	B	B	B	B	B	B
12	B	B	B	B	B	B
24	B	B	B	B	B	B
48	B	B	A	A	A	A

(2) In the case of Forced Air Cooling (1m/s)

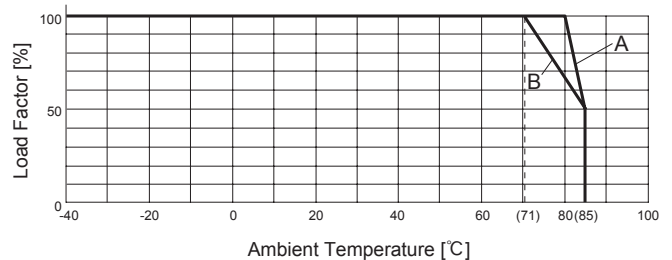

Output Voltage(V) Input Voltage(V)	3.3	5	12	15	±12	±15
5	B	B	B	B	B	B
12	B	B	A	A	A	A
24	B	B	A	A	A	A
48	B	B	A	A	A	A

Derating

SUT10

(1) In the case of Convection Cooling

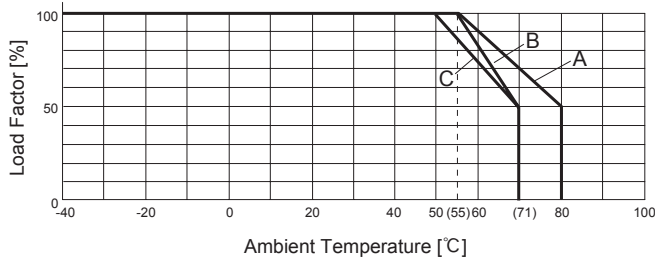

Output Voltage(V) Input Voltage(V)	3.3	5	12	15	±12	±15
5	C	C	A	A	C	C
12	B	A	A	A	B	A
24	C	C	C	C	C	B
48	C	C	C	C	C	C

(2) In the case of Forced Air Cooling (1m/s)

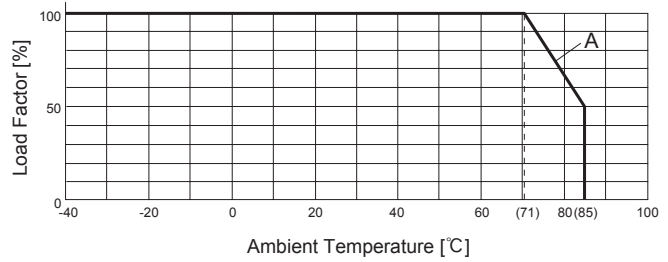

Output Voltage(V) Input Voltage(V)	3.3	5	12	15	±12	±15
5	A	A	A	A	A	A
12	A	A	A	A	A	A
24	A	A	A	A	A	A
48	A	A	A	A	A	A

Instruction Manual

◆ It is necessary to read the "Instruction Manual" and "Before using our product" before you use our product.

Instruction Manual	https://en.cosel.co.jp/product/powersupply/SUS/
Instruction Manual	https://en.cosel.co.jp/product/powersupply/SUW/
Instruction Manual	https://en.cosel.co.jp/product/powersupply/SUCS/
Instruction Manual	https://en.cosel.co.jp/product/powersupply/SUCW/
Instruction Manual	https://en.cosel.co.jp/product/powersupply/SUTS/
Instruction Manual	https://en.cosel.co.jp/product/powersupply/SUTW/
Before using our product	https://en.cosel.co.jp/technical/caution/index.html

SUS



SUCS



SUTS



SUW



SUCW



SUTW



NOTICE



Basic Characteristics Data

Model	Circuit method	Switching frequency [kHz] (reference)	Input current [A]	Inrush current protection	PCB/Pattern			Series/Parallel operation availability	
					Material	Single sided	Double sided	Series operation	Parallel operation
SU/SUC1R5	Flyback converter	350 - 1900	Refer to Table1,2	-	glass fabric base,epoxy resin		Yes	Yes	*1
SU/SUC3	Flyback converter	200 - 1400	Refer to Table1,2	-	glass fabric base,epoxy resin		Yes	Yes	*1
SU/SUC6	Flyback converter	230 - 1950	Refer to Table1,2	-	glass fabric base,epoxy resin		Yes	Yes	*1
SU/SUC10	Flyback converter	250 - 300	Refer to Table1,2	-	glass fabric base,epoxy resin		Yes	Yes	*1
SUT3	Flyback converter	200 - 1400	Refer to Table1,2	-	glass fabric base,epoxy resin		Yes	Yes	*1
SUT6	Flyback converter	230 - 1950	Refer to Table1,2	-	glass fabric base,epoxy resin		Yes	Yes	*1
SUT10	Flyback converter	250 - 300	Refer to Table1,2	-	glass fabric base,epoxy resin		Yes	Yes	*1

*1 Refer to Instruction Manual.

* The value of input current is measured at rated input and load.

Table1 (SUS*** +5V output)

[A]

Output Power	Input Voltage			
	5V	12V	24V	48V
1.5W	0.41	0.16	0.08	0.04
3W	0.78	0.32	0.16	0.08
6W	1.32	0.62	0.31	0.15
10W	2.41	0.98	0.49	0.25

Table2 (SUW*** ±12V output)

[A]

Output Power	Input Voltage			
	5V	12V	24V	48V
1.5W	0.43	0.17	0.09	0.04
3W	0.82	0.33	0.17	0.08
6W	1.54	0.59	0.29	0.15
10W	2.51	1.05	0.52	0.26