

BUV26

Switch-mode Series NPN Silicon Power Transistor

Designed for high-speed applications.

Features

- Switch-mode Power Supplies
- High Frequency Converters
- Relay Drivers
- Driver
- These Devices are Pb-Free and are RoHS Compliant*

MAXIMUM RATINGS (T_J = 25°C unless otherwise noted)

Rating	Symbol	Value	Unit
Collector-Emitter Voltage	V _{CEO(sus)}	90	Vdc
Collector-Base Voltage	V _{CBO}	180	Vdc
Emitter-Base Voltage	V _{EBO}	7.0	Vdc
Collector Current – Continuous	I _C	20	Adc
Collector Current – Peak (pw 10 ms)	I _{CM}	30	Adc
Base Current – Continuous	I _B	4.0	Adc
Base Current – Peak	I _{BM}	6.0	Adc
Total Power Dissipation @ T _C = 25°C	P _D	85	W
Total Power Dissipation @ T _C = 60°C	P _D	65	W
Operating and Storage Junction Temperature Range	T _J , T _{stg}	- 65 to +175	°C

Stresses exceeding those listed in the Maximum Ratings table may damage the device. If any of these limits are exceeded, device functionality should not be assumed, damage may occur and reliability may be affected.

THERMAL CHARACTERISTICS

Characteristic	Symbol	Max	Unit
Thermal Resistance, Junction-to-Case	R _{θJC}	1.76	°C/W



ON Semiconductor®

www.onsemi.com

**12 AMPERES
NPN SILICON
POWER TRANSISTORS
90 VOLTS, 85 WATTS**

SCHEMATIC

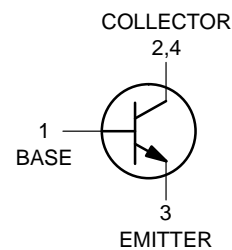

MARKING DIAGRAM

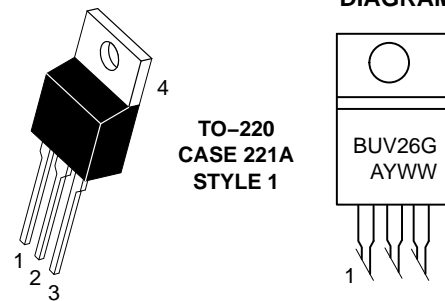

BUV26 = Device Code
 A = Assembly Location
 Y = Year
 WW = Work Week
 G = Pb-Free Package

ORDERING INFORMATION

Device	Package	Shipping
BUV26G	TO-220 (Pb-Free)	50 Units / Rail

*For additional information on our Pb-Free strategy and soldering details, please download the ON Semiconductor Soldering and Mounting Techniques Reference Manual, SOLDERRM/D.

BUV26

ELECTRICAL CHARACTERISTICS ($T_C = 25^\circ\text{C}$ unless otherwise noted)

Characteristic	Symbol	Min	Max	Unit
----------------	--------	-----	-----	------

OFF CHARACTERISTICS

Collector–Emitter Sustaining Voltage ($I_C = 200\text{ mA}$, $I_B = 0$, $L = 25\text{ mH}$)	$V_{CEO(sus)}$	90	–	Vdc
Collector Cutoff Current at Reverse Bias ($V_{CE} = 180\text{ V}$, $V_{BE} = -1.5\text{ V}$, $T_C = 125^\circ\text{C}$)	I_{CEX}	–	1.0	mAdc
Emitter Base Reverse Voltage ($I_E = 50\text{ mA}$)	V_{EBO}	7.0	30	V
Emitter Cutoff Current ($V_{EB} = 5.0\text{ V}$)	I_{EBO}	–	1.0	mAdc
Collector Cutoff Current ($V_{CE} = 180\text{ V}$, $R_{BE} = 50\ \Omega$, $T_C = 125^\circ\text{C}$)	I_{CER}	–	3.0	mAdc

ON CHARACTERISTICS

Collector–Emitter Saturation Voltage ($I_C = 6.0\text{ A}$, $I_B = 0.4\text{ A}$) ($I_C = 12\text{ A}$, $I_B = 1.2\text{ A}$)	$V_{CE(sat)}$	– –	0.6 1.5	Vdc
Base–Emitter Saturation Voltage ($I_C = 12\text{ A}$, $I_B = 1.2\text{ A}$)	$V_{BE(sat)}$	–	2.0	Vdc

SWITCHING CHARACTERISTICS (Resistive Load)

Turn On Time	$I_C = 12\text{ A}$, $I_B = 1.2\text{ A}$ $V_{CC} = 50\text{ V}$, $V_{BE} = 6.0\text{ V}$ $R_{B2} = 2.5\ \Omega$	t_{on}	–	0.6	μs
Storage Time		t_s	–	1.0	
Fall Time		t_f	–	0.15	

SWITCHING CHARACTERISTICS (Inductive Load)

Storage Time	$V_{CC} = 50\text{ V}$, $I_C = 12\text{ A}$ $I_{B(end)} = 1.2\text{ A}$, $V_B = 5.0\text{ V}$ $L_B = 0.5\ \mu\text{H}$, $T_J = 125^\circ\text{C}$	T_s	–	2.0	μs
Fall Time		T_f	–	.15	

Product parametric performance is indicated in the Electrical Characteristics for the listed test conditions, unless otherwise noted. Product performance may not be indicated by the Electrical Characteristics if operated under different conditions.

1. Pulse Test: Pulse width $\leq 300\ \mu\text{s}$; Duty cycle $\leq 2\%$.

BUV26

TYPICAL CHARACTERISTICS

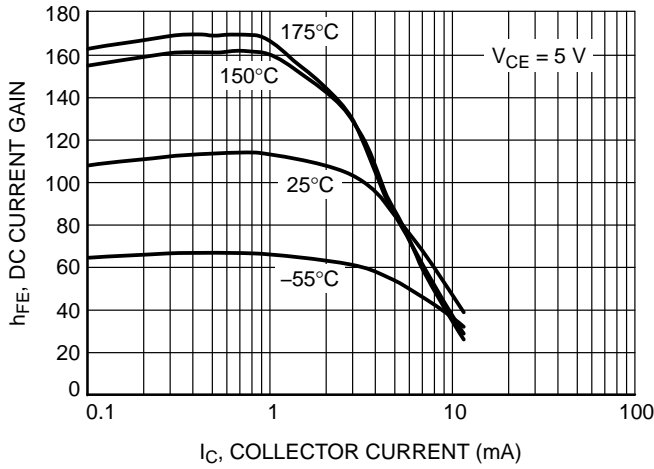

Figure 1. DC Current Gain

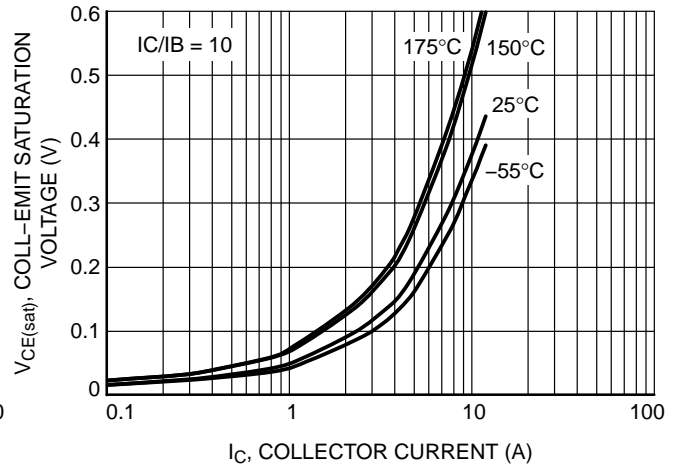

Figure 2. Collector-Emitter Saturation Voltage

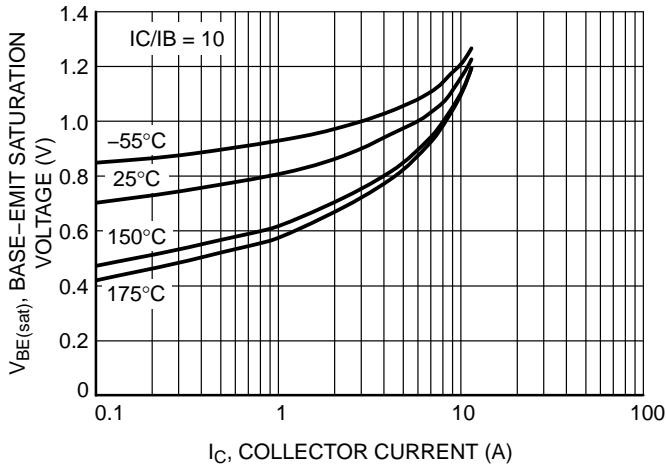

Figure 3. Base-Emitter Saturation Voltage

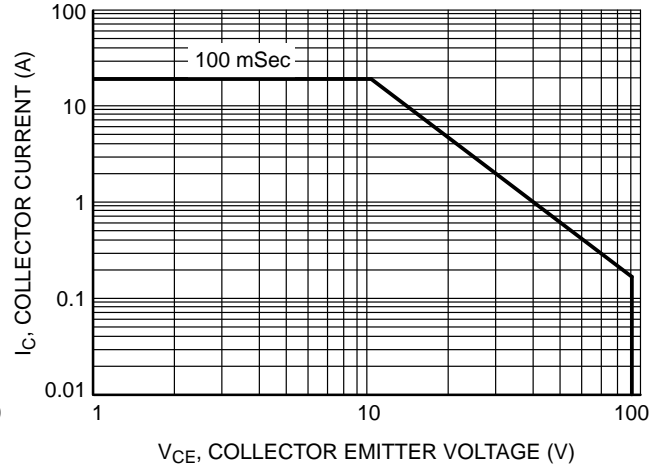
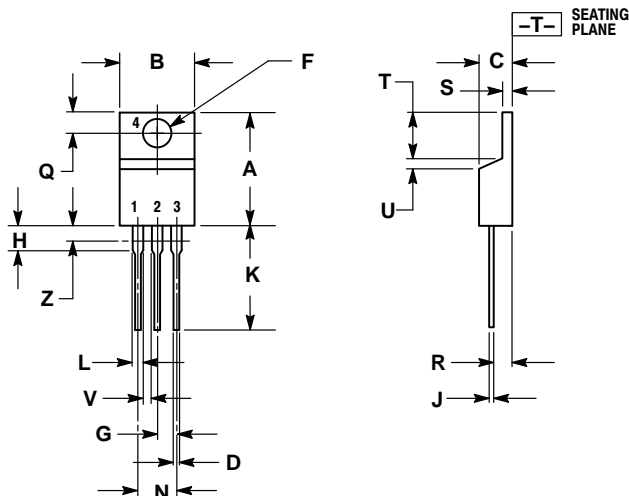

Figure 4. Safe Operating Area

BUV26

PACKAGE DIMENSIONS

TO-220
CASE 221A-09
ISSUE AH



NOTES:

1. DIMENSIONING AND TOLERANCING PER ANSI Y14.5M, 1982.
2. CONTROLLING DIMENSION: INCH.
3. DIMENSION Z DEFINES A ZONE WHERE ALL BODY AND LEAD IRREGULARITIES ARE ALLOWED.

DIM	INCHES		MILLIMETERS	
	MIN	MAX	MIN	MAX
A	0.570	0.620	14.48	15.75
B	0.380	0.415	9.66	10.53
C	0.160	0.190	4.07	4.83
D	0.025	0.038	0.64	0.96
F	0.142	0.161	3.61	4.09
G	0.095	0.105	2.42	2.66
H	0.110	0.161	2.80	4.10
J	0.014	0.024	0.36	0.61
K	0.500	0.562	12.70	14.27
L	0.045	0.060	1.15	1.52
N	0.190	0.210	4.83	5.33
Q	0.100	0.120	2.54	3.04
R	0.080	0.110	2.04	2.79
S	0.045	0.055	1.15	1.39
T	0.235	0.255	5.97	6.47
U	0.000	0.050	0.00	1.27
V	0.045	---	1.15	---
Z	---	0.080	---	2.04

STYLE 1:

1. BASE
2. COLLECTOR
3. EMITTER
4. COLLECTOR

ON Semiconductor and the  are registered trademarks of Semiconductor Components Industries, LLC (SCILLC) or its subsidiaries in the United States and/or other countries. SCILLC owns the rights to a number of patents, trademarks, copyrights, trade secrets, and other intellectual property. A listing of SCILLC's product/patent coverage may be accessed at www.onsemi.com/site/pdf/Patent-Marking.pdf. SCILLC reserves the right to make changes without further notice to any products herein. SCILLC makes no warranty, representation or guarantee regarding the suitability of its products for any particular purpose, nor does SCILLC assume any liability arising out of the application or use of any product or circuit, and specifically disclaims any and all liability, including without limitation special, consequential or incidental damages. "Typical" parameters which may be provided in SCILLC data sheets and/or specifications can and do vary in different applications and actual performance may vary over time. All operating parameters, including "Typicals" must be validated for each customer application by customer's technical experts. SCILLC does not convey any license under its patent rights nor the rights of others. SCILLC products are not designed, intended, or authorized for use as components in systems intended for surgical implant into the body, or other applications intended to support or sustain life, or for any other application in which the failure of the SCILLC product could create a situation where personal injury or death may occur. Should Buyer purchase or use SCILLC products for any such unintended or unauthorized application, Buyer shall indemnify and hold SCILLC and its officers, employees, subsidiaries, affiliates, and distributors harmless against all claims, costs, damages, and expenses, and reasonable attorney fees arising out of, directly or indirectly, any claim of personal injury or death associated with such unintended or unauthorized use, even if such claim alleges that SCILLC was negligent regarding the design or manufacture of the part. SCILLC is an Equal Opportunity/Affirmative Action Employer. This literature is subject to all applicable copyright laws and is not for resale in any manner.

PUBLICATION ORDERING INFORMATION

LITERATURE FULFILLMENT:

Literature Distribution Center for ON Semiconductor
P.O. Box 5163, Denver, Colorado 80217 USA
Phone: 303-675-2175 or 800-344-3860 Toll Free USA/Canada
Fax: 303-675-2176 or 800-344-3867 Toll Free USA/Canada
Email: orderlit@onsemi.com

N. American Technical Support: 800-282-9855 Toll Free
USA/Canada
Europe, Middle East and Africa Technical Support:
Phone: 421 33 790 2910
Japan Customer Focus Center
Phone: 81-3-5817-1050

ON Semiconductor Website: www.onsemi.com
Order Literature: <http://www.onsemi.com/orderlit>

For additional information, please contact your local Sales Representative

Mouser Electronics

Authorized Distributor

Click to View Pricing, Inventory, Delivery & Lifecycle Information:

[ON Semiconductor:](#)

[BUV26G](#)