

Features

- High reverse voltage (200 V)
- Low forward voltage drop
- High frequency operation

Description

The STPS60SM200C is a dual Schottky rectifier suited for high frequency switched-mode power supply.

Housed in TO-247, this device is especially suited for use in telecom base station SMPS, providing these applications with a good efficiency at both low and high load.

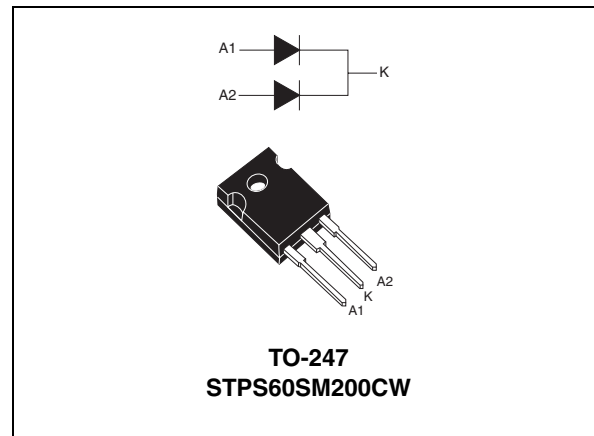

Table 1. Device summary

Symbol	Value
$I_{F(AV)}$	2 x 30 A
V_{RRM}	200 V
T_j (max)	175 °C
V_F (typ)	640 mV

1 Characteristics

Table 2. Absolute ratings (limiting values per diode at 25 °C, unless otherwise specified)

Symbol	Parameter		Value	Unit
V _{RRM}	Repetitive peak reverse voltage		200	V
I _{F(RMS)}	Forward current rms		50	A
I _{F(AV)}	Average forward current $\delta = 0.5$	Per diode, $\delta = 0.5$ T _c = 155 °C	30	A
		per device, $\delta = 0.5$ T _c = 150 °C	60	
I _{FSM}	Surge non repetitive forward current	t _p = 10 ms sinusoidal, T _c = 25 °C	500	A
T _{stg}	Storage temperature range		-65 to + 175	°C
T _j	Maximum operating junction temperature ⁽¹⁾		-40 to + 175	°C

1. $\frac{dP_{tot}}{dT_j} < \frac{1}{R_{th(j-a)}}$ condition to avoid thermal runaway for a diode on its own heatsink

Table 3. Thermal resistance

Symbol	Parameter		Value	Unit
R _{th(j-c)}	Junction to case	Per diode	0.7	°C/W
		Total	0.5	
R _{th(c)}	Coupling		0.3	

When the two diodes 1 and 2 are used simultaneously:
 $\Delta T_j(\text{diode 1}) = P(\text{diode 1}) \times R_{th(j-c)}(\text{Per diode}) + P(\text{diode 2}) \times R_{th(c)}$

Table 4. Static electrical characteristics (per diode)

Symbol	Parameter	Test conditions		Min.	Typ.	Max.	Unit
I _R ⁽¹⁾	Reverse leakage current	T _j = 25 °C	V _R = V _{RRM}			0.05	mA
		T _j = 125 °C			6	13	
V _F ⁽²⁾	Forward voltage drop	T _j = 25 °C	I _F = 7.5 A		0.67	0.70	V
		T _j = 125 °C			0.51	0.55	
		T _j = 25 °C	I _F = 15 A		0.73	0.77	
		T _j = 125 °C			0.57	0.61	
		T _j = 25 °C	I _F = 30 A		0.79	0.83	
		T _j = 125 °C			0.64	0.69	

1. Pulse test: t_p = 5 ms, $\delta < 2\%$
2. Pulse test: t_p = 380 μ s, $\delta < 2\%$

To evaluate the conduction losses use the following equation:

$$P = 0.58 \times I_{F(AV)} + 0.0037 \times I_{F(RMS)}^2$$

Figure 1. Average forward power dissipation versus average forward current (per diode)

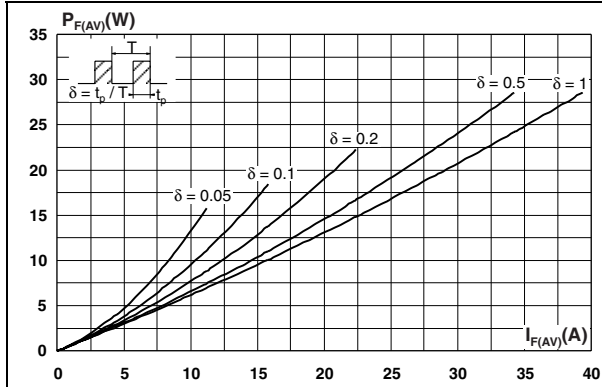

Figure 2. Average forward current versus ambient temperature ($\delta = 0.5$)

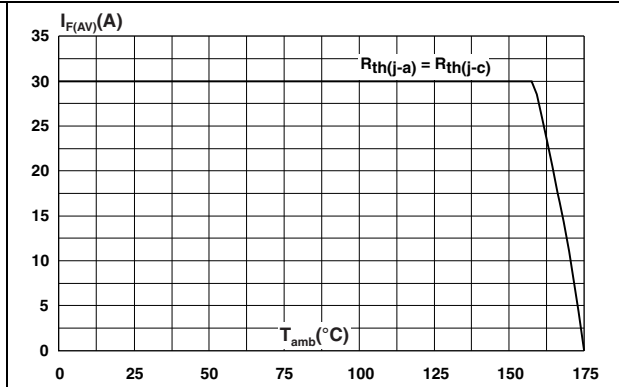

Figure 3. Non repetitive surge peak forward current versus overload duration (maximum values, per diode)

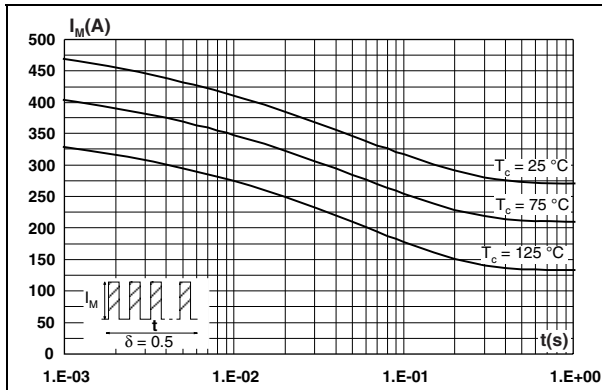

Figure 4. Relative variation of thermal impedance junction to case versus pulse duration

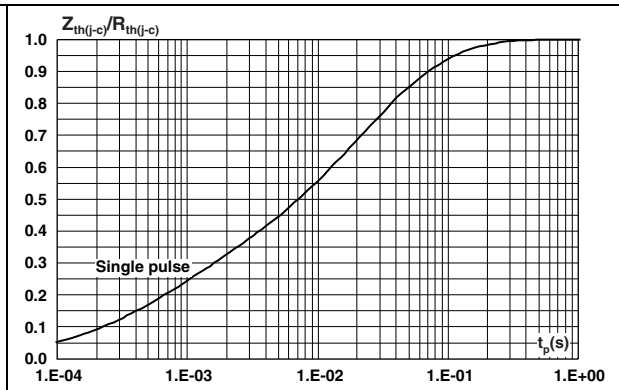

Figure 5. Reverse leakage current versus reverse voltage applied (typical values, per diode)

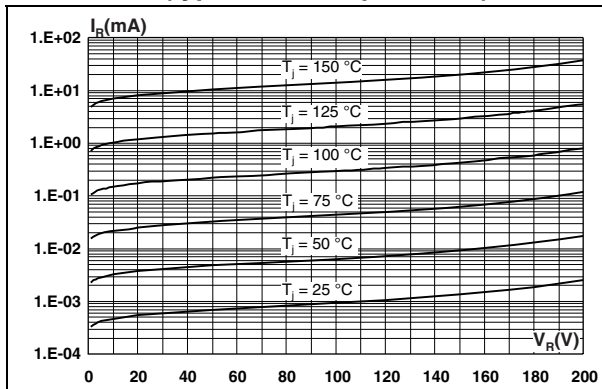

Figure 6. Junction capacitance versus reverse voltage applied (typical values, per diode)

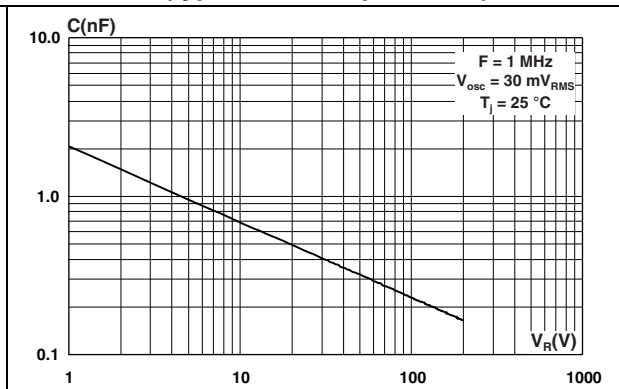

Figure 7. Forward voltage drop versus forward current (per diode, low level)

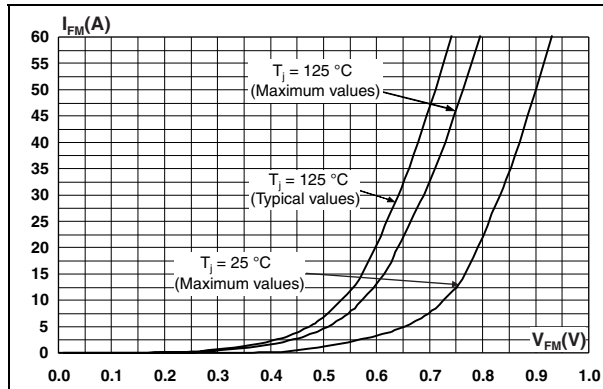
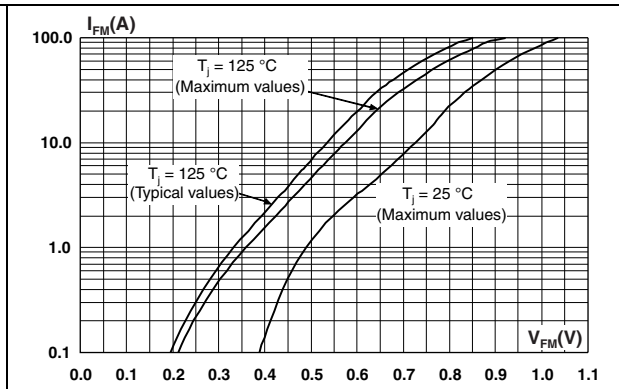

Figure 8. Forward voltage drop versus forward current (per diode, high level)



2 Package information

- Epoxy meets UL94, V0
- Cooling method: by conduction (C)
- Recommended torque value: 0.55 to 1.0 N·m

In order to meet environmental requirements, ST offers these devices in different grades of ECOPACK® packages, depending on their level of environmental compliance. ECOPACK® specifications, grade definitions and product status are available at: www.st.com. ECOPACK® is an ST trademark.

Table 5. TO-247 dimensions

Ref.	Dimensions			
	Millimeters		Inches	
	Min.	Max.	Min.	Max.
A	4.85	5.16	0.191	0.203
D	2.20	2.60	0.086	0.102
E	0.40	0.80	0.015	0.031
F	1.00	1.40	0.039	0.055
F1	3.00 typ.		0.118 typ.	
F2	2.00 typ.		0.079 typ.	
F3	1.90	2.40	0.075	0.094
F4	3.00	3.40	0.118	0.134
G	10.90 typ.		0.429 typ.	
H	15.45	16.03	0.608	0.631
L	19.85	21.09	0.781	0.830
L1	3.70	4.30	0.146	0.169
L2	18.30	19.13	0.720	0.753
L3	14.20	20.30	0.559	0.799
L4	34.05	41.38	1.341	1.629
L5	5.35	6.30	0.211	0.248
M	2.00	3.00	0.079	0.118
V	5° typ.		5° typ.	
V2	60° typ.		60° typ.	
Dia.	3.55	3.65	0.140	0.144

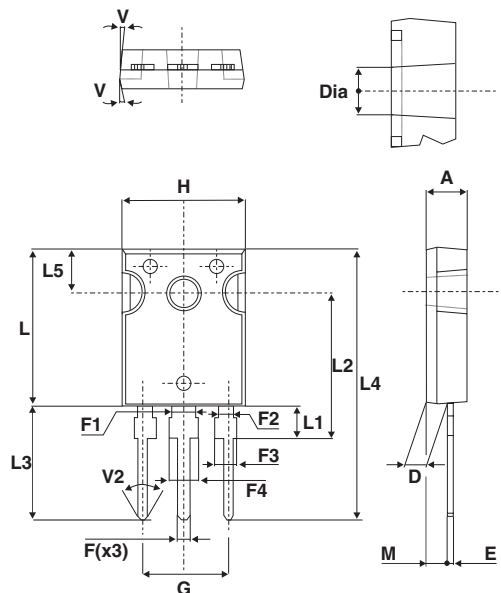

3 Ordering information

Table 6. Ordering information

Order code	Marking	Package	Weight	Base qty	Delivery mode
STPS60SM200CW	STPS60SM200CW	TO-247	4.45 g	30	Tube

4 Revision history

Table 7. Document revision history

Date	Revision	Changes
17-May-2011	1	First issue.

Please Read Carefully:

Information in this document is provided solely in connection with ST products. STMicroelectronics NV and its subsidiaries ("ST") reserve the right to make changes, corrections, modifications or improvements, to this document, and the products and services described herein at any time, without notice.

All ST products are sold pursuant to ST's terms and conditions of sale.

Purchasers are solely responsible for the choice, selection and use of the ST products and services described herein, and ST assumes no liability whatsoever relating to the choice, selection or use of the ST products and services described herein.

No license, express or implied, by estoppel or otherwise, to any intellectual property rights is granted under this document. If any part of this document refers to any third party products or services it shall not be deemed a license grant by ST for the use of such third party products or services, or any intellectual property contained therein or considered as a warranty covering the use in any manner whatsoever of such third party products or services or any intellectual property contained therein.

UNLESS OTHERWISE SET FORTH IN ST'S TERMS AND CONDITIONS OF SALE ST DISCLAIMS ANY EXPRESS OR IMPLIED WARRANTY WITH RESPECT TO THE USE AND/OR SALE OF ST PRODUCTS INCLUDING WITHOUT LIMITATION IMPLIED WARRANTIES OF MERCHANTABILITY, FITNESS FOR A PARTICULAR PURPOSE (AND THEIR EQUIVALENTS UNDER THE LAWS OF ANY JURISDICTION), OR INFRINGEMENT OF ANY PATENT, COPYRIGHT OR OTHER INTELLECTUAL PROPERTY RIGHT.

UNLESS EXPRESSLY APPROVED IN WRITING BY AN AUTHORIZED ST REPRESENTATIVE, ST PRODUCTS ARE NOT RECOMMENDED, AUTHORIZED OR WARRANTED FOR USE IN MILITARY, AIR CRAFT, SPACE, LIFE SAVING, OR LIFE SUSTAINING APPLICATIONS, NOR IN PRODUCTS OR SYSTEMS WHERE FAILURE OR MALFUNCTION MAY RESULT IN PERSONAL INJURY, DEATH, OR SEVERE PROPERTY OR ENVIRONMENTAL DAMAGE. ST PRODUCTS WHICH ARE NOT SPECIFIED AS "AUTOMOTIVE GRADE" MAY ONLY BE USED IN AUTOMOTIVE APPLICATIONS AT USER'S OWN RISK.

Resale of ST products with provisions different from the statements and/or technical features set forth in this document shall immediately void any warranty granted by ST for the ST product or service described herein and shall not create or extend in any manner whatsoever, any liability of ST.

ST and the ST logo are trademarks or registered trademarks of ST in various countries.

Information in this document supersedes and replaces all information previously supplied.

The ST logo is a registered trademark of STMicroelectronics. All other names are the property of their respective owners.

© 2011 STMicroelectronics - All rights reserved

STMicroelectronics group of companies

Australia - Belgium - Brazil - Canada - China - Czech Republic - Finland - France - Germany - Hong Kong - India - Israel - Italy - Japan - Malaysia - Malta - Morocco - Philippines - Singapore - Spain - Sweden - Switzerland - United Kingdom - United States of America

www.st.com

Mouser Electronics

Authorized Distributor

Click to View Pricing, Inventory, Delivery & Lifecycle Information:

[STMicroelectronics:](#)

[STPS60SM200CW](#)