

MODULAR CONNECTORS

Dip Type

CL 222 TM

Straight Dip Type

TM3R-6-*(50)

CL No.	Part No.	RoHS
222-0114-3-50	TM3R-66(50)	YES
222-0071-2-50	TM3R-64(50)	

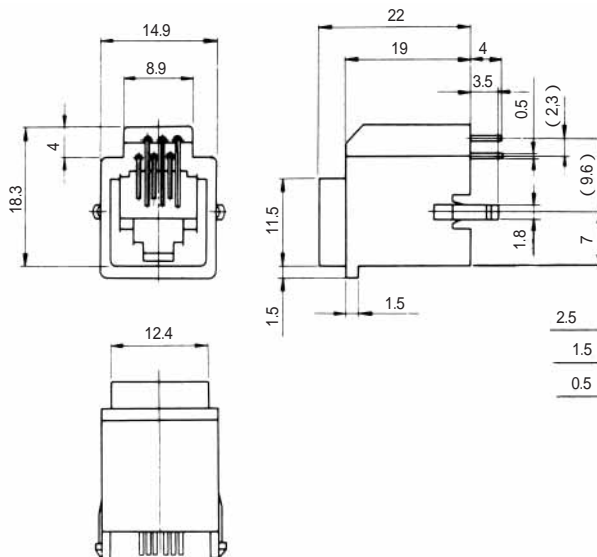
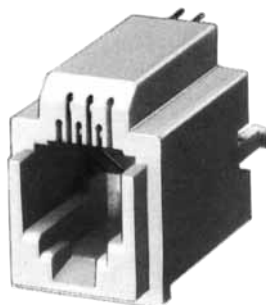

PCB mounting hole layout
(Connector mounting side)

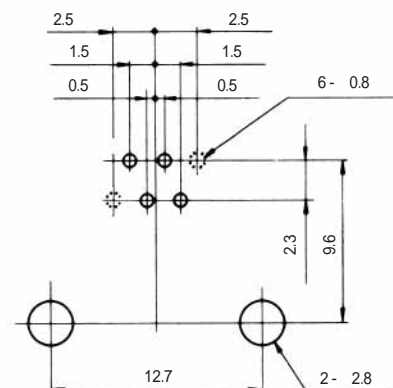

Note1: Standard finish color is vanilla white.

Note2: The drawing is shown sample of TM3R-66(50).

TM3RA-**(50)

CL No.	Part No.	A	B	C	RoHS
222-0521-7-50	TM3RA-44(50)	12.9	6.9	10.4	YES
222-0567-8-50	TM3RA-62(50)	14.9	8.9	12.4	
222-0584-7-50	TM3RA-64(50)	14.9	8.9	12.4	
222-0770-1-50	TM3RA-66(50)	14.9	8.9	12.4	

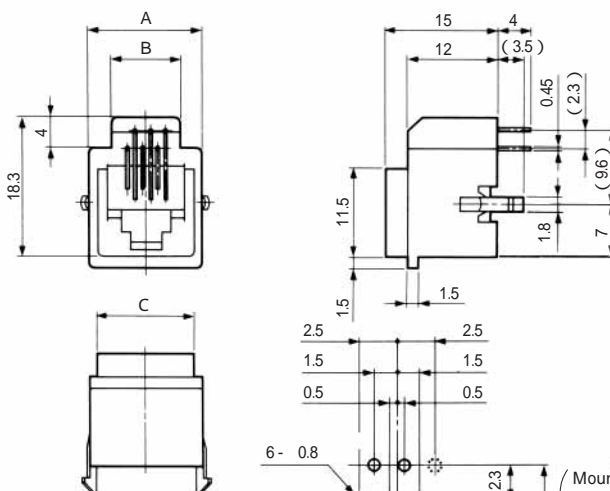
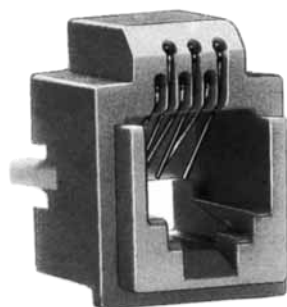

PCB mounting hole layout
(Connector mounting side)

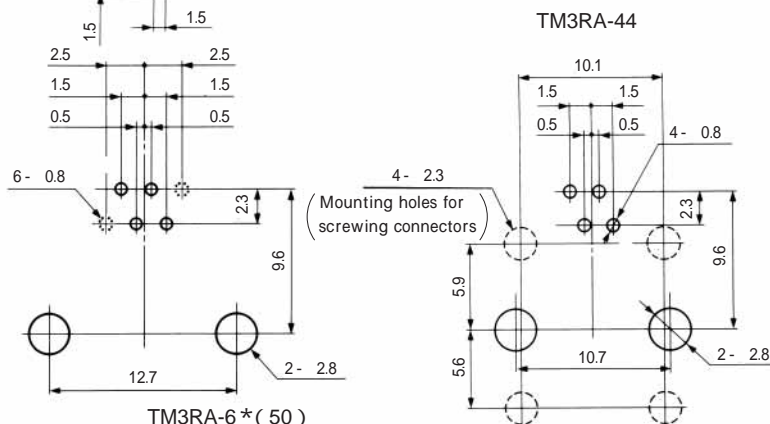

Note1: Standard finish color is vanilla white.

Note2: The drawing is shown sample of TM3RA-66(50).

MODULAR CONNECTORS

CL 222 TM

TM3RA-88(50)

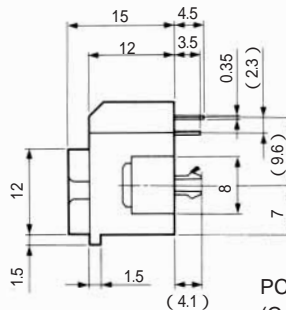
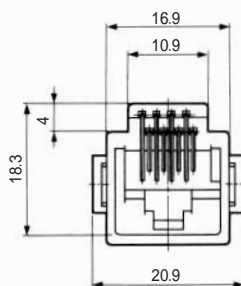
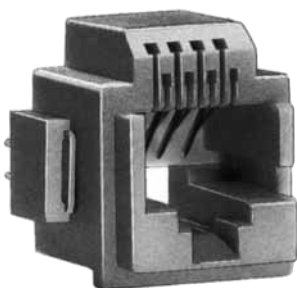

PCB mounting hole layout
(Connector mounting side)

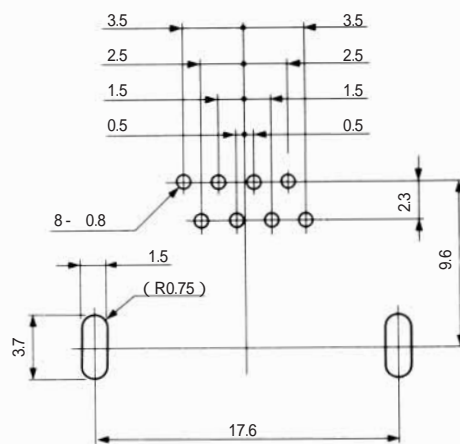

CL No.	Part No.	RoHS
222-1012-9-50	TM3RA-88(50)	YES

Note1: (50)Stick packaging... 27 units.

Note2: Standard finish color is vanilla white.

TM3RA1- * *(* *)

CL No.	Part No.	A	B	C	D	RoHS
222-1374-0-67	TM3RA1-44(67)	12.9	6.9	10.4	11	YES
222-1375-2-60	TM3RA1-62(60)	14.9	8.9	12.4	13	
222-1376-5-67	TM3RA1-64(67)	14.9	8.9	12.4	13	
222-1377-8-67	TM3RA1-66(67)	14.9	8.9	12.4	13	

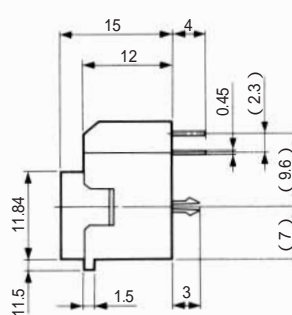
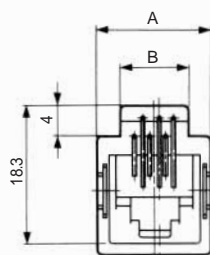

PCB mounting hole layout
(Connector mounting side)

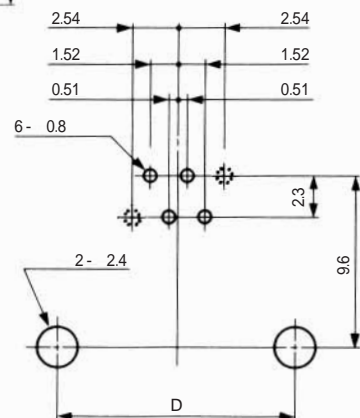

Note1:(67)Stick packaging, type 44 42 units.
 type 6 * ... 36 units.

Note2: Standard finish color is black.

Note3: The drawing is shown sample of TM3RA1-66(67).

MODULAR CONNECTORS

CL 222 TM

Gang-Jacks Straight Dip Type

TM2RE-06 * *(50)

CL No.	Part No.	RoHS
222-1286-4-50	TM2RE-0602(50)	YES
222-1391-9-50	TM2RE-0604(50)	
222-1422-0-50	TM2RE-0606(50)	

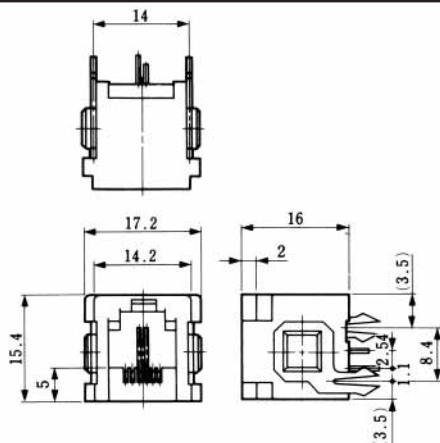
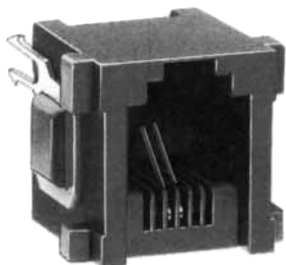

PCB mounting hole layout
(Connector mounting side)

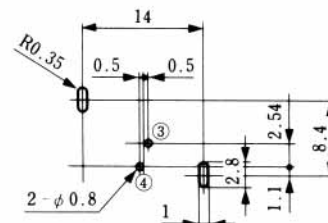

TM2RE-0602(50)

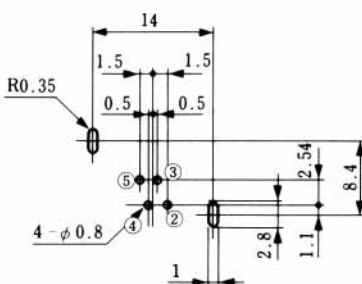

TM2RE-0604(50)

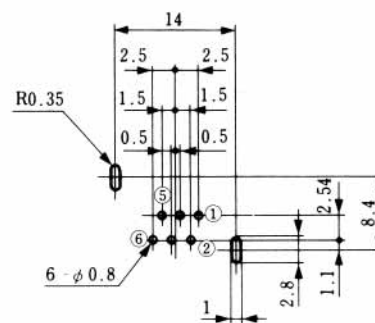

TM2RE-0606(50)

Note 1: Standard finish color is gray.

Note 2: The drawing is shown sample of TM2RE-0602(50).

TM2RE-12 * *(50)

CL No.	Part No.	RoHS
222-0592-5-50	TM2RE-1204(50)	YES
222-0756-0-50	TM2RE-1208(50)	
222-0757-3-50	TM2RE-1212(50)	

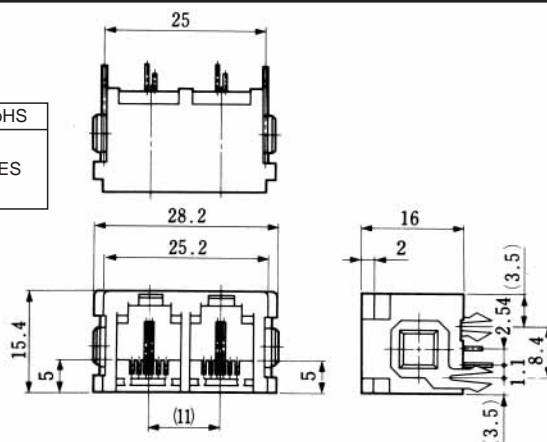
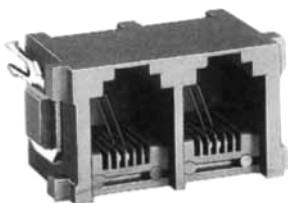

PCB mounting hole layout
(Connector mounting side)

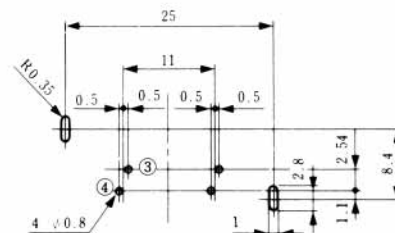

TM2RE-1204(50)

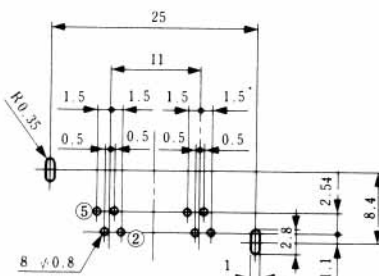

TM2RE-1208(50)

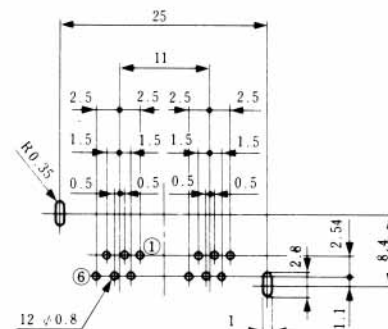

TM2RE-1212(50)

Note 1: Standard finish color is gray.

Note 2: The drawing is shown sample of TM2RE-1204(50).

MODULAR CONNECTORS

CL 222 TM

TM2RE-18 * *(50)

CL No.	Part No.	RoHS
222-0591-2-50	TM2RE-1806(50)	YES
222-0753-2-50	TM2RE-1812(50)	
222-0796-5-50	TM2RE-1818(50)	



PCB mounting hole layout
(Connector mounting side)

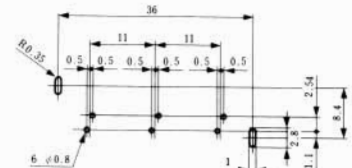
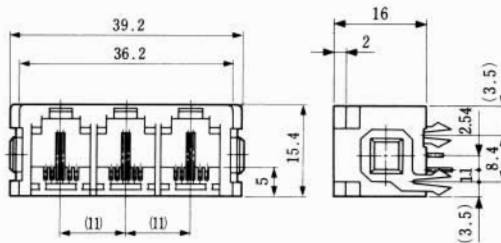

TM2RE-1806(50)

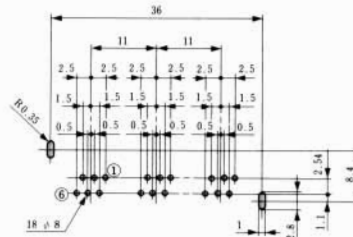

TM2RE-1818(50)

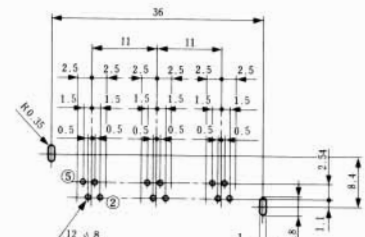

TM2RE-1812(50)

Note 1: Standard finish color is gray.

Note 2: The drawing is shown sample of TM2RE-1806(50).

TM2RE-24 * *(50)

CL No.	Part No.	RoHS
222-0797-8-50	TM2RE-2408(50)	YES
222-0590-0-50	TM2RE-2416(50)	
222-0751-7-50	TM2RE-2424(50)	

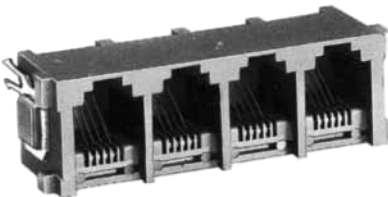

PCB mounting hole layout (Connector mounting side)

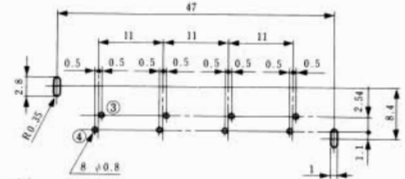
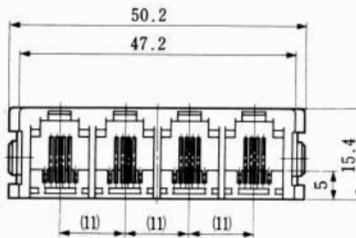
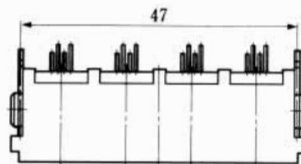

TM2RE-2408(50)

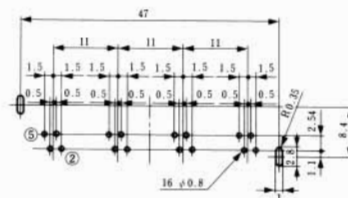

TM2RE-2416(50)

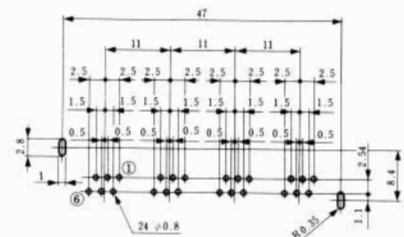

TM2RE-2424(50)

Note 1: Standard finish color is gray.

Note 2: The drawing is shown sample of TM2RE-2416(50).

MODULAR CONNECTORS

CL 222 TM

TM3RA1-1010A(50)

CL No.	Part No.	RoHS
222-2526-1-50	TM3RA1-1010A(50)	YES

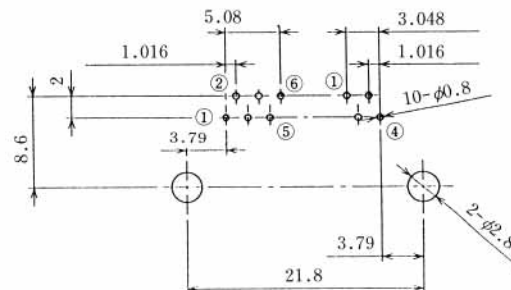
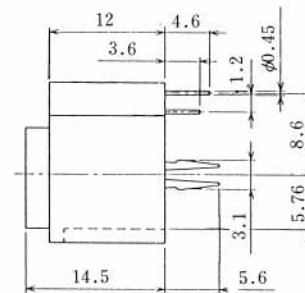
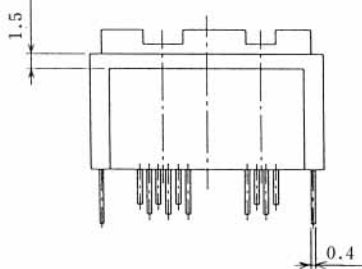
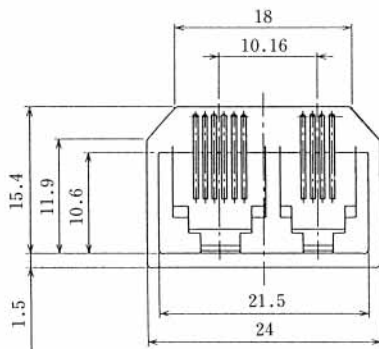
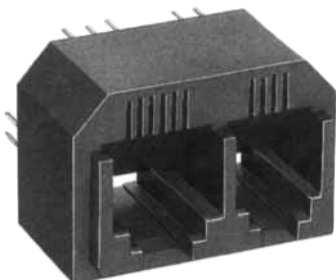

PCB mounting hole layout
(Connector mounting side)

Note : Standard finish color is black.

TM3RB1-1010(50)

CL No.	Part No.	RoHS
222-2598-2-50	TM3RB1-1010(50)	YES

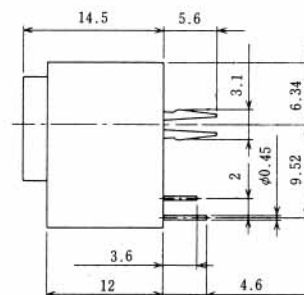
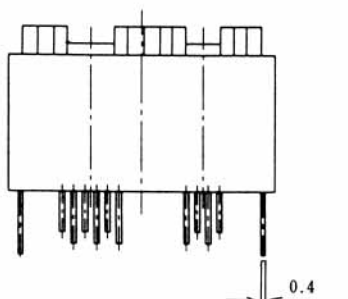
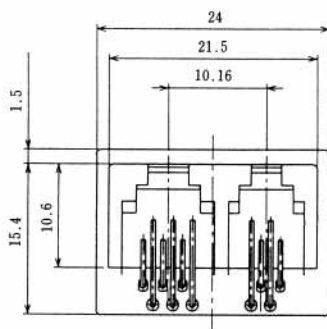
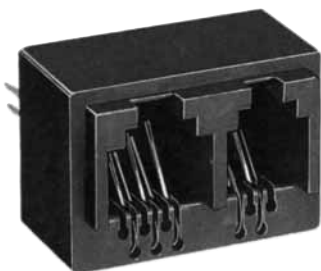

PCB mounting hole layout
(Connector mounting side)

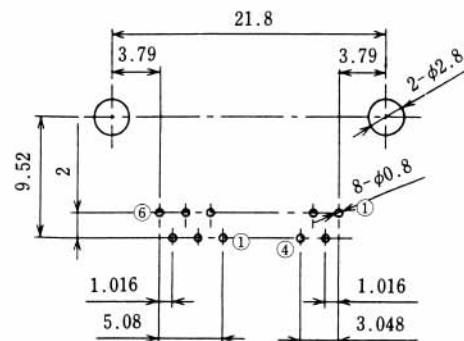

Note : Standard finish color is black.

Mouser Electronics

Authorized Distributor

Click to View Pricing, Inventory, Delivery & Lifecycle Information:

[Hirose Electric:](#)

[TM3R-64\(50\)](#) [TM5RA-44\(50\)](#) [TM5RA-66\(50\)](#) [TM5RA-64\(50\)](#) [TM3R-66\(50\)](#) [TM5RC-44\(50\)](#) [TM5RC-66\(50\)](#)
[TM5RC-64\(50\)](#) [TM5RC-88\(50\)](#) [TM5RF-44\(50\)](#) [TM3RA-44\(50\)](#) [TM5RE1-44\(20\)](#) [TM5RE1-62\(20\)](#) [TM5RE1-64\(20\)](#)
[TM5RE1-64\(21\)](#) [TM5RE1-66\(20\)](#) [TM3RA-62\(50\)](#) [TM3RA-64\(50\)](#) [TM2RE-2416\(50\)](#) [TM2RE-1806\(50\)](#) [TM2RE-1204\(50\)](#) [TM2REA-1212\(50\)](#) [TM2REA-1818\(50\)](#) [TM2REA-2416\(50\)](#) [TM2REA-2424\(50\)](#) [TM2RE-2424\(50\)](#) [TM2RE-1208\(50\)](#) [TM2RE-1212\(50\)](#) [TM3RA-66\(50\)](#) [TM2RE-1818\(50\)](#) [TM2RE-2408\(50\)](#) [TM2REA-1812\(50\)](#) [TM2REA-1208\(50\)](#) [TM2REA-2408\(50\)](#) [TM2REA-1806\(50\)](#) [TM2REA-1204\(50\)](#) [TM3RA-88\(50\)](#) [TM5RJ-64\(50\)](#) [TM5RJ-66\(50\)](#) [TM5RJ-88\(50\)](#) [TM5RJ-62\(50\)](#) [TM5RJ-62\(52\)](#) [TM5RJ1-88\(50\)](#) [TM5RE2-44\(20\)](#) [TM5RE2-64\(20\)](#) [TM5RE2-64\(60\)](#) [TM5RE2-62\(20\)](#) [TM5RE2-66\(20\)](#) [TM5RE2-66\(50\)](#) [TM5RF1-44\(50\)](#) [TM5RF1-44\(60\)](#) [TM5RF1-44\(71\)](#) [TM5RJ1-62\(50\)](#) [TM5RJ1-64\(50\)](#) [TM5RJ1-64\(52\)](#) [TM5RJ1-66\(50\)](#) [TM2REA-0602\(50\)](#) [TM2RE-0602\(50\)](#) [TM5RJ3-44\(50\)](#) [TM5RJ1-4848\(50\)](#) [TM3RA1-44\(50\)](#) [TM3RA1-44\(60\)](#) [TM3RA1-44\(67\)](#) [TM3RA1-62\(50\)](#) [TM3RA1-62\(60\)](#) [TM3RA1-64\(50\)](#) [TM3RA1-64\(60\)](#) [TM3RA1-64\(67\)](#) [TM3RA1-66\(50\)](#) [TM3RA1-66\(51\)](#) [TM3RA1-66\(60\)](#) [TM3RA1-66\(67\)](#) [TM2RE-0604\(50\)](#) [TM5RE3-44\(20\)](#) [TM5RE3-62\(20\)](#) [TM5RF-66](#) [TM5RF-66\(50\)](#) [TM2RE-0606\(50\)](#) [TM5RE3-64\(20\)](#) [TM5RE3-66\(20\)](#) [TM5RJ2-44\(50\)](#) [TM5RJ2-64](#) [TM5RJ2-64\(50\)](#) [TM5RJ2-64\(52\)](#) [TM5RJ2-66\(50\)](#) [TM5RJ2-66\(52\)](#) [TM5RJ2-88\(50\)](#) [TM5RJ3-64\(50\)](#) [TM5RJ3-64\(51\)](#) [TM5RJ3-66\(50\)](#) [TM5RJ3-66\(51\)](#) [TM5RJ3-88\(50\)](#) [TM5RJ3-88\(51\)](#) [TM5RJ3-88\(52\)](#) [TM2REA-0604\(50\)](#) [TM2REA-0606\(50\)](#) [TM5RJ2-62\(50\)](#) [TM5RJ2-62\(51\)](#) [TM5RJ2-62\(52\)](#) [TM5RJ3-62\(50\)](#)