

REVISIONS				
P	LTR	DESCRIPTION	DATE	APPV
F1		REVISED PER ECO-16-011475	11AUG2016	NK JO

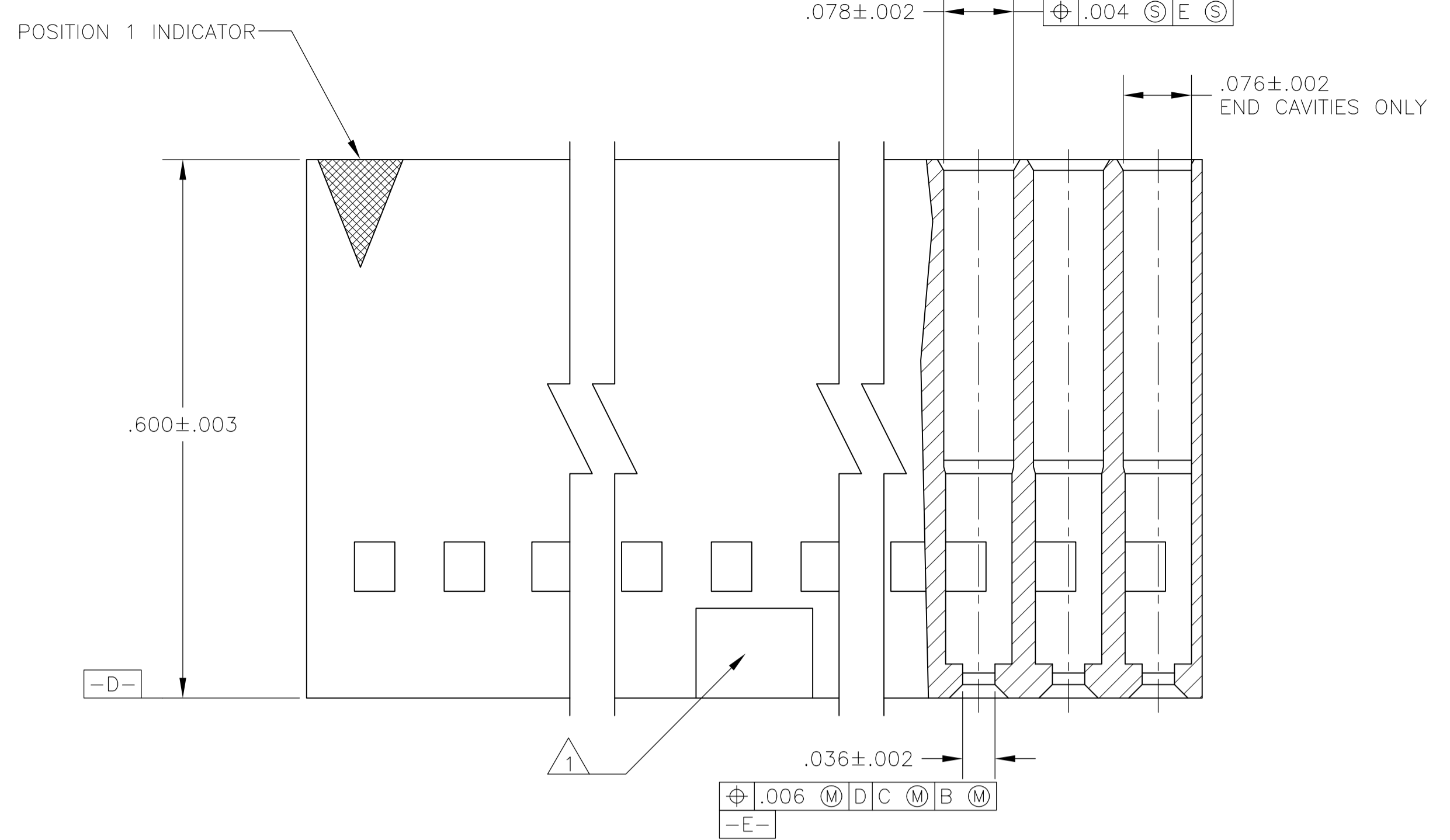

- 1 VOID CORING PERMISSIBLE IN POLARIZATION BAR.
- 2 EJECTOR FEATURES AT MOLDER'S DISCRETION (QUANTITY AND LOCATION).

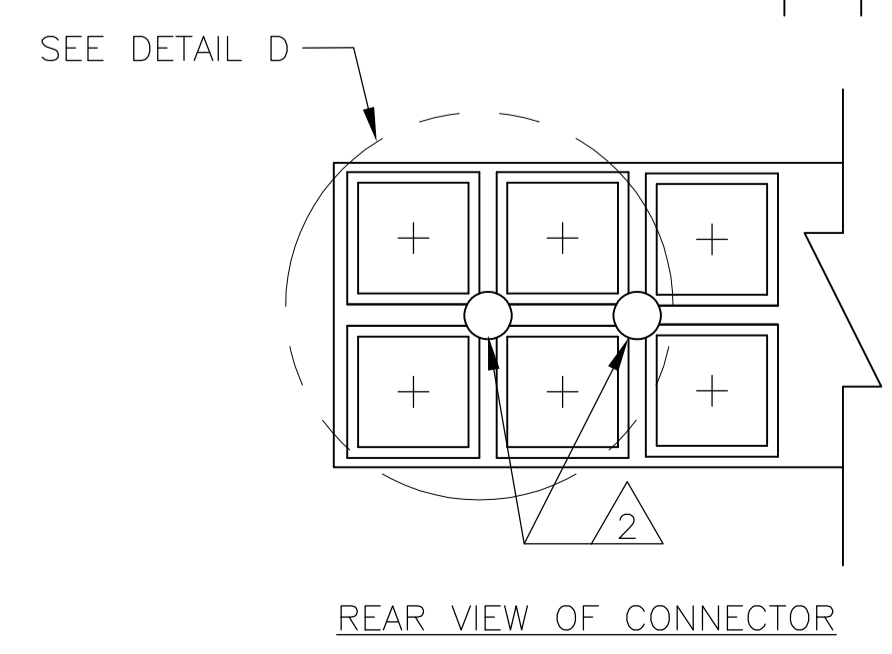
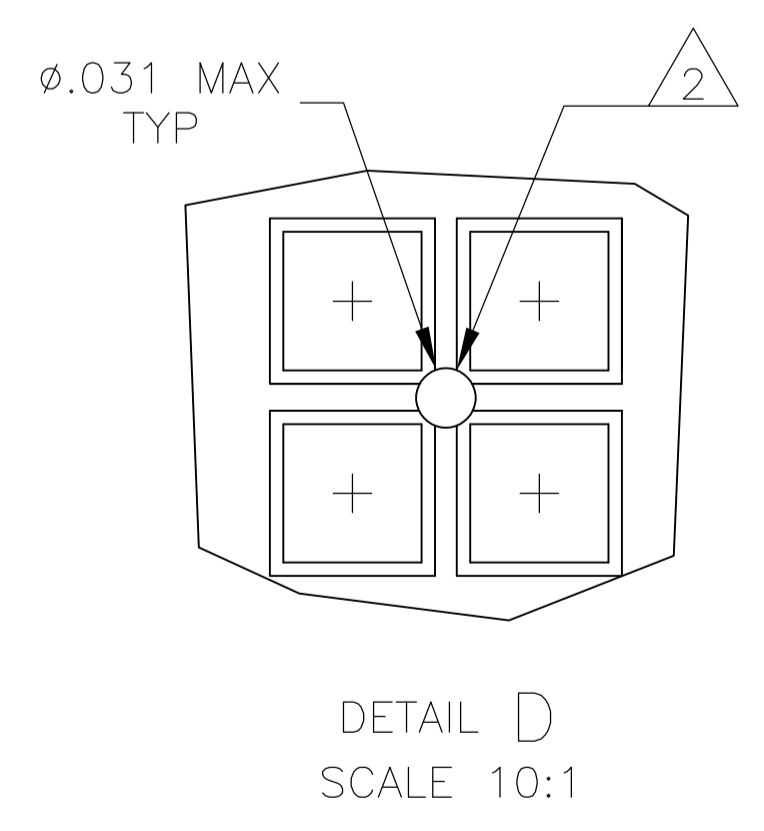
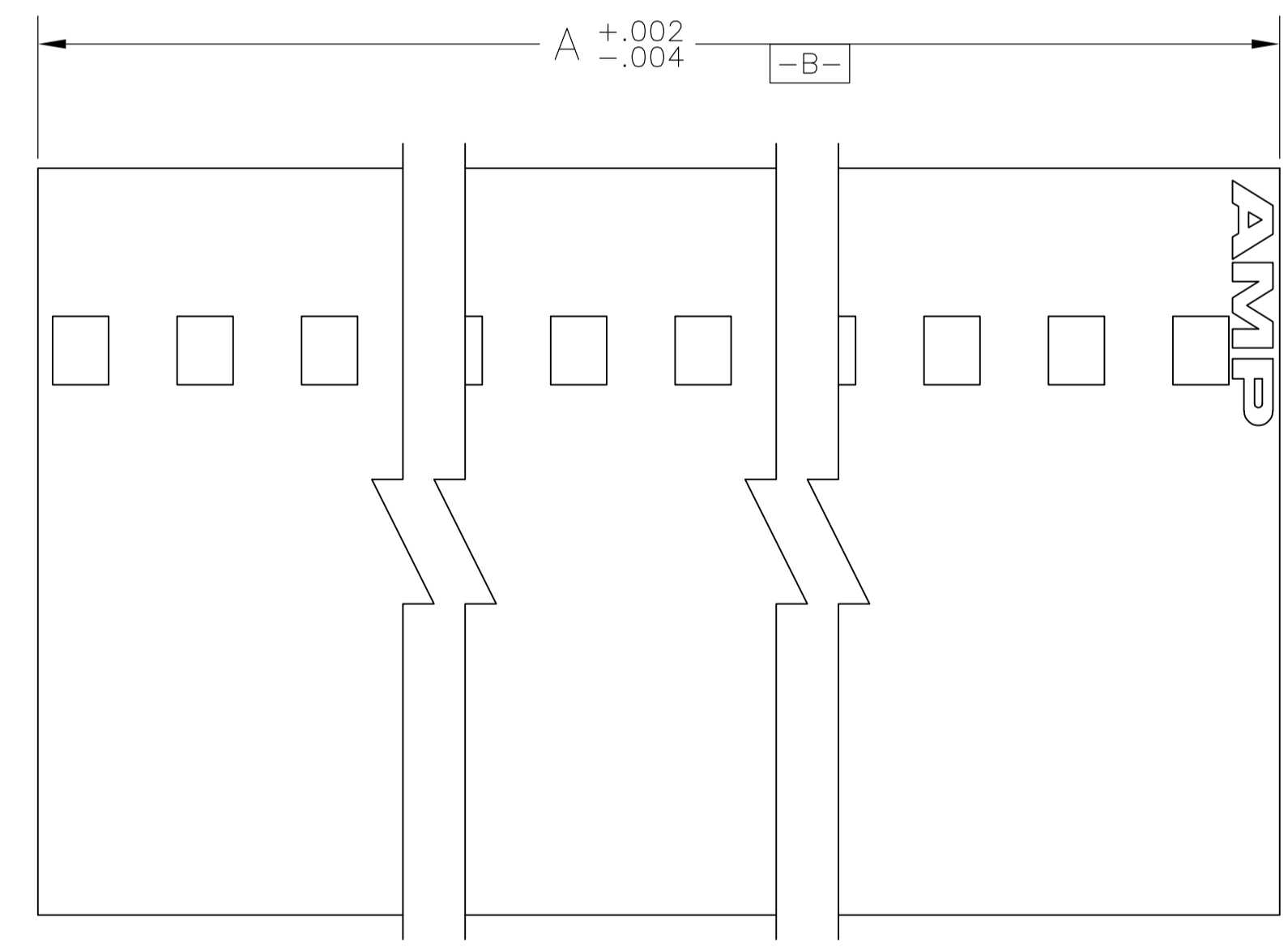
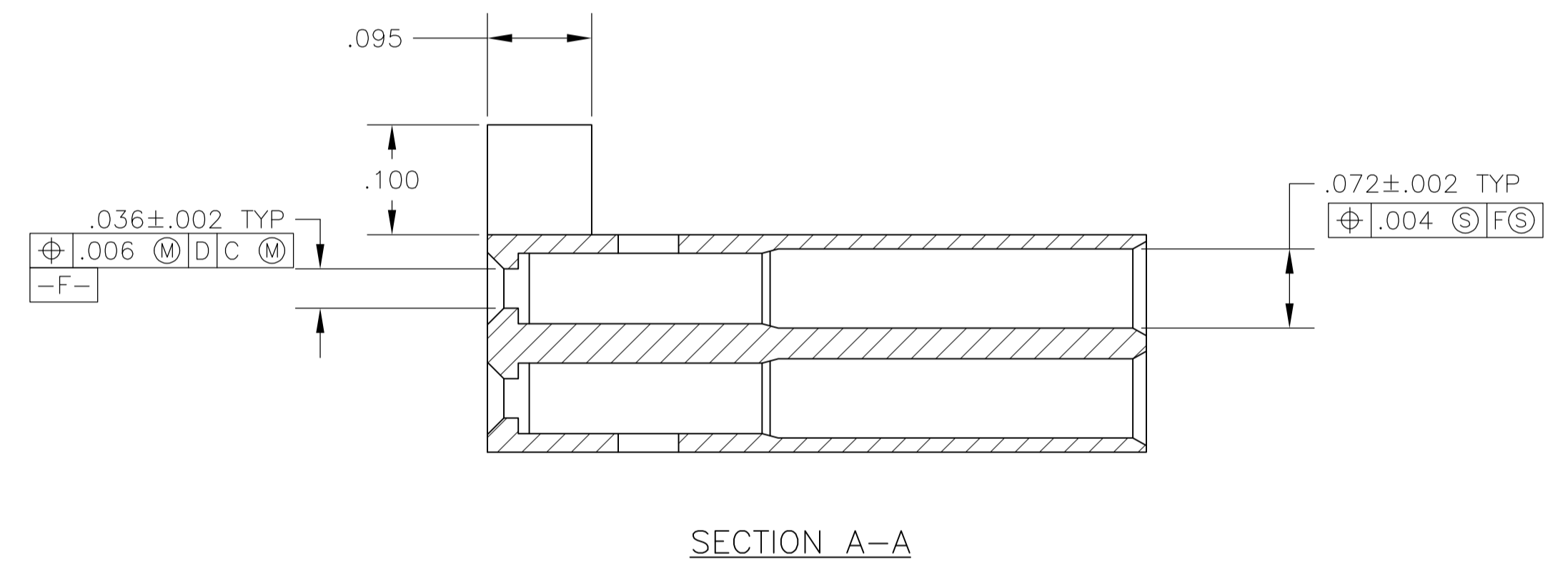
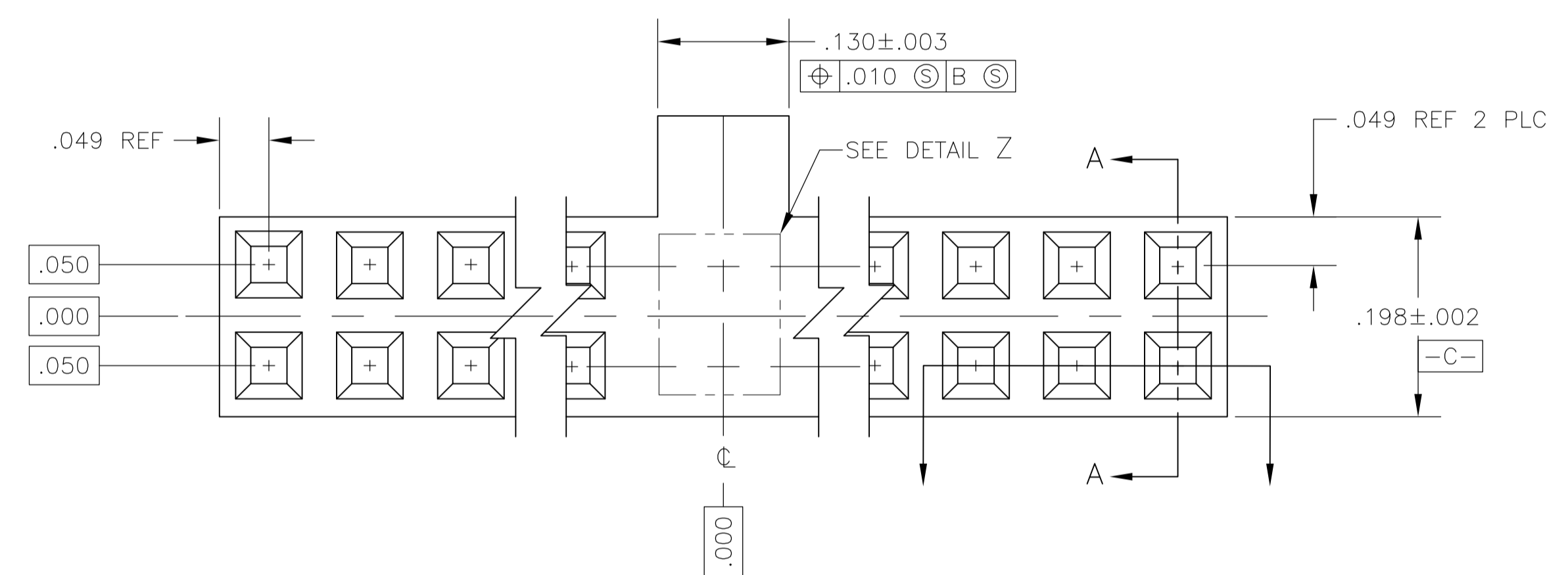
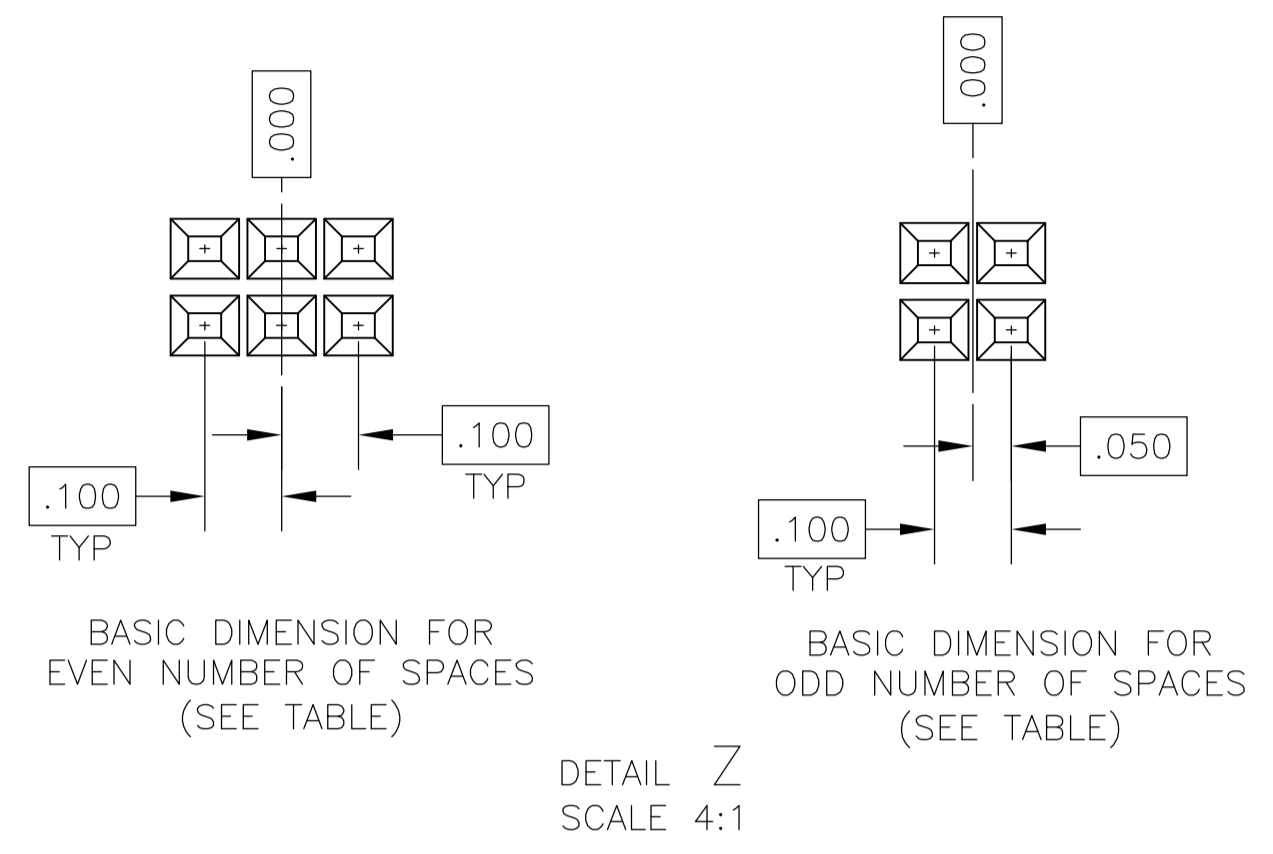

1.798	17	36	1-104483-4
2.498	24	50	1-104483-3
.598	5	12	1-104483-2
.498	4	10	1-104483-1
2.598	25	52	1-104483-0
.698	6	14	104483-9
3.198	31	64	104483-8
2.698	26	54	104483-7
1.898	18	38	104483-6
1.498	14	30	104483-5
1.298	12	26	104483-4
.998	9	20	104483-3
.898	8	18	104483-2
.398	3	8	104483-1

A	NO OF SP	NO OF POSN	PART NUMBER

THIS DRAWING IS A CONTROLLED DOCUMENT.

SCOTT A. SHUEY 17MAY89
H. MOLL 18MAY89
R. FLICKER 18MAY89

TE Connectivity

RCPT HSG, DBL ROW, PLZD, .100x.100 CL, SHORT PT, AMPMODU

SIZE: A1 CAGE CODE: 00779 DRAWING NO: 104483

SCALE: 8:1 SHEET: 1 OF 1 REV: F1

Mouser Electronics

Authorized Distributor

Click to View Pricing, Inventory, Delivery & Lifecycle Information:

[TE Connectivity:](#)

[104483-7](#)