



Is Now Part of



**ON Semiconductor®**

To learn more about ON Semiconductor, please visit our website at  
[www.onsemi.com](http://www.onsemi.com)

Please note: As part of the Fairchild Semiconductor integration, some of the Fairchild orderable part numbers will need to change in order to meet ON Semiconductor's system requirements. Since the ON Semiconductor product management systems do not have the ability to manage part nomenclature that utilizes an underscore (\_), the underscore (\_) in the Fairchild part numbers will be changed to a dash (-). This document may contain device numbers with an underscore (\_). Please check the ON Semiconductor website to verify the updated device numbers. The most current and up-to-date ordering information can be found at [www.onsemi.com](http://www.onsemi.com). Please email any questions regarding the system integration to [Fairchild\\_questions@onsemi.com](mailto:Fairchild_questions@onsemi.com).

ON Semiconductor and the ON Semiconductor logo are trademarks of Semiconductor Components Industries, LLC dba ON Semiconductor or its subsidiaries in the United States and/or other countries. ON Semiconductor owns the rights to a number of patents, trademarks, copyrights, trade secrets, and other intellectual property. A listing of ON Semiconductor's product/patent coverage may be accessed at [www.onsemi.com/site/pdf/Patent-Marking.pdf](http://www.onsemi.com/site/pdf/Patent-Marking.pdf). ON Semiconductor reserves the right to make changes without further notice to any products herein. ON Semiconductor makes no warranty, representation or guarantee regarding the suitability of its products for any particular purpose, nor does ON Semiconductor assume any liability arising out of the application or use of any product or circuit, and specifically disclaims any and all liability, including without limitation special, consequential or incidental damages. Buyer is responsible for its products and applications using ON Semiconductor products, including compliance with all laws, regulations and safety requirements or standards, regardless of any support or applications information provided by ON Semiconductor. "Typical" parameters which may be provided in ON Semiconductor data sheets and/or specifications can and do vary in different applications and actual performance may vary over time. All operating parameters, including "Typicals" must be validated for each customer application by customer's technical experts. ON Semiconductor does not convey any license under its patent rights nor the rights of others. ON Semiconductor products are not designed, intended, or authorized for use as a critical component in life support systems or any FDA Class 3 medical devices or medical devices with a same or similar classification in a foreign jurisdiction or any devices intended for implantation in the human body. Should Buyer purchase or use ON Semiconductor products for any such unintended or unauthorized application, Buyer shall indemnify and hold ON Semiconductor and its officers, employees, subsidiaries, affiliates, and distributors harmless against all claims, costs, damages, and expenses, and reasonable attorney fees arising out of, directly or indirectly, any claim of personal injury or death associated with such unintended or unauthorized use, even if such claim alleges that ON Semiconductor was negligent regarding the design or manufacture of the part. ON Semiconductor is an Equal Opportunity/Affirmative Action Employer. This literature is subject to all applicable copyright laws and is not for resale in any manner.

# FAN4860

## 3 MHz, Synchronous TinyBoost™ Regulator

### Features

- Operates with Few External Components: 1  $\mu\text{H}$  Inductor and 0402 Case Size Input and Output Capacitors
- Input Voltage Range from 2.3 V to 5.4 V
- Fixed 3.3 V, 5.0 V, or 5.4 V Output Voltage Options
- Maximum Load Current >150 mA at  $V_{\text{IN}}=2.3\text{ V}$
- Maximum Load Current 300 mA at  $V_{\text{IN}}=3.3\text{ V}$ ,  $V_{\text{OUT}}=5.4\text{ V}$
- Maximum Load Current 300 mA at  $V_{\text{IN}}=3.3\text{ V}$ ,  $V_{\text{OUT}}=5.0\text{ V}$
- Maximum Load Current 300 mA at  $V_{\text{IN}}=2.7\text{ V}$ ,  $V_{\text{OUT}}=3.3\text{ V}$
- Up to 92% Efficient
- Low Operating Quiescent Current
- True Load Disconnect During Shutdown
- Variable On-time Pulse Frequency Modulation (PFM) with Light-Load Power-Saving Mode
- Internal Synchronous Rectifier (No External Diode Needed)
- Thermal Shutdown and Overload Protection
- 6-Pin 2 x 2 mm UMLP
- 6-Bump WLCSP, 0.4 mm Pitch

### Applications

- USB “On the Go” 5 V Supply
- 5 V Supply – HDMI, H-Bridge Motor Drivers
- Powering 3.3 V Core Rails
- PDAs, Portable Media Players
- Cell Phones, Smart Phones, Portable Instruments

### Description

The FAN4860 is a low-power boost regulator designed to provide a regulated 3.3 V, 5.0 V or 5.4 V output from a single cell Lithium or Li-Ion battery. Output voltage options are fixed at 3.3 V, 5.0 V, or 5.4 V with a guaranteed maximum load current of 200 mA at  $V_{\text{IN}}=2.3\text{ V}$  and 300 mA at  $V_{\text{IN}}=3.3\text{ V}$ . Input current in Shutdown Mode is less than 1  $\mu\text{A}$ , which maximizes battery life.

Light-load PFM operation is automatic and “glitch-free”. The regulator maintains output regulation at no-load with as low as 37  $\mu\text{A}$  quiescent current.

The combination of built-in power transistors, synchronous rectification, and low supply current make the FAN4860 ideal for battery powered applications.

The FAN4860 is available in 6-bump 0.4 mm pitch Wafer-Level Chip Scale Package (WLCSP) and a 6-lead 2x2 mm ultra-thin MLP package.

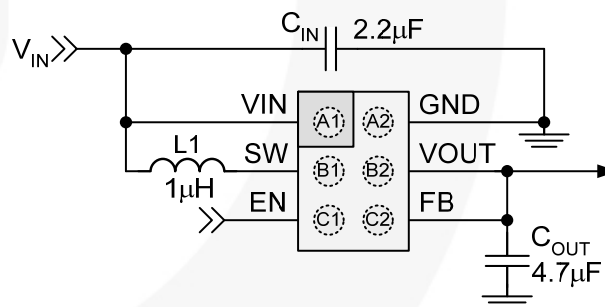


Figure 1. Typical Application

### Ordering Information

Part Number	Operating Temperature Range	Package	Packing Method
FAN4860UC5X	-40°C to 85°C	WLCSP, 0.4 mm Pitch	Tape and Reel
FAN4860UMP5X	-40°C to 85°C	UMLP-6, 2 x 2 mm	Tape and Reel
FAN4860UC33X	-40°C to 85°C	WLCSP, 0.4 mm Pitch	Tape and Reel
FAN4860UC54X	-40°C to 85°C	WLCSP, 0.4 mm Pitch	Tape and Reel

## Block Diagrams

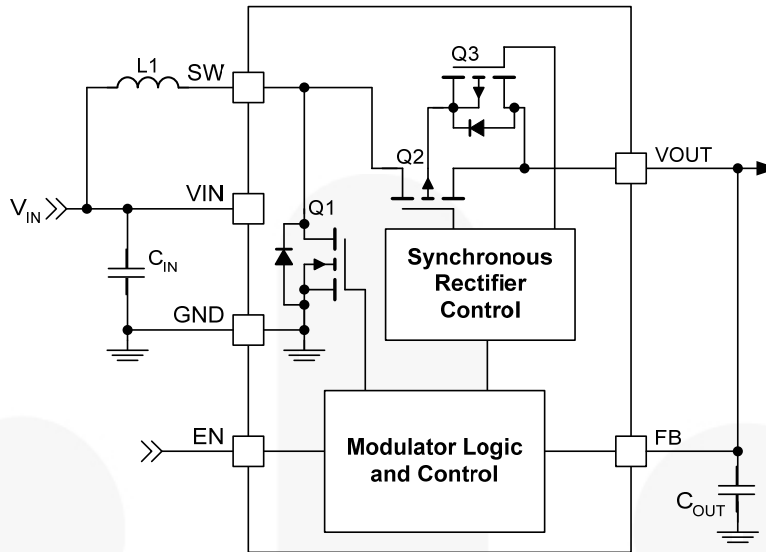


Figure 2. IC Block Diagram

## Pin Configurations

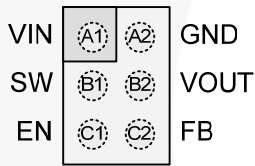


Figure 3. WLCSP (Top View)

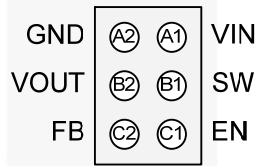


Figure 4. WLCSP (Bottom View)

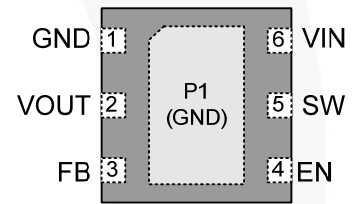


Figure 5. 2x2 mm UMLP (Top View)

## Pin Definitions

Pin #		Name	Description
WLCSP	UMLP		
A1	6	VIN	<b>Input Voltage.</b> Connect to Li-Ion battery input power source and input capacitor ( $C_{IN}$ ).
B1	5	SW	<b>Switching Node.</b> Connect to inductor.
C1	4	EN	<b>Enable.</b> When this pin is HIGH, the circuit is enabled. This pin should not be left floating.
C2	3	FB	<b>Feedback.</b> Output voltage sense point for $V_{OUT}$ . Connect to output capacitor ( $C_{OUT}$ ).
B2	2	VOUT	<b>Output Voltage.</b> This pin is both the output voltage terminal as well as an IC bias supply.
A2	1, P1	GND	<b>Ground.</b> Power and signal ground reference for the IC. All voltages are measured with respect to this pin.

## Absolute Maximum Ratings

Stresses exceeding the absolute maximum ratings may damage the device. The device may not function or be operable above the recommended operating conditions and stressing the parts to these levels is not recommended. In addition, extended exposure to stresses above the recommended operating conditions may affect device reliability. The absolute maximum ratings are stress ratings only.

Symbol	Parameter		Min.	Max.	Units
V <sub>IN</sub>	VIN Pin		-0.3	5.5	V
V <sub>OUT</sub>	VOUT Pin		-2	6	V
V <sub>FB</sub>	FB Pin		-2	6	V
V <sub>SW</sub>	SW Node	DC	-0.3	5.5	V
		Transient: 10 ns, 3 MHz	-1.0	6.5	
V <sub>EN</sub>	EN Pin		-0.3	5.5	V
ESD	Electrostatic Discharge Protection Level	Human Body Model per JESD22-A114	2		kV
		Charged Device Model per JESD22-C101	1		
T <sub>J</sub>	Junction Temperature		-40	+150	°C
T <sub>STG</sub>	Storage Temperature		-65	+150	°C
T <sub>L</sub>	Lead Soldering Temperature, 10 Seconds			+260	°C

## Recommended Operating Conditions

The Recommended Operating Conditions table defines the conditions for actual device operation. Recommended operating conditions are specified to ensure optimal performance to the datasheet specifications. Fairchild does not recommend exceeding them or designing to absolute maximum ratings.

Symbol	Parameter		Min.	Max.	Units
V <sub>IN</sub>	Supply Voltage	5.4 V <sub>OUT</sub>	2.3	4.5	V
		5.0 V <sub>OUT</sub>	2.3	4.5	
		3.3 V <sub>OUT</sub>	2.3	3.2	
I <sub>OUT</sub>	Output Current			200	mA
T <sub>A</sub>	Ambient Temperature		-40	+85	°C
T <sub>J</sub>	Junction Temperature		-40	+125	°C

## Thermal Properties

Junction-to-ambient thermal resistance is a function of application and board layout. This data is measured with four-layer 2s2p boards in accordance to JEDEC standard JESD51. Special attention must be paid not to exceed junction temperature T<sub>J(max)</sub> at a given ambient temperature T<sub>A</sub>.

Symbol	Parameter		Typical	Units
θ <sub>JA</sub>	Junction-to-Ambient Thermal Resistance	WLCSP	130	°C/W
		UMLP	57	°C/W

## Electrical Specifications

Minimum and maximum values are at  $V_{IN}=V_{EN}=2.3\text{ V}$  to  $4.5\text{ V}$  ( $2.5$  to  $3.2\text{ V}_{IN}$  for  $3.3\text{ V}_{OUT}$  option),  $T_A=-40^\circ\text{C}$  to  $+85^\circ\text{C}$ ; circuit of Figure 1, unless otherwise noted. Typical values are at  $T_A=25^\circ\text{C}$ ,  $V_{IN}=V_{EN}=3.6\text{ V}$  for  $V_{OUT}=5.0\text{ V} / 5.4\text{ V}$ , and  $V_{IN}=V_{EN}=2.7\text{ V}$  for  $V_{OUT}=3.3\text{ V}$ .

Symbol	Parameter	Conditions	Min.	Typ.	Max.	Units	
$I_{IN}$	$V_{IN}$ Input Current	$5.4\text{ V}_{OUT}$	Quiescent: $V_{IN}=3.6\text{ V}$ , $I_{OUT}=0$ , $EN=V_{IN}$		37	45	$\mu\text{A}$
			Shutdown: $EN=0$ , $V_{IN}=3.6\text{ V}$		0.5	1.5	
		$5.0\text{ V}_{OUT}$	Quiescent: $V_{IN}=3.6\text{ V}$ , $I_{OUT}=0$ , $EN=V_{IN}$		37	45	
			Shutdown: $EN=0$ , $V_{IN}=3.6\text{ V}$		0.5	1.5	
		$3.3\text{ V}_{OUT}$	Quiescent: $V_{IN}=2.7\text{ V}$ , $I_{OUT}=0$ , $EN=V_{IN}$		50	65	
			Shutdown: $EN=0$ , $V_{IN}=2.7\text{ V}$		0.5	1.5	
$I_{LK\_OUT}$	$V_{OUT}$ Leakage Current	$V_{OUT}=0$ , $EN=0$ , $V_{IN}\geq 3\text{ V}$		10		nA	
$I_{LK\_RVS}$	$V_{OUT}$ to $V_{IN}$ Reverse Leakage	$V_{OUT}=5.4\text{ V}$ , $V_{IN}=3.6\text{ V}$ , $EN=0$			2.5	$\mu\text{A}$	
		$V_{OUT}=5.0\text{ V}$ , $V_{IN}=3.6\text{ V}$ , $EN=0$					
		$V_{OUT}=3.3\text{ V}$ , $V_{IN}=3.0\text{ V}$ , $EN=0$					
$V_{UVLO}$	Under-Voltage Lockout	$V_{IN}$ Rising		2.2	2.3	V	
$V_{UVLO\_HYS}$	Under-Voltage Lockout Hysteresis			190		mV	
$V_{ENH}$	Enable HIGH Voltage		1.05			V	
$V_{ENL}$	Enable LOW Voltage				0.4	V	
$I_{LK\_EN}$	Enable Input Leakage Current			0.01	1.00	$\mu\text{A}$	
$V_{OUT}$	Output Voltage Accuracy <sup>(1)</sup>	$5.4\text{ V}_{OUT}$	$V_{IN}$ from $2.3\text{ V}$ to $4.5\text{ V}$ , $I_{OUT}\leq 200\text{ mA}$	5.15	5.40	5.50	V
			$V_{IN}$ from $2.7\text{ V}$ to $4.5\text{ V}$ , $I_{OUT}\leq 200\text{ mA}$	5.20	5.40	5.50	
			$V_{IN}$ from $3.3\text{ V}$ to $4.5\text{ V}$ , $I_{OUT}\leq 300\text{ mA}$	5.15	5.40	5.50	
		$5.0\text{ V}_{OUT}$	$V_{IN}$ from $2.3\text{ V}$ to $4.5\text{ V}$ , $I_{OUT}\leq 200\text{ mA}$	4.80	5.05	5.15	
			$V_{IN}$ from $2.7\text{ V}$ to $4.5\text{ V}$ , $I_{OUT}\leq 200\text{ mA}$	4.85	5.05	5.15	
			$V_{IN}$ from $3.3\text{ V}$ to $4.5\text{ V}$ , $I_{OUT}\leq 300\text{ mA}$	4.85	5.05	5.15	
		$3.3\text{ V}_{OUT}$	$V_{IN}$ from $2.5\text{ V}$ to $3.2\text{ V}$ , $I_{OUT}\leq 200\text{ mA}$	3.17	3.33	3.41	
$V_{REF}$	Reference Accuracy	Referred to $V_{OUT}=5.4\text{ V}$	5.325	5.400	5.475	V	
		Referred to $V_{OUT}=5.0\text{ V}$	4.975	5.050	5.125		
		Referred to $V_{OUT}=3.3\text{ V}$	3.280	3.330	3.380		
$t_{OFF}$	Off Time	$V_{IN}=3.6\text{ V}$ , $V_{OUT}=5.4\text{ V}$ , $I_{OUT}=200\text{ mA}$	185	230	255	ns	
		$V_{IN}=3.6\text{ V}$ , $V_{OUT}=5.0\text{ V}$ , $I_{OUT}=200\text{ mA}$	195	240	265		
		$V_{IN}=2.7\text{ V}$ , $V_{OUT}=3.3\text{ V}$ , $I_{OUT}=200\text{ mA}$	240	290	350		
$I_{OUT}$	Maximum Output Current <sup>(1)</sup>	$5.4\text{ V}_{OUT}$	$V_{IN}=2.3\text{ V}$	200			mA
			$V_{IN}=3.3\text{ V}$	300			
			$V_{IN}=3.6\text{ V}$		400		
		$5.0\text{ V}_{OUT}$	$V_{IN}=2.3\text{ V}$	200			
			$V_{IN}=3.3\text{ V}$	300			
			$V_{IN}=3.6\text{ V}$		400		
		$3.3\text{ V}_{OUT}$	$V_{IN}=2.5\text{ V}$	250			
			$V_{IN}=2.7\text{ V}$	300			
		$I_{SW}$	SW Peak Current Limit	$5.4\text{ V}_{OUT}$	$V_{IN}=3.6\text{ V}$ , $V_{OUT}>V_{IN}$	1000	
$5.0\text{ V}_{OUT}$	$V_{IN}=3.6\text{ V}$ , $V_{OUT}>V_{IN}$			930	1100	1320	
$3.3\text{ V}_{OUT}$	$V_{IN}=2.7\text{ V}$ , $V_{OUT}>V_{IN}$			650	800	950	

Continued on the following page...

## Electrical Specifications

Minimum and maximum values are at  $V_{IN}=V_{EN}=2.3\text{ V}$  to  $4.5\text{ V}$  ( $2.5$  to  $3.2\text{ V}_{IN}$  for  $3.3\text{ V}_{OUT}$  option),  $T_A=-40^\circ\text{C}$  to  $+85^\circ\text{C}$ ; circuit of Figure 1, unless otherwise noted. Typical values are at  $T_A=25^\circ\text{C}$ ,  $V_{IN}=V_{EN}=3.6\text{ V}$  for  $V_{OUT}=5.0\text{ V} / 5.4\text{ V}$ , and  $V_{IN}=V_{EN}=2.7\text{ V}$  for  $V_{OUT}=3.3\text{ V}$ .

Symbol	Parameter	Conditions	Min.	Typ.	Max.	Units	
$I_{SS}$	Soft-Start Input Peak Current Limit <sup>(2)</sup>	$5.4\text{ V}_{OUT}$	$V_{IN}=3.6\text{ V}$ , $V_{OUT} < V_{IN}$		900	mA	
		$5.0\text{ V}_{OUT}$	$V_{IN}=3.6\text{ V}$ , $V_{OUT} < V_{IN}$		850		
		$3.3\text{ V}_{OUT}$	$V_{IN}=2.7\text{ V}$ , $V_{OUT} < V_{IN}$		700		
$t_{SS}$	Soft-Start Time <sup>(3)</sup>	$5.4\text{ V}_{OUT}$	$V_{IN}=3.6\text{ V}$ , $I_{OUT}=200\text{ mA}$		270	400	$\mu\text{s}$
		$5.0\text{ V}_{OUT}$	$V_{IN}=3.6\text{ V}$ , $I_{OUT}=200\text{ mA}$		100	300	
		$3.3\text{ V}_{OUT}$	$V_{IN}=2.7\text{ V}$ , $I_{OUT}=200\text{ mA}$		250	750	
$R_{DS(ON)}$	N-Channel Boost Switch	$V_{IN}=3.6\text{ V}$		300		m $\Omega$	
	P-Channel Sync Rectifier	$V_{IN}=3.6\text{ V}$		400			
$T_{TSD}$	Thermal Shutdown	$I_{LOAD}=10\text{ mA}$		150		$^\circ\text{C}$	
$T_{TSD\_HYS}$	Thermal Shutdown Hysteresis			30		$^\circ\text{C}$	

### Notes:

- $I_{LOAD}$  from 0 to  $I_{OUT}$ ; also includes load transient response.  $V_{OUT}$  measured from mid-point of output voltage ripple. Effective capacitance of  $C_{OUT} > 1.5\text{ }\mu\text{F}$ .
- Guaranteed by design and characterization; not tested in production.
- Elapsed time from rising EN until regulated  $V_{OUT}$ .

## 5.4 V<sub>OUT</sub> Typical Characteristics

Unless otherwise specified; circuit per Figure 1, 3.6 V<sub>IN</sub>, and T<sub>A</sub>=25°C.

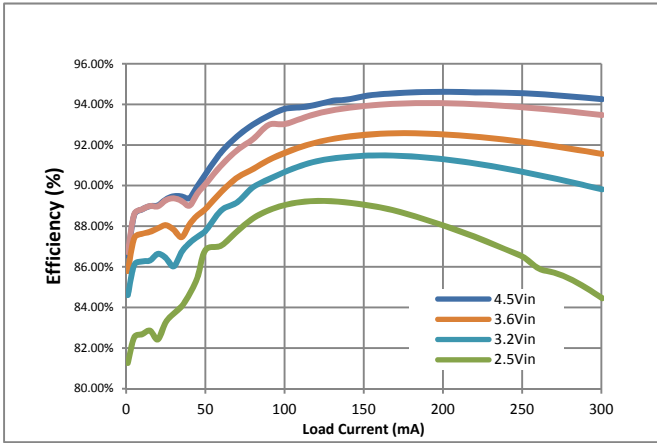


Figure 6. Efficiency vs. V<sub>IN</sub>

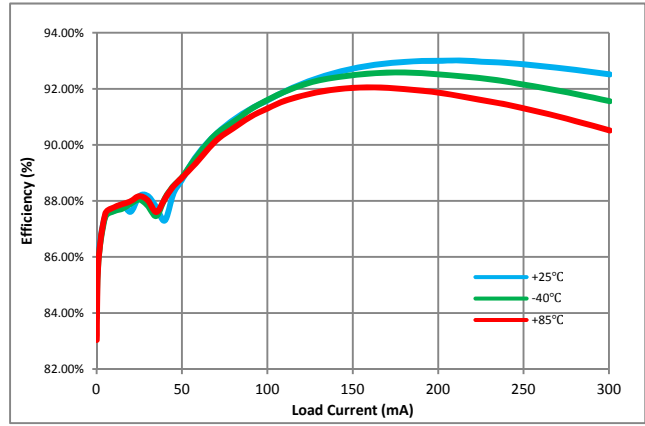


Figure 7. Efficiency vs. Temperature, 3.6 V<sub>IN</sub>

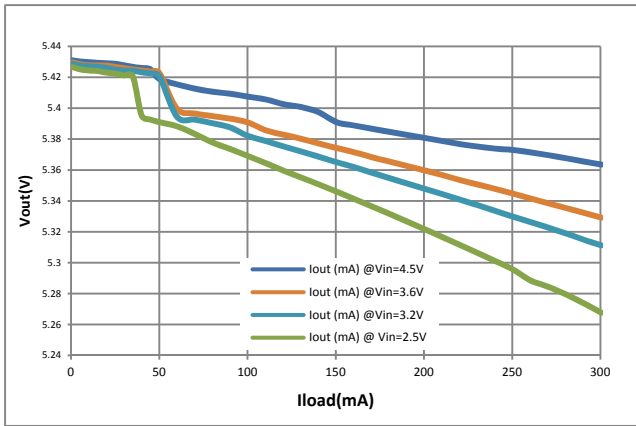


Figure 8. Line and Load Regulation

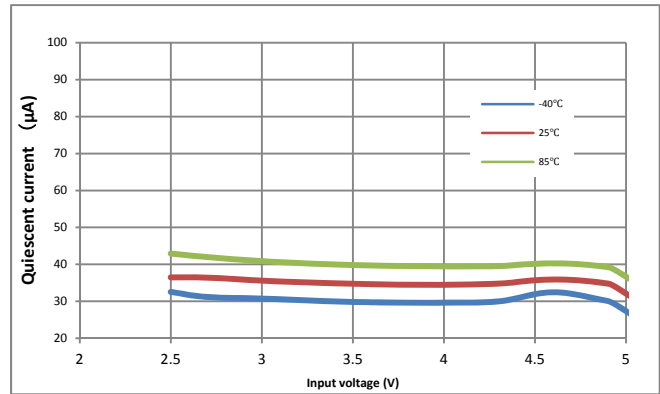


Figure 9. Quiescent Current

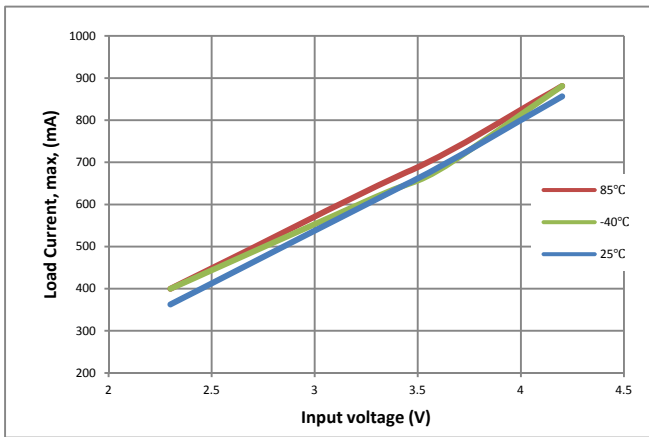


Figure 10. Maximum DC Load Current

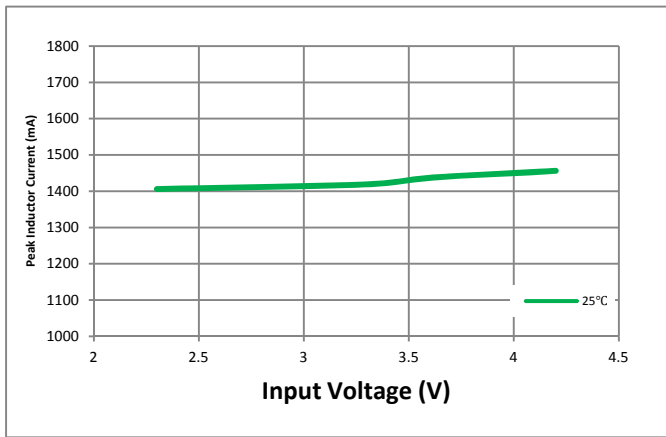


Figure 11. Peak Inductor Current

### 5.4 V<sub>OUT</sub> Typical Characteristics

Unless otherwise specified; circuit per Figure 1, 3.6 V<sub>IN</sub>, and T<sub>A</sub>=25°C.

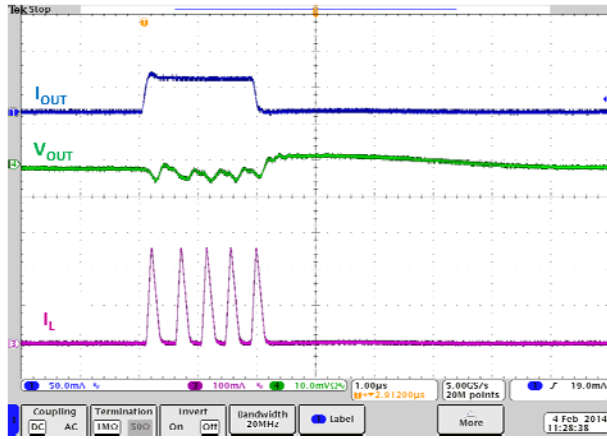


Figure 12. 0-50 mA Load Transient, 100 ns Step

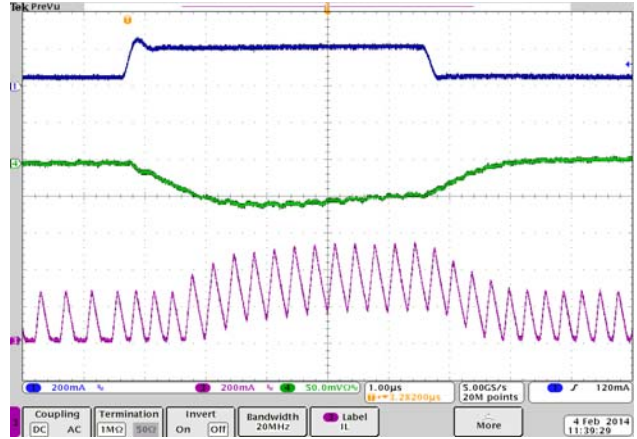


Figure 13. 50-200 mA Load Transient, 100 ns Step

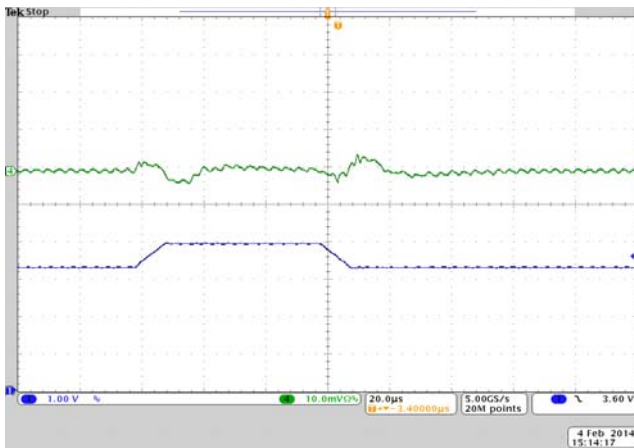


Figure 14. Line Transient, 5 mA Load, 10 μs Step

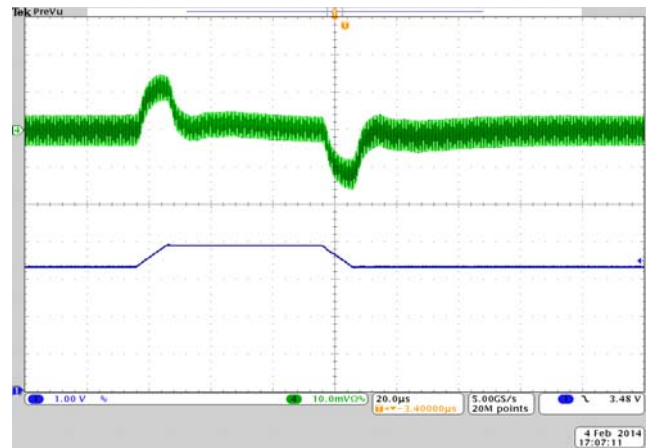


Figure 15. Line Transient, 200 mA Load, 10 μs Step

### 5.0 V<sub>OUT</sub> Typical Characteristics

Unless otherwise specified; circuit per Figure 1, 3.6 V<sub>IN</sub>, and T<sub>A</sub>=25°C.

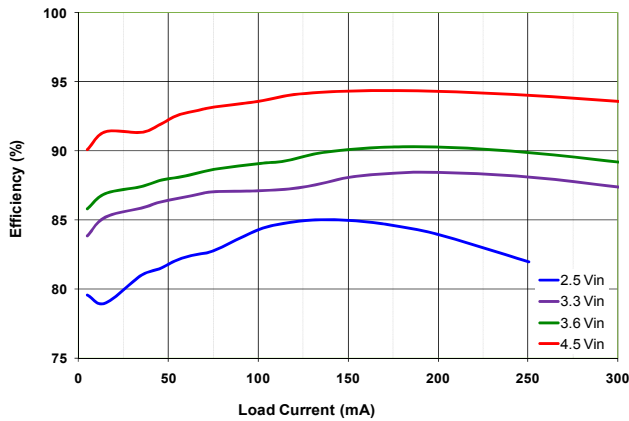


Figure 16. Efficiency vs. V<sub>IN</sub>

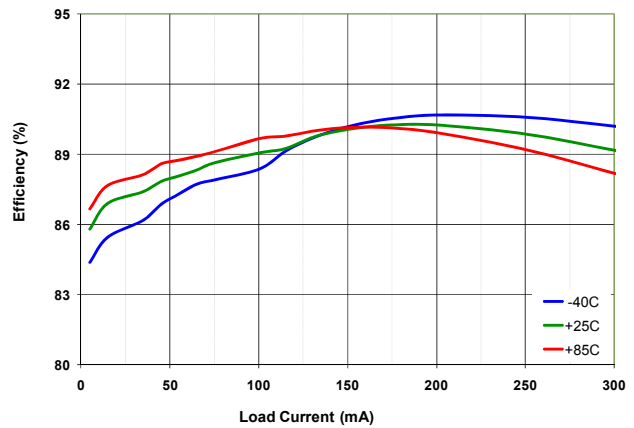


Figure 17. Efficiency vs. Temperature, 3.6 V<sub>IN</sub>



## 5.0 V<sub>OUT</sub> Typical Characteristics

Unless otherwise specified; circuit per Figure 1, 3.6 V<sub>IN</sub>, and T<sub>A</sub>=25°C.

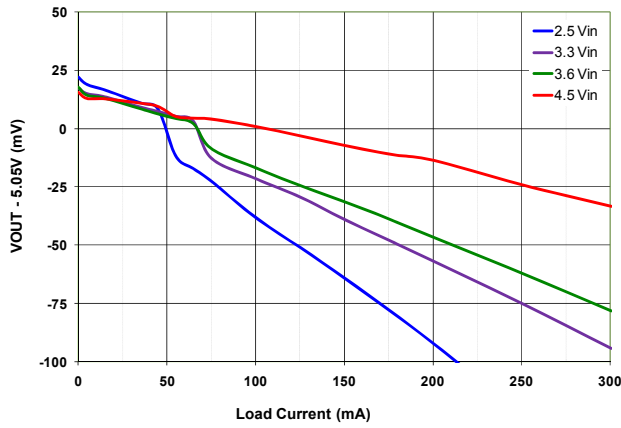


Figure 18. Line and Load Regulation

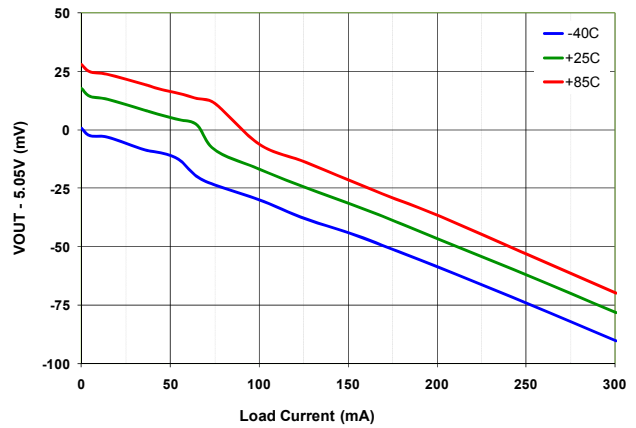


Figure 19. Load Regulation vs. Temperature, 3.6 V<sub>IN</sub>

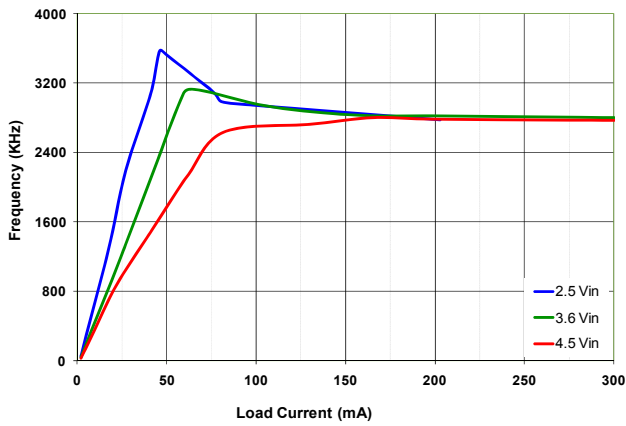


Figure 20. Switching Frequency

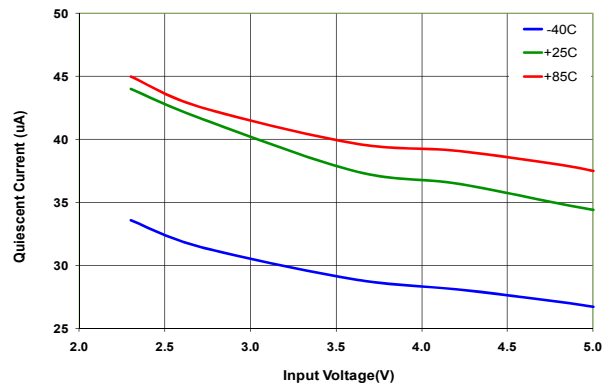


Figure 21. Quiescent Current

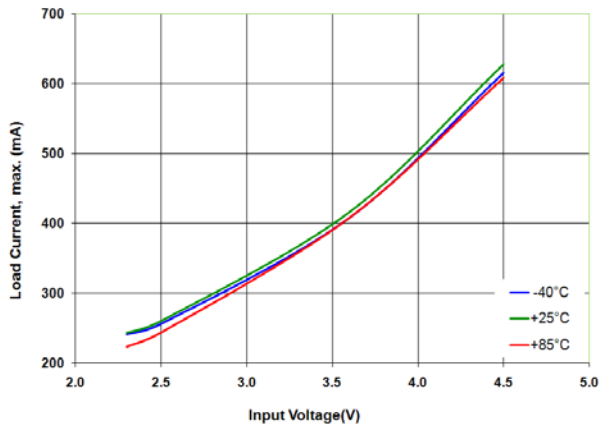


Figure 22. Maximum DC Load Current

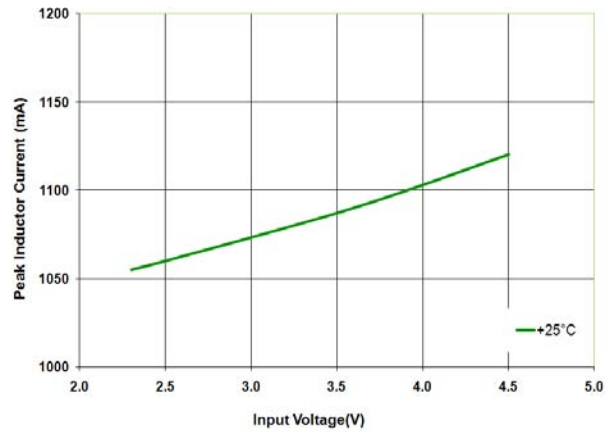


Figure 23. Peak Inductor Current

### 5.0 V<sub>OUT</sub> Typical Characteristics

Unless otherwise specified; circuit per Figure 1, 3.6 V<sub>IN</sub>, and T<sub>A</sub>=25°C.

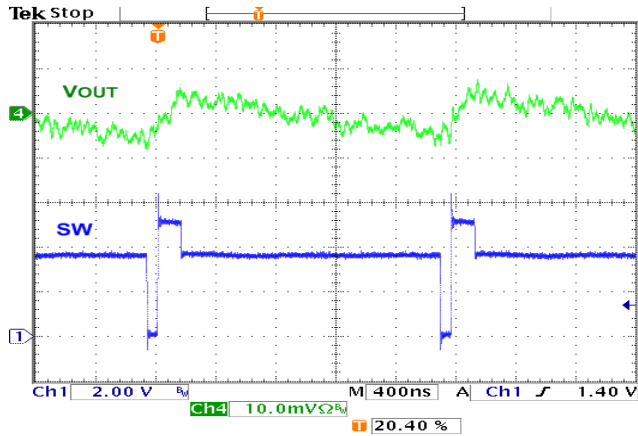


Figure 24. Output Ripple, 10 mA PFM Load

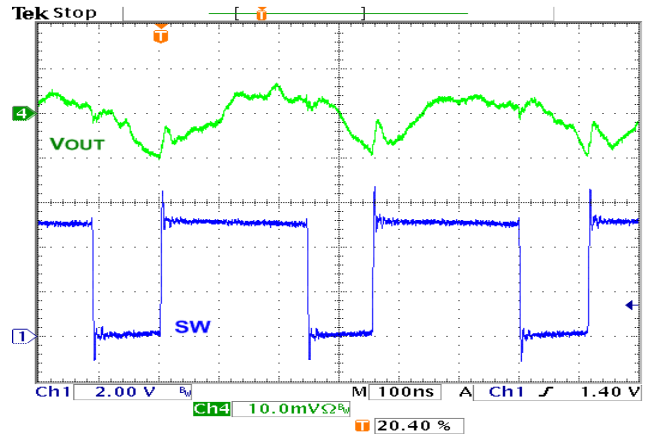


Figure 25. Output Ripple, 200 mA PWM Load

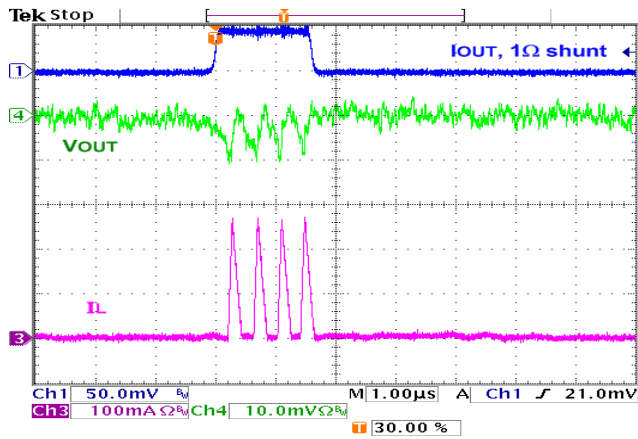


Figure 26. 0-50 mA Load Transient, 100 ns Step

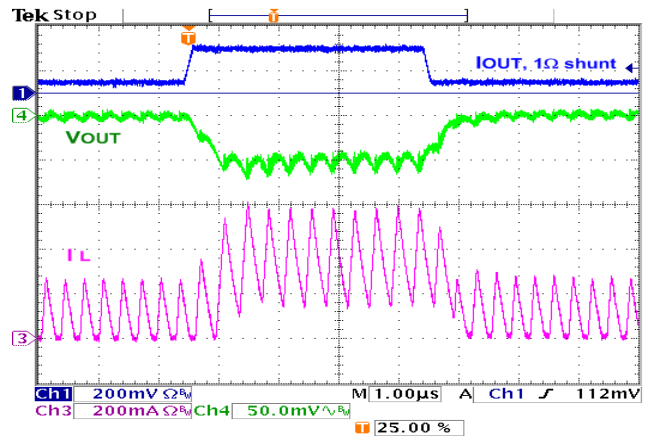


Figure 27. 50-200 mA Load Transient, 100 ns Step

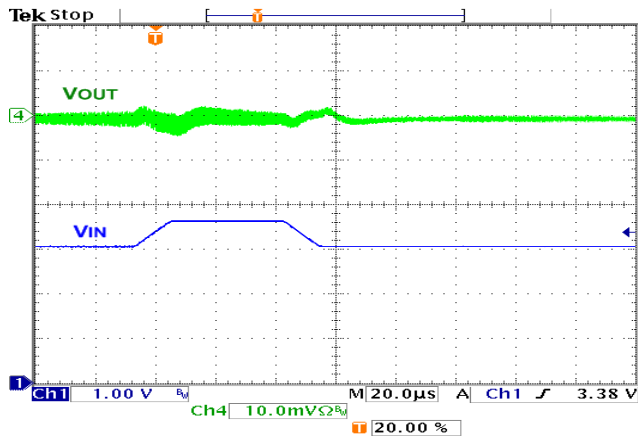


Figure 28. Line Transient, 5 mA Load, 10 μs Step

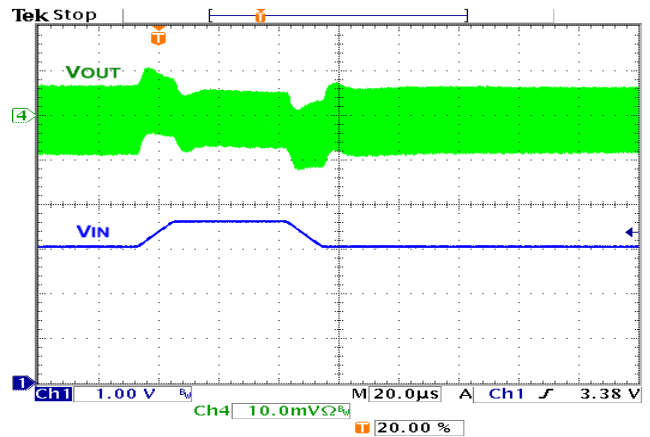


Figure 29. Line Transient, 200 mA Load, 10 μs Step

## 5.0 V<sub>OUT</sub> Typical Characteristics

Unless otherwise specified; circuit per Figure 1, 3.6 V<sub>IN</sub>, and T<sub>A</sub>=25°C.

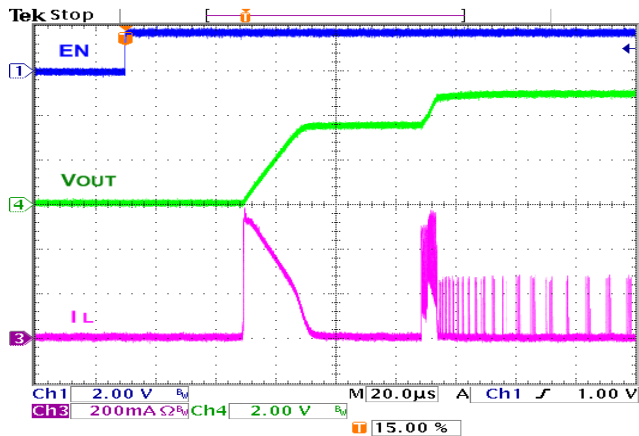


Figure 30. Startup, No Load

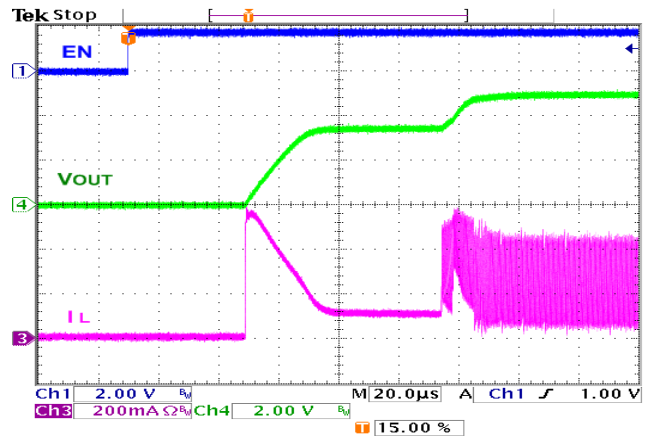


Figure 31. Startup, 33Ω Load

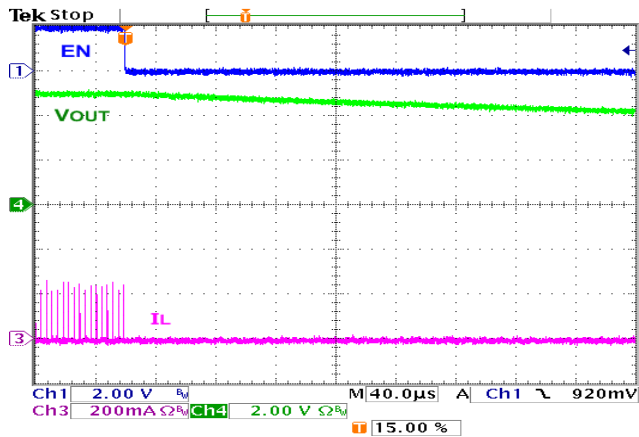


Figure 32. Shutdown, 1kΩ Load

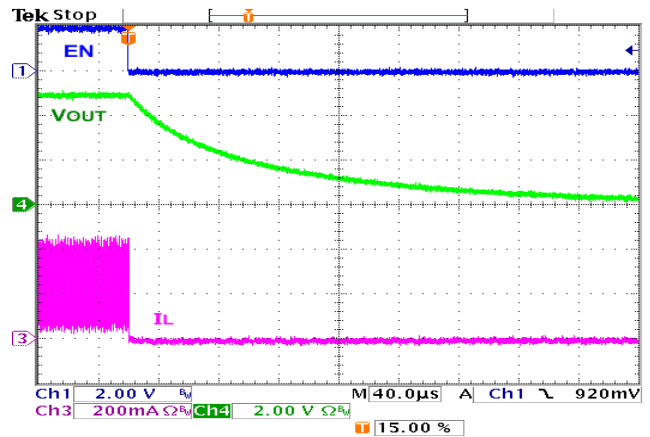


Figure 33. Shutdown, 33Ω Load

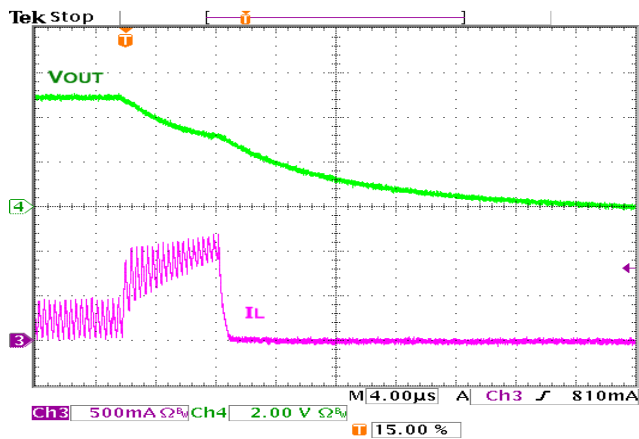


Figure 34. Overload Protection

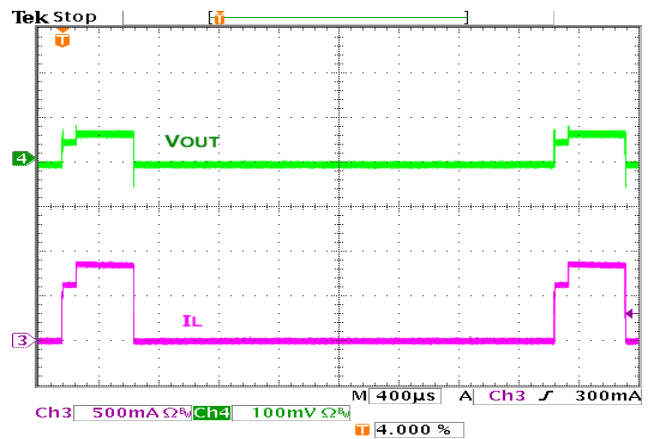


Figure 35. Short-Circuit Response

### 3.3 V<sub>OUT</sub> Typical Characteristics

Unless otherwise specified; circuit per Figure 1, 3.0 V<sub>IN</sub>, and T<sub>A</sub>=25°C.

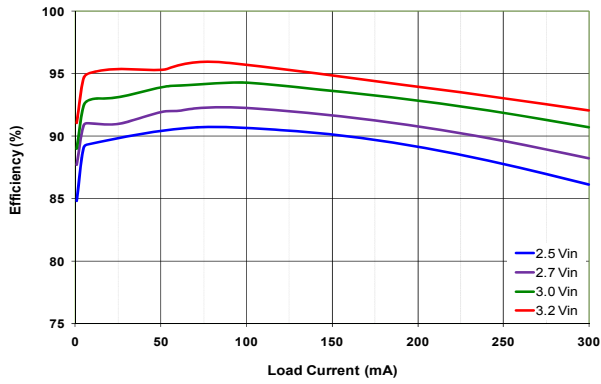


Figure 36. Efficiency vs. V<sub>IN</sub>

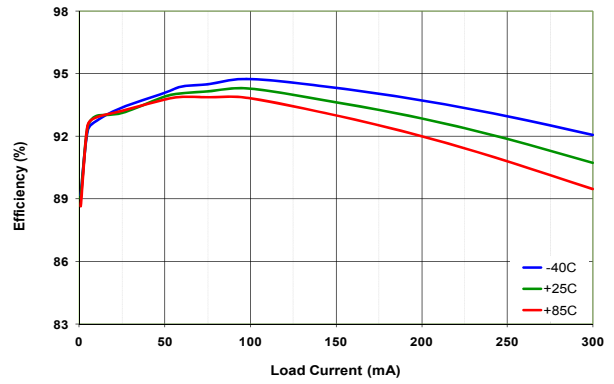


Figure 37. Efficiency vs. Temperature, 3.0 V<sub>IN</sub>

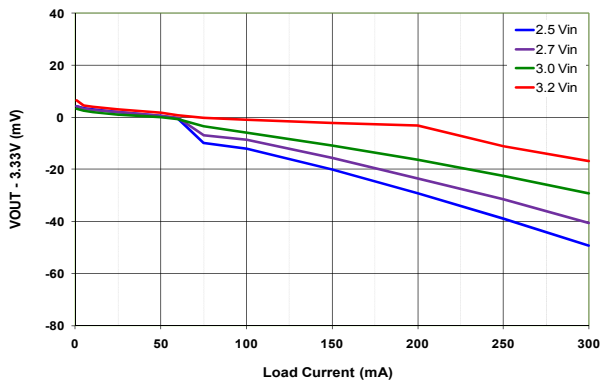


Figure 38. Line and Load Regulation

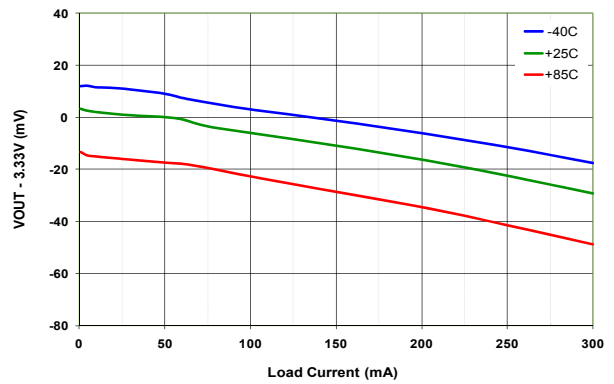


Figure 39. Load Regulation vs. Temperature, 3.0 V<sub>IN</sub>

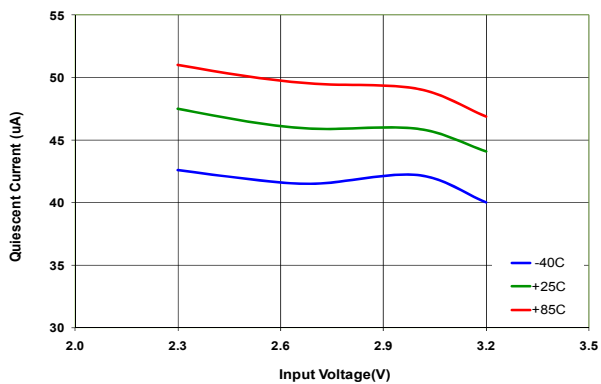


Figure 40. Quiescent Current

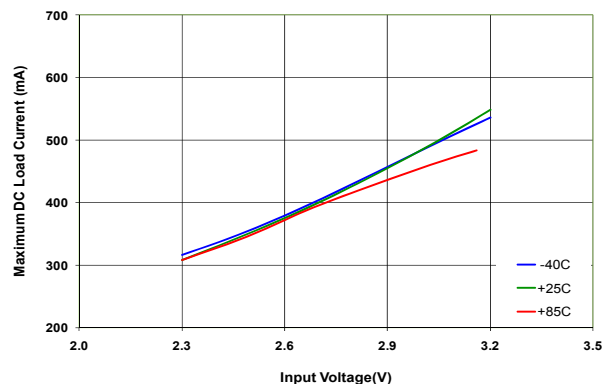


Figure 41. Maximum DC Load Current

### 3.3 V<sub>OUT</sub> Typical Characteristics

Unless otherwise specified; circuit per Figure 1, 3.0 V<sub>IN</sub>, and T<sub>A</sub>=25°C.

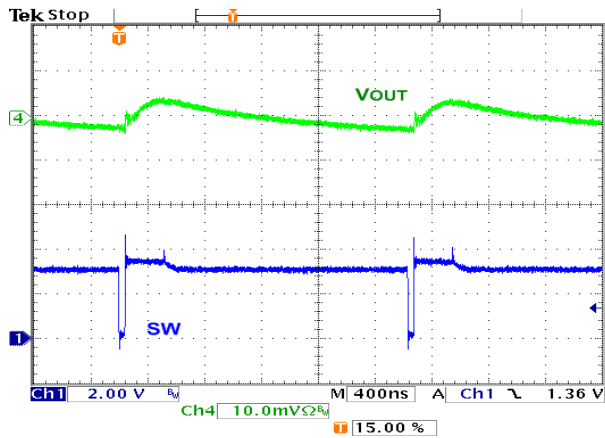


Figure 42. Output Ripple, 10 mA PFM Load

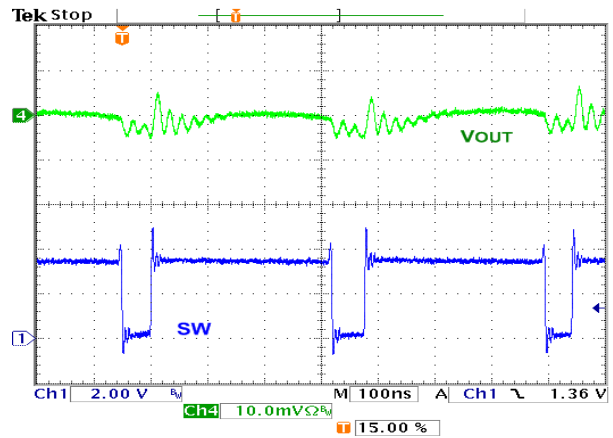


Figure 43. Output Ripple, 200 mA PWM Load

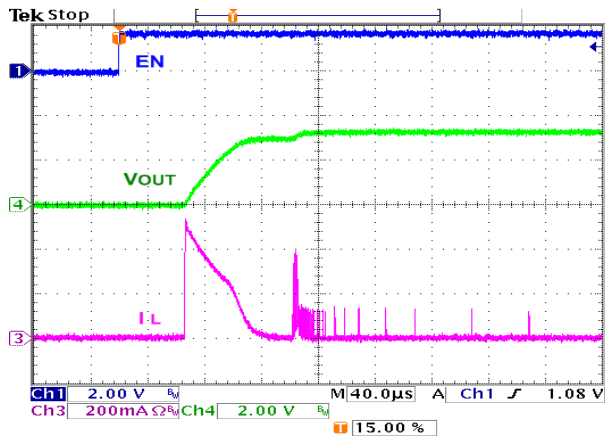


Figure 44. Startup, No Load

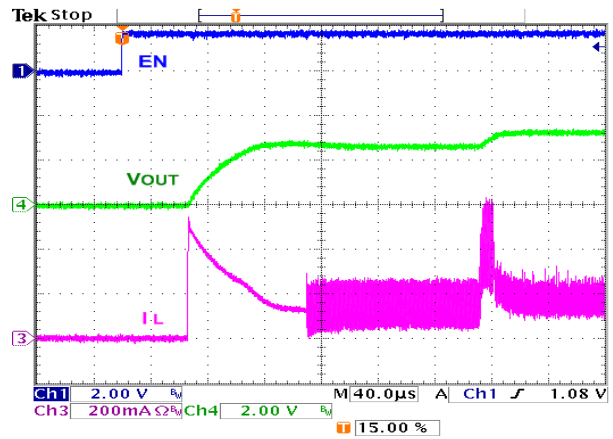


Figure 45. Startup, 22 Ω Load

## Functional Description

### Circuit Description

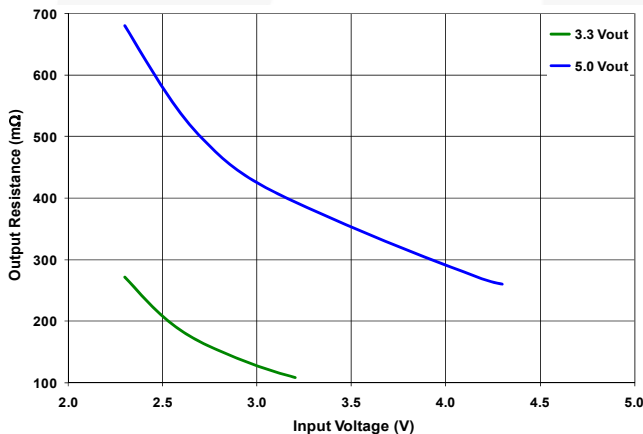
The FAN4860 is a synchronous boost regulator, typically operating at 3 MHz in Continuous Conduction Mode (CCM), which occurs at moderate to heavy load current and low  $V_{IN}$  voltages.

At light-load currents, the converter switches automatically to power-saving PFM Mode. The regulator automatically and smoothly transitions between quasi-fixed-frequency continuous conduction PWM Mode and variable-frequency PFM Mode to maintain the highest possible efficiency over the full range of load current and input voltage.

### PWM Mode Regulation

The FAN4860 uses a minimum on-time and computed minimum off-time to regulate  $V_{OUT}$ . The regulator achieves excellent transient response by employing current mode modulation. This technique causes the regulator output to exhibit a load line. During PWM Mode, the output voltage drops slightly as the input current rises. With a constant  $V_{IN}$ , this appears as a constant output resistance.

The “droop” caused by the output resistance when a load is applied allows the regulator to respond smoothly to load transients with negligible overshoot.



**Figure 46. Output Resistance ( $R_{OUT}$ )**

When the regulator is in PWM CCM Mode and the target  $V_{OUT} = 5.05\text{ V}$ ,  $V_{OUT}$  is a function of  $I_{LOAD}$  and can be computed as:

$$V_{OUT} = 5.05 - R_{OUT} \cdot I_{LOAD} \quad (1)$$

For example, at  $V_{IN}=3.3\text{ V}$ , and  $I_{LOAD}=200\text{ mA}$ ,  $V_{OUT}$  drops to:

$$V_{OUT} = 5.05 - 0.38 \cdot 0.2 = 4.974\text{ V} \quad (1A)$$

At  $V_{IN}=2.3\text{ V}$ , and  $I_{LOAD}=200\text{ mA}$ ,  $V_{OUT}$  drops to:

$$V_{OUT} = 5.05 - 0.68 \cdot 0.2 = 4.914\text{ V} \quad (1B)$$

### PFM Mode

If  $V_{OUT} > V_{REF}$  when the minimum off-time has ended, the regulator enters PFM Mode. Boost pulses are inhibited until  $V_{OUT} < V_{REF}$ . The minimum on-time is increased to enable the output to pump up sufficiently with each PFM boost pulse. Therefore, the regulator behaves like a constant on-time regulator, with the bottom of its output voltage ripple at 5.05 V in PFM Mode.

**Table 1. Operating States**

Mode	Description	Invoked When:
LIN	Linear Startup	$V_{IN} > V_{OUT}$
SS	Boost Soft-Start	$V_{OUT} < V_{REG}$
BST	Boost Operating Mode	$V_{OUT}=V_{REG}$

### Shutdown and Startup

If EN is LOW, all bias circuits are off and the regulator is in Shutdown Mode. During shutdown, true load disconnect between battery and load prevents current flow from  $V_{IN}$  to  $V_{OUT}$ , as well as reverse flow from  $V_{OUT}$  to  $V_{IN}$ .

### LIN State

When EN rises, if  $V_{IN} > UVLO$ , the regulator first attempts to bring  $V_{OUT}$  within about 1V of  $V_{IN}$  by using the internal fixed current source from  $V_{IN}$  ( $I_{LIN1}$ ). The current is limited to about 630 mA during LIN1 Mode.

If  $V_{OUT}$  reaches  $V_{IN}-1\text{ V}$  during LIN1 Mode, the SS state is initiated. Otherwise, LIN1 times out after 16 clock counts and the LIN2 Mode is entered.

In LIN2 Mode, the current source is incremented to 850 mA. If  $V_{OUT}$  fails to reach  $V_{IN}-1\text{ V}$  after 64 clock counts, a fault condition is declared.

### SS State

Upon the successful completion of the LIN state ( $V_{OUT} \geq V_{IN}-1\text{ V}$ ), the regulator begins switching with boost pulses current limited to about 50% of nominal level, incrementing to full scale over a period of 32 clock counts.

If the output fails to achieve 90% of its set point within 96 clock counts at full-scale current limit, a fault condition is declared.

### BST State

This is the normal operating mode of the regulator. The regulator uses a minimum  $t_{OFF}$ -minimum  $t_{ON}$  modulation scheme. Minimum  $t_{OFF}$  is proportional to  $\frac{V_{IN}}{V_{OUT}}$ , which keeps the regulator’s switching frequency reasonably constant in CCM.  $t_{ON(MIN)}$  is proportional to  $V_{IN}$  and is higher if the inductor current reaches 0 before  $t_{OFF(MIN)}$  during the prior cycle.

To ensure that  $V_{OUT}$  does not pump significantly above the regulation point, the boost switch remains off as long as  $FB > V_{REF}$ .

### Fault State

The regulator enters the FAULT state under any of the following conditions:

- $V_{OUT}$  fails to achieve the voltage required to advance from LIN state to SS state.
- $V_{OUT}$  fails to achieve the voltage required to advance from SS state to BST state.
- Sustained (32 CLK counts) pulse-by-pulse current limit during the BST state.
- The regulator moves from BST to LIN state due to a short circuit or output overload ( $V_{OUT} < V_{IN} - 1\text{ V}$ ).

Once a fault is triggered, the regulator stops switching and presents a high-impedance path between  $V_{IN}$  and  $V_{OUT}$ . After waiting 480 CLK counts, a restart is attempted.

### Soft-Start and Fault Timing

The soft-start timing for each state, and the fault times, are determined by the fault clock, whose period is inversely proportional to  $V_{IN}$ . This allows the regulator more time to charge larger values of  $C_{OUT}$  when  $V_{IN}$  is lower. With higher  $V_{IN}$ , this also reduces power delivered to  $V_{OUT}$  during each cycle in current limit.

The number of clock counts for each state is illustrated in Figure 47.

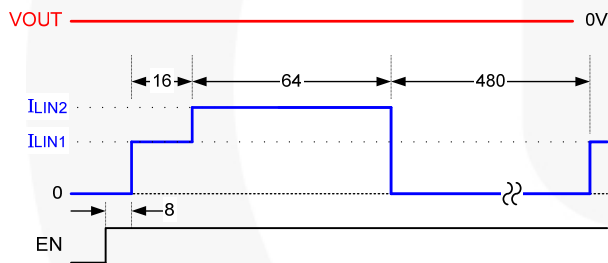


Figure 47. Fault Response into Short Circuit

The fault clock period as a function of  $V_{IN}$  is shown in Figure 48.

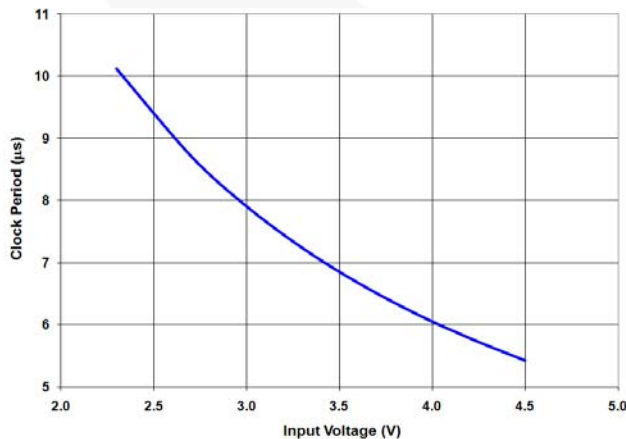


Figure 48. Fault Clock Period vs.  $V_{IN}$

The  $V_{IN}$ -dependent LIN Mode charging current is illustrated in Figure 49.

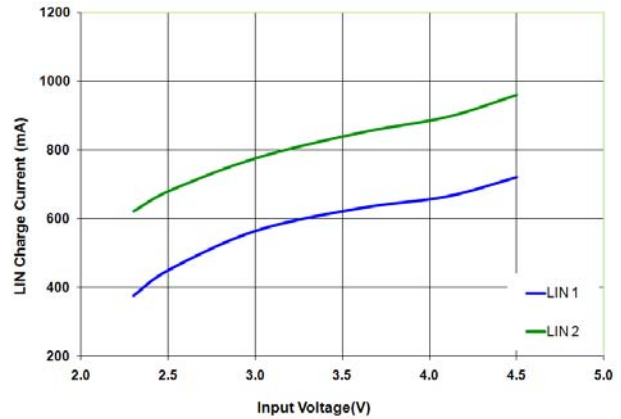


Figure 49. LIN Mode Current vs.  $V_{IN}$

### Over-Temperature Protection (OTP)

The regulator shuts down when the thermal shutdown threshold is reached. Restart, with soft-start, occurs when the IC has cooled by about 30°C.

### Over-Current Protection (OCP)

During Boost Mode, the FAN4860 employs a cycle-by-cycle peak current limit to protect switching elements. Sustained current limit, for 32 consecutive fault clock counts, initiates a fault condition.

During an overload condition, as  $V_{OUT}$  collapses to approximately  $V_{IN} - 1\text{ V}$ , the synchronous rectifier is immediately switched off and a fault condition is declared.

Automatic restart occurs once the overload/short is removed and the fault timer completes counting.



## Application Information

### External Component Selection

Table 2 shows the recommended external components for the FAN4860:

**Table 2. External Components**

REF	Description	Manufacturer
L1	1.0 $\mu$ H, 0.8 A, 190 m $\Omega$ , 0805	Murata LQM21PN1R0MC0, or equivalent
C <sub>IN</sub>	2.2 $\mu$ F, 6.3 V, X5R, 0402	Murata GRM155R60J225M TDK C1005X5R0J225M
C <sub>OUT</sub>	4.7 $\mu$ F, 10 V, X5R, 0603 <sup>(4)</sup>	Kemet C0603C475K8PAC TDK C1608X5R1A475K

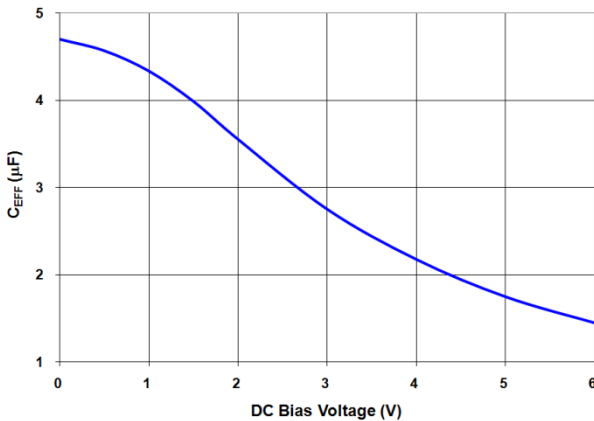
**Note:**

- A 6.3 V-rated 0603 capacitor may be used for C<sub>OUT</sub>, such as Murata GRM188R60J225M. All datasheet parameters are valid with the 6.3 V-rated capacitor. Due to DC bias effects, the 10 V capacitor offers a performance enhancement; particularly output ripple and transient response, without any size increase.

### Output Capacitance (C<sub>OUT</sub>)

#### Stability

The effective capacitance (C<sub>EFF</sub>) of small, high-value, ceramic capacitors decrease as their bias voltage increases, as shown in Figure 50.



**Figure 50. C<sub>EFF</sub> for 4.7  $\mu$ F, 0603, X5R, 6.3 V (Murata GRM188R60J475K)**

FAN4860 is guaranteed for stable operation with the minimum value of C<sub>EFF</sub> (C<sub>EFF(MIN)</sub>) outlined in Table 3.

**Table 3. Minimum C<sub>EFF</sub> Required for Stability**

Operating Conditions		C <sub>EFF(MIN)</sub> (μF)
V <sub>IN</sub> (V)	I <sub>LOAD</sub> (mA)	
2.3 to 4.5	0 to 200	1.5
2.7 to 4.5	0 to 200	1.0
2.3 to 4.5	0 to 150	1.0

C<sub>EFF</sub> varies with manufacturer, dielectric material, case size, and temperature. Some manufacturers may be able to provide an X5R capacitor in 0402 case size that retains C<sub>EFF</sub> >1.5  $\mu$ F with 5V bias; others may not. If this C<sub>EFF</sub> cannot be economically obtained and 0402 case size is required, the IC can work with the 0402 capacitor as long as the minimum V<sub>IN</sub> is restricted to >2.7 V.

For best performance, a 10 V-rated 0603 output capacitor is recommended (Kemet C0603C475K8PAC, or equivalent). Since it retains greater C<sub>EFF</sub> under bias and over temperature, output ripple can be reduced and transient capability enhanced.

### Output Voltage Ripple

Output voltage ripple is inversely proportional to C<sub>OUT</sub>. During t<sub>ON</sub>, when the boost switch is on, all load current is supplied by C<sub>OUT</sub>.

$$V_{\text{RIPPLE(P-P)}} = t_{\text{ON}} \cdot \frac{I_{\text{LOAD}}}{C_{\text{OUT}}} \quad (2)$$

and

$$t_{\text{ON}} = t_{\text{SW}} \cdot D = t_{\text{SW}} \cdot \left(1 - \frac{V_{\text{IN}}}{V_{\text{OUT}}}\right) \quad (3)$$

Therefore:

$$V_{\text{RIPPLE(P-P)}} = t_{\text{SW}} \cdot \left(1 - \frac{V_{\text{IN}}}{V_{\text{OUT}}}\right) \cdot \frac{I_{\text{LOAD}}}{C_{\text{OUT}}} \quad (4)$$

where:

$$t_{\text{SW}} = \frac{1}{f_{\text{SW}}} \quad (5)$$

As can be seen from Equation 4, the maximum V<sub>RI</sub>PPLE occurs when V<sub>IN</sub> is minimum and I<sub>LOAD</sub> is maximum.

### Startup

Input current limiting is in effect during soft-start, which limits the current available to charge C<sub>OUT</sub>. If the output fails to achieve regulation within the time period described in the soft-start section above; a FAULT occurs, causing the circuit to shut down, then restart after a significant time period. If C<sub>OUT</sub> is a very high value, the circuit may not start on the first attempt, but eventually achieves regulation if no load is present. If a high-current load and high capacitance are both present during soft-start, the circuit may fail to achieve regulation and continually attempt soft-start, only to have C<sub>OUT</sub> discharged by the load when in the FAULT state.

The circuit can start with higher values of C<sub>OUT</sub> under full load if V<sub>IN</sub> is higher, since:

$$I_{\text{OUT}} = \left( I_{\text{LIM(PK)}} - \frac{I_{\text{RIPPLE}}}{2} \right) \cdot \frac{V_{\text{IN}}}{V_{\text{OUT}}} \quad (6)$$

Generally, the limitation occurs in BST Mode.



The FAN4860 starts on the first pass (without triggering a FAULT) under the following conditions for  $C_{EFF(MAX)}$ :

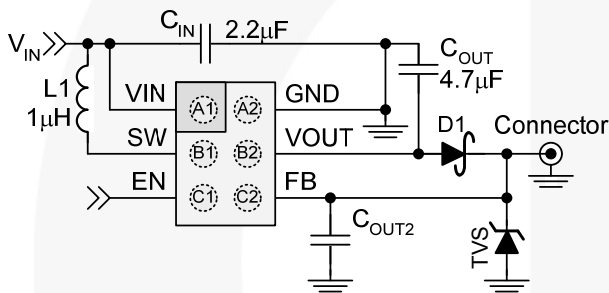
**Table 4. Maximum  $C_{EFF}$  for First-Pass Startup**

Operating Conditions				$C_{EFF(MAX)}$ ( $\mu F$ )
$V_{IN}$ (V)	$R_{LOAD(MIN)}$ ( $\Omega$ )			
	5.4 $V_{OUT}$	5.0 $V_{OUT}$	3.3 $V_{OUT}$	
> 2.3	27	25	16	10
> 2.7	27	25	16	15
> 2.7	37	33	20	22

$C_{EFF}$  values shown in Table 4 typically apply to the lowest  $V_{IN}$ . The presence of higher  $V_{IN}$  enhances ability to start into larger  $C_{EFF}$  at full load.

### Transient Protection

To protect against external voltage transients caused by ESD discharge events, or improper external connections, some applications employ an external transient voltage suppressor (TVS) and Schottky diode (D1 in Figure 51).



**Figure 51. FAN4860 with External Transient Protection**

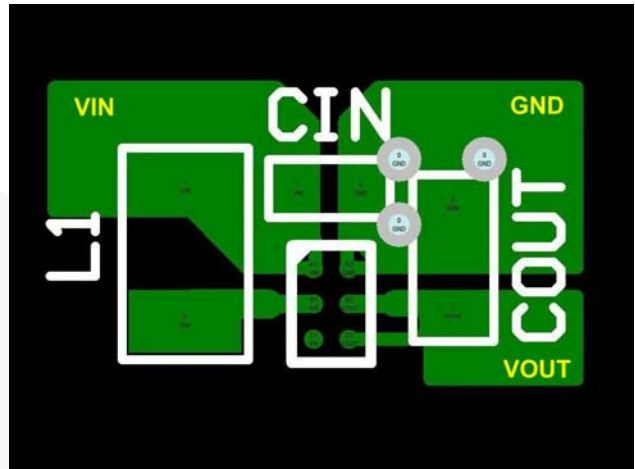
The TVS is designed to clamp the FB line (system  $V_{OUT}$ ) to +10 V or -2 V during external transient events. The Schottky diode protects the output devices from the positive excursion. The FB pin can tolerate up to 14 V of positive excursion, while both the FB and  $V_{OUT}$  pins can tolerate negative voltages.

The FAN4860 includes a circuit to detect a missing or defective D1 by comparing  $V_{OUT}$  to FB. If  $V_{OUT} - FB >$  about 0.7 V, the IC shuts down. The IC remains shut down until  $V_{OUT} < UVLO$  and  $V_{IN} < UVLO + 0.7$  or EN is toggled.

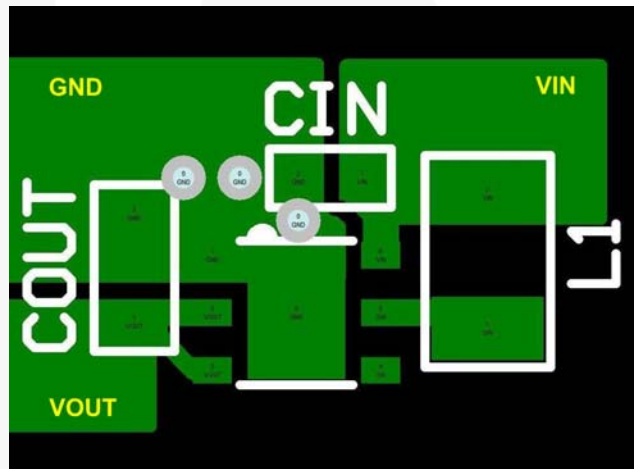
$C_{OUT2}$  may be necessary to preserve load transient response when the Schottky is used. When a load is applied at the FB pin, the forward voltage of the D1 rapidly increases before the regulator can respond or the inductor current can change. This causes an immediate drop of up to 300 mV, depending on D1's characteristics if  $C_{OUT2}$  is absent.  $C_{OUT2}$  supplies instantaneous current to the load while the regulator adjusts the inductor current. A value of at least half of the minimum value of  $C_{OUT}$  should be used for  $C_{OUT2}$ .  $C_{OUT2}$  needs to withstand the maximum voltage at the FB pin as the TVS is clamping.

The maximum DC output current available is reduced with this circuit, due to the additional dissipation of D1.

### Layout Guideline

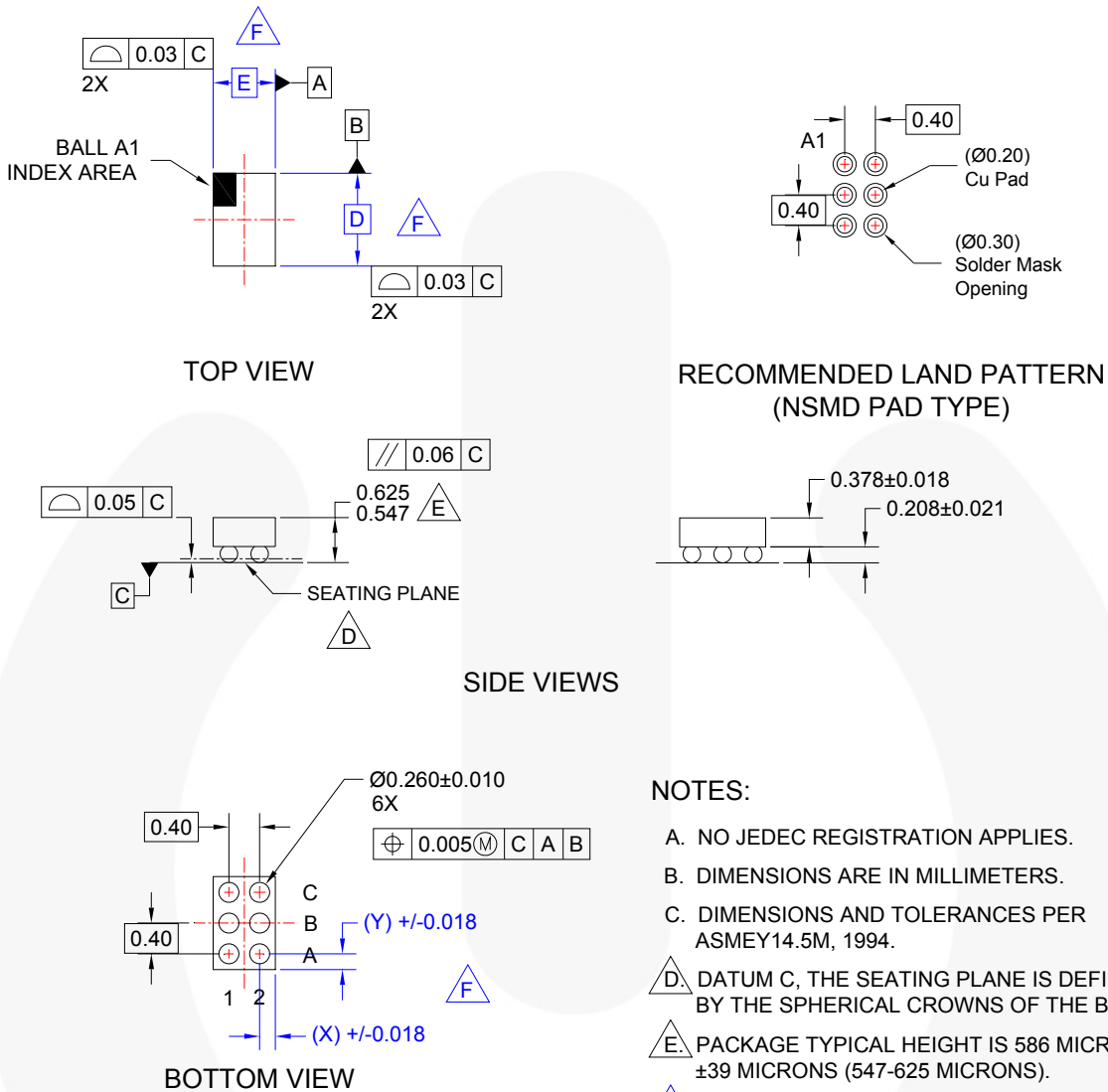


**Figure 52. WLCSP Suggested Layout (Top View)**



**Figure 53. UMLP Suggested Layout (Top View)**

## Physical Dimensions



### NOTES:

- A. NO JEDEC REGISTRATION APPLIES.
- B. DIMENSIONS ARE IN MILLIMETERS.
- C. DIMENSIONS AND TOLERANCES PER ASMEY14.5M, 1994.
- D. DATUM C, THE SEATING PLANE IS DEFINED BY THE SPHERICAL CROWNS OF THE BALLS.
- E. PACKAGE TYPICAL HEIGHT IS 586 MICRONS ±39 MICRONS (547-625 MICRONS).
- F. FOR DIMENSIONS D, E, X, AND Y SEE PRODUCT DATASHEET.
- G. DRAWING FILENAME: UC006ACrev4.

Figure 54. 6-Lead, 0.4 mm Pitch, WLCSP Package

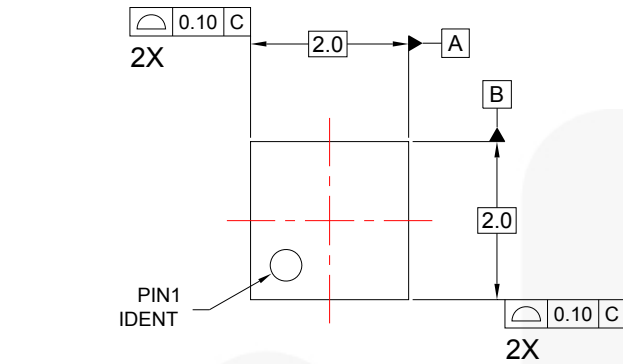
## Product-Specific Dimensions

Product	D	E	X	Y
FAN4860UC5X	1.230mm ±0.030 mm	0.880 mm ±0.030 mm	0.240 mm	0.215 mm
FAN4860UC33X				

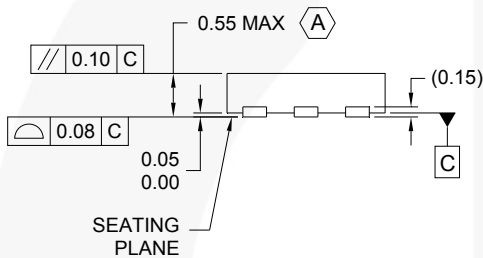
Package drawings are provided as a service to customers considering Fairchild components. Drawings may change in any manner without notice. Please note the revision and/or date on the drawing and contact a Fairchild Semiconductor representative to verify or obtain the most recent revision. Package specifications do not expand the terms of Fairchild's worldwide terms and conditions, specifically the warranty therein, which covers Fairchild products.

Always visit Fairchild Semiconductor's online packaging area for the most recent package drawings:  
<http://www.fairchildsemi.com/dwg/UC/UC006AC.pdf>.

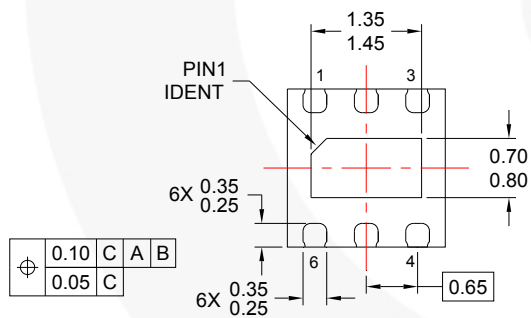
Physical Dimensions



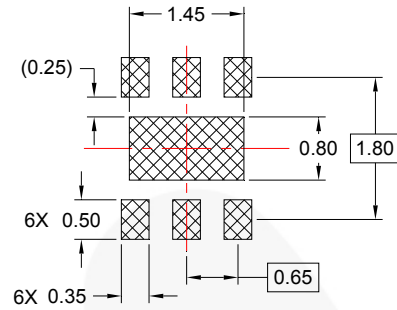
TOP VIEW



SIDE VIEW



BOTTOM VIEW



RECOMMENDED LAND PATTERN

NOTES:

- A. PACKAGE CONFORMS TO JEDEC MO-229 EXCEPT WHERE NOTED.
- B. DIMENSIONS ARE IN MILLIMETERS.
- C. DIMENSIONS AND TOLERANCES PER ASME Y14.5M, 1994.
- D. LANDPATTERN RECOMMENDATION IS BASED ON FSC DESIGN ONLY.
- E. DRAWING FILENAME: MKT-UMLP06Erev2.

Figure 55. 6-Lead, UMLP Package






Package drawings are provided as a service to customers considering Fairchild components. Drawings may change in any manner without notice. Please note the revision and/or date on the drawing and contact a Fairchild Semiconductor representative to verify or obtain the most recent revision. Package specifications do not expand the terms of Fairchild's worldwide terms and conditions, specifically the warranty therein, which covers Fairchild products.

Always visit Fairchild Semiconductor's online packaging area for the most recent package drawings:  
<http://www.fairchildsemi.com/dwg/UM/UMLP06E.pdf>.



**TRADEMARKS**

The following includes registered and unregistered trademarks and service marks, owned by Fairchild Semiconductor and/or its global subsidiaries, and is not intended to be an exhaustive list of all such trademarks.

- |   |  |   |   |
|---|--|---|---|
| AccuPower™  | F-PFS™   |  | Sync-Lock™  |
| AX-CAP®*  | FRFET®   | PowerTrench®  |  SYSTEM GENERAL® |
| BitSiC™   | Global Power Resource™                         | PowerXS™  | TinyBoost®  |
| Build it Now™   | GreenBridge™                                   | Programmable Active Droop™  | TinyBuck®   |
| CorePLUS™   | Green FPS™                                     | QFET®   | TinyCalc™   |
| CorePOWER™  | Green FPS™ e-Series™                           | QS™   | TinyLogic®  |
| CROSSVOLT™  | Gmax™  | Quiet Series™   | TINYOPTO™   |
| CTL™  | GTO™   | RapidConfigure™   | TinyPower™  |
| Current Transfer Logic™   | IntelliMAX™                                    |  | TinyPWM™  |
| DEUXPEED®   | ISOPLANAR™                                     | Saving our world, 1mW/W/kW at a time™   | TinyWire™   |
| Dual Cool™  | Making Small Speakers Sound Louder and Better™ | SignalWise™   | TranSiC™  |
| EcoSPARK®   | MegaBuck™                                      | SmartMax™   | TriFault Detect™  |
| EfficientMax™   | MICROCOUPLER™                                  | SMART START™  | TRUECURRENT®*   |
| ESBC™   | MicroFET™                                      | Solutions for Your Success™   | µSerDes™  |
|  | MicroPak™                                      | SPM®  |                  |
| Fairchild®  | MicroPak2™                                     | STEALTH™  | UHC™  |
| Fairchild Semiconductor®  | MillerDrive™                                   | SuperFET®   | Ultra FRFET™  |
| FACT Quiet Series™  | MotionMax™                                     | SuperSOT™-3   | UniFET™   |
| FACT®   | mWSaver®                                       | SuperSOT™-6   | VCX™  |
| FAST®   | OptoHiT™                                       | SuperSOT™-8   | VisualMax™  |
| FastvCore™  | OPTOLOGIC®                                     | SupreMOS®   | VoltagePlus™  |
| FETBench™   | OPTOPLANAR®                                    | SyncFET™  | XS™   |
| FPS™  |  |   |   |

\* Trademarks of System General Corporation, used under license by Fairchild Semiconductor.

**DISCLAIMER**

FAIRCHILD SEMICONDUCTOR RESERVES THE RIGHT TO MAKE CHANGES WITHOUT FURTHER NOTICE TO ANY PRODUCTS HEREIN TO IMPROVE RELIABILITY, FUNCTION, OR DESIGN. FAIRCHILD DOES NOT ASSUME ANY LIABILITY ARISING OUT OF THE APPLICATION OR USE OF ANY PRODUCT OR CIRCUIT DESCRIBED HEREIN; NEITHER DOES IT CONVEY ANY LICENSE UNDER ITS PATENT RIGHTS, NOR THE RIGHTS OF OTHERS. THESE SPECIFICATIONS DO NOT EXPAND THE TERMS OF FAIRCHILD'S WORLDWIDE TERMS AND CONDITIONS, SPECIFICALLY THE WARRANTY THEREIN, WHICH COVERS THESE PRODUCTS.

**LIFE SUPPORT POLICY**

FAIRCHILD'S PRODUCTS ARE NOT AUTHORIZED FOR USE AS CRITICAL COMPONENTS IN LIFE SUPPORT DEVICES OR SYSTEMS WITHOUT THE EXPRESS WRITTEN APPROVAL OF FAIRCHILD SEMICONDUCTOR CORPORATION.

As used herein:

- Life support devices or systems are devices or systems which, (a) are intended for surgical implant into the body or (b) support or sustain life, and (c) whose failure to perform when properly used in accordance with instructions for use provided in the labeling, can be reasonably expected to result in a significant injury of the user.
- A critical component in any component of a life support device, or system whose failure to perform can be reasonably expected to cause the failure of the life support device or system, or to affect its safety or effectiveness.

**ANTI-COUNTERFEITING POLICY**

Fairchild Semiconductor Corporation's Anti-Counterfeiting Policy. Fairchild's Anti-Counterfeiting Policy is also stated on our external website, [www.fairchildsemi.com](http://www.fairchildsemi.com), under Sales Support.

Counterfeiting of semiconductor parts is a growing problem in the industry. All manufacturers of semiconductor products are experiencing counterfeiting of their parts. Customers who inadvertently purchase counterfeit parts experience many problems such as loss of brand reputation, substandard performance, failed applications, and increased cost of production and manufacturing delays. Fairchild is taking strong measures to protect ourselves and our customers from the proliferation of counterfeit parts. Fairchild strongly encourages customers to purchase Fairchild parts either directly from Fairchild or from Authorized Fairchild Distributors who are listed by country on our web page cited above. Products customers buy either from Fairchild directly or from Authorized Fairchild Distributors are genuine parts, have full traceability, meet Fairchild's quality standards for handling and storage and provide access to Fairchild's full range of up-to-date technical and product information. Fairchild and our Authorized Distributors will stand behind all warranties and will appropriately address any warranty issues that may arise. Fairchild will not provide any warranty coverage or other assistance for parts bought from Unauthorized Sources. Fairchild is committed to combat this global problem and encourage our customers to do their part in stopping this practice by buying direct or from authorized distributors.

**PRODUCT STATUS DEFINITIONS**

**Definition of Terms**

Datasheet Identification	Product Status	Definition
Advance Information	Formative / In Design	Datasheet contains the design specifications for product development. Specifications may change in any manner without notice.
Preliminary	First Production	Datasheet contains preliminary data; supplementary data will be published at a later date. Fairchild Semiconductor reserves the right to make changes at any time without notice to improve design.
No Identification Needed	Full Production	Datasheet contains final specifications. Fairchild Semiconductor reserves the right to make changes at any time without notice to improve the design.
Obsolete	Not In Production	Datasheet contains specifications on a product that is discontinued by Fairchild Semiconductor. The datasheet is for reference information only.

Rev. I66

ON Semiconductor and  are trademarks of Semiconductor Components Industries, LLC dba ON Semiconductor or its subsidiaries in the United States and/or other countries. ON Semiconductor owns the rights to a number of patents, trademarks, copyrights, trade secrets, and other intellectual property. A listing of ON Semiconductor's product/patent coverage may be accessed at [www.onsemi.com/site/pdf/Patent-Marking.pdf](http://www.onsemi.com/site/pdf/Patent-Marking.pdf). ON Semiconductor reserves the right to make changes without further notice to any products herein. ON Semiconductor makes no warranty, representation or guarantee regarding the suitability of its products for any particular purpose, nor does ON Semiconductor assume any liability arising out of the application or use of any product or circuit, and specifically disclaims any and all liability, including without limitation special, consequential or incidental damages. Buyer is responsible for its products and applications using ON Semiconductor products, including compliance with all laws, regulations and safety requirements or standards, regardless of any support or applications information provided by ON Semiconductor. "Typical" parameters which may be provided in ON Semiconductor data sheets and/or specifications can and do vary in different applications and actual performance may vary over time. All operating parameters, including "Typicals" must be validated for each customer application by customer's technical experts. ON Semiconductor does not convey any license under its patent rights nor the rights of others. ON Semiconductor products are not designed, intended, or authorized for use as a critical component in life support systems or any FDA Class 3 medical devices or medical devices with a same or similar classification in a foreign jurisdiction or any devices intended for implantation in the human body. Should Buyer purchase or use ON Semiconductor products for any such unintended or unauthorized application, Buyer shall indemnify and hold ON Semiconductor and its officers, employees, subsidiaries, affiliates, and distributors harmless against all claims, costs, damages, and expenses, and reasonable attorney fees arising out of, directly or indirectly, any claim of personal injury or death associated with such unintended or unauthorized use, even if such claim alleges that ON Semiconductor was negligent regarding the design or manufacture of the part. ON Semiconductor is an Equal Opportunity/Affirmative Action Employer. This literature is subject to all applicable copyright laws and is not for resale in any manner.

## PUBLICATION ORDERING INFORMATION

### LITERATURE FULFILLMENT:

Literature Distribution Center for ON Semiconductor  
19521 E. 32nd Pkwy, Aurora, Colorado 80011 USA  
**Phone:** 303-675-2175 or 800-344-3860 Toll Free USA/Canada  
**Fax:** 303-675-2176 or 800-344-3867 Toll Free USA/Canada  
**Email:** [orderlit@onsemi.com](mailto:orderlit@onsemi.com)

**N. American Technical Support:** 800-282-9855 Toll Free  
USA/Canada  
**Europe, Middle East and Africa Technical Support:**  
Phone: 421 33 790 2910  
**Japan Customer Focus Center**  
Phone: 81-3-5817-1050

**ON Semiconductor Website:** [www.onsemi.com](http://www.onsemi.com)  
**Order Literature:** <http://www.onsemi.com/orderlit>  
For additional information, please contact your local  
Sales Representative

# Mouser Electronics

Authorized Distributor

Click to View Pricing, Inventory, Delivery & Lifecycle Information:

[ON Semiconductor:](#)

[FAN4860UC54X](#) [FAN4860UC5X](#) [FAN4860UMP5X](#) [FAN4860UC33X](#)