

RA4 Series

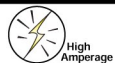

ROCKER

Panel Cutout

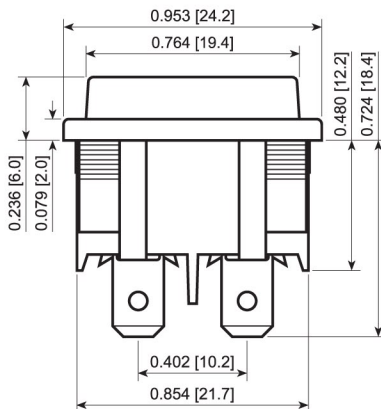
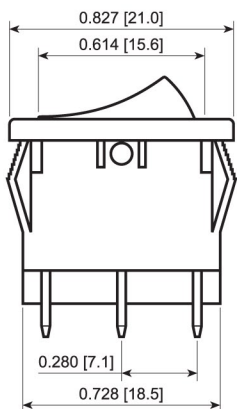
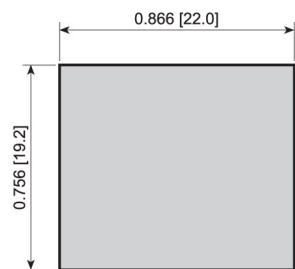
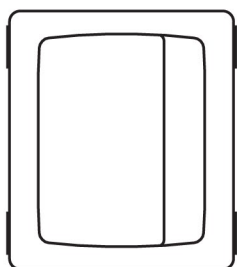

Actuator Options

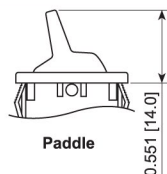

Paddle

Illumination Options

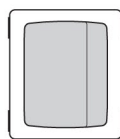

Full

Water Protection Options

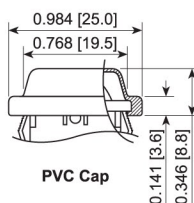

PVC Cap

FEATURES:

- High Rating with UL and VDE Approvals
- Curved and Paddle Actuator Options
- PVC Cap for Dust and Water Protection

SPECIFICATIONS:

RATING: RATING OPTION C:

- 16A 125VAC [UL, cUL]
- 10A 250VAC [UL, cUL]
- 1/3HP 125/250VAC 105°C [UL, cUL]
- 10(4)A 250V- T125 1E4 [VDE]
- 10(2)A 250V- T85 5E4 [VDE]

RATING OPTION 3:

- 10A 125VAC [UL, cUL]
- 6(2)A 250V- T125 1E4 [VDE]

TEMPERATURE: -20°C to 105°C [UL, cUL]
-20°C to 125°C [VDE]

ELECTRICAL LIFE: 10,000 Cycles

CONTACT RESISTANCE: 35mΩ Max.

INSULATION RESISTANCE: 100MΩ Min. at 500VDC

DIELECTRIC STRENGTH: 1,500VAC for 1 Minute

INGRESS PROTECTION: IP54 with PVC Cap

MATERIALS:

BODY: Polyamide 6/6, UL94 V-2

ACTUATOR: Polyamide 6/6, UL94 V-2

CONTACTS: Silver Alloy

TERMINALS: Silver Plated Copper

Terminal Options

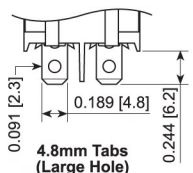

4.8mm Tabs (Large Hole)

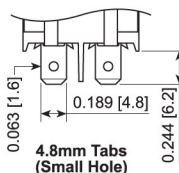

4.8mm Tabs (Small Hole)

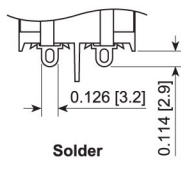

Solder

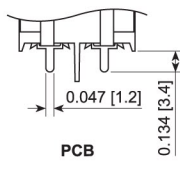

PCB



RAP41232200



RA41231121



RA42631100



RA41231188

| Series | Terminal | Function | Rating | Body Color | Actuator Color | Marking Color | Marking Type | Lens Style | Lens Color | Lamp Voltage |
|---|---|--|----------------------------------|--|--|---|---|------------|--|---|
| <input type="checkbox"/> RA4 - Curved Actuator <input type="checkbox"/> RA4P - Paddle Actuator | <input type="checkbox"/> 1 - 4.8mm Tab (Small Hole) <input type="checkbox"/> 3 - PCB <input type="checkbox"/> 5 - Solder <input type="checkbox"/> 8 - 4.8mm Tab (Large Hole) | 1 Pole: 1 - Off-On 3 - On-On 4 - Off-(On) 5 - On-Off-On A - On-(Off) B - On-(On) 2 Pole: 2 - Off-On (*) G - On-On E - Off-(On) 6 - On-Off-On F - On-(Off) H - On-(On) | 3 - 10A 125VAC C - 16A 125VAC | 1 - Black 2 - White 3 - Almond 4 - Grey | 1 - Black 2 - White 3 - Almond 4 - Grey 5 - Orange 7 - Blue 8 - Green 9 - Red | 0 - None 1 - Black 2 - White 8 - Red | 0 - None 1 - I/O Vert. 2 - ON/OFF/I/O Vert. 3 - ON/OFF Vert. 4 - ON/OFF Horiz. 9 - I/O/II Horiz. S - I/O/II Vert. R - I/O Horiz. | 1 - Full | 0 - Clear 1 - Red 2 - Amber 3 - Green 4 - Blue | 3 - 6V 4 - 12V 6 - 125V 7 - 250V |

Note: * = Option Available with Illumination

Custom Colors and Markings Available Upon Request For Illuminated Switches Only

EXAMPLE PART NUMBERS:
 RA412C1100 2P Off-On Black Body/Actuator, 4.8mm Tab, No Marking
 RA412C1121 2P Off-On Black Body/Actuator, 4.8mm Tab, I/O Vert.

SPECIFICATIONS SUBJECT TO CHANGE WITHOUT NOTICE

Mouser Electronics

Authorized Distributor

Click to View Pricing, Inventory, Delivery & Lifecycle Information:

E-Switch:

[RA41231121](#) [RA41631100](#) [RA412C1100](#) [RA41G31100](#) [RA456C112S](#) [RA45A31100](#) [RA456C112Z73](#)
[RA45131100](#) [RA456C1129](#) [RA45HC1911](#) [RA4P1GC1100](#) [RA416C1100](#) [RA456C112Z74](#) [RA45HC1121](#)
[RA41131121](#)