



Windows Vista-Compliant Class D Speaker Amplifiers with DirectDrive Headphone Amplifiers

General Description

The MAX9791 combines a stereo 2W Class D power amplifier, a stereo 180mW DirectDrive® headphone amplifier, and a 120mA low-dropout (LDO) linear regulator in a single device. The MAX9792 combines a mono 3W Class D power amplifier, a stereo 180mW DirectDrive headphone amplifier, and a 120mA LDO linear regulator in a single device.

The MAX9791/MAX9792 feature Maxim's DirectDrive headphone amplifier architecture that produces a ground-referenced output from a single supply, eliminating the need for large DC-blocking capacitors, saving cost, board space, and component height. High 107dB DC PSRR and low 0.006% THD+N ensure clean, low-distortion amplification of the audio signal.

The ground sense feature senses and corrects for the voltage difference between the output jack ground and device signal ground. This feature minimizes headphone amplifier crosstalk by sensing the impedance in the ground return trace and correcting for it at the output jack. This feature also minimizes ground-loop noise when the output socket is used as a line out connection to other grounded equipment (for example, a PC connected to a home hi-fi system).

The MAX9791/MAX9792 feature low RF susceptibility, allowing the amplifiers to successfully operate in close proximity to wireless applications. The MAX9791/MAX9792 Class D amplifiers feature Maxim's spread-spectrum modulation and active emissions limiting circuitry. Industry-leading click-and-pop suppression eliminates audible transients during power-up and shutdown cycles.

The MAX9791/MAX9792 wake-on-beep feature wakes up the speaker and headphone amplifiers when a qualified beep signal is detected at the BEEP input.

For maximum flexibility, separate speaker and headphone amplifier control inputs provide independent shutdown of the speaker and headphone amplifiers. Additionally the LDO can be enabled independently of the audio amplifiers.

The MAX9791/MAX9792 feature thermal-overload and output short-circuit protection. The devices are available in 28-pin TQFN packages and are specified over the -40°C to +85°C extended temperature range.

Applications

Notebook Computers
Tablet PCs
Portable Multimedia Players

DirectDrive is a registered trademark of Maxim Integrated Products, Inc.

Windows Vista is a registered trademark of Microsoft Corp.



Features

- ◆ Windows Vista® Premium Compliant
- ◆ Low EMI Filterless Class D Speaker Amplifiers Pass EN55022B Emissions Limit with 30cm of Speaker Cable
- ◆ 180mW DirectDrive Headphone Amplifier
- ◆ Excellent RF Immunity
- ◆ Integrated 120mA LDO
- ◆ Eliminates Headphone Ground Loop Noise
- ◆ Wake-on-Beep Function
- ◆ Click-and-Pop Suppression
- ◆ Short-Circuit and Thermal-Overload Protection
- ◆ Thermally Efficient, Space-Saving Package 28-Pin TQFN-EP (4mm x 4mm x 0.75mm)

Ordering Information

PART	STEREO/MONO	LDO OUTPUT	PIN-PACKAGE
MAX9791AETI+	Stereo	4.75V	28 TQFN-EP*
MAX9791BETI+	Stereo	3.3V	28 TQFN-EP*
MAX9791CETI+	Stereo	1.8V	28 TQFN-EP*
MAX9792AETI+	Mono	4.75V	28 TQFN-EP*
MAX9792CETI+	Mono	1.8V	28 TQFN-EP*

Note: All devices are specified over the -40°C to +85°C extended temperature range.

+Denotes a lead(Pb)-free/RoHS-compliant package.

*EP = Exposed pad.

Simplified Block Diagrams

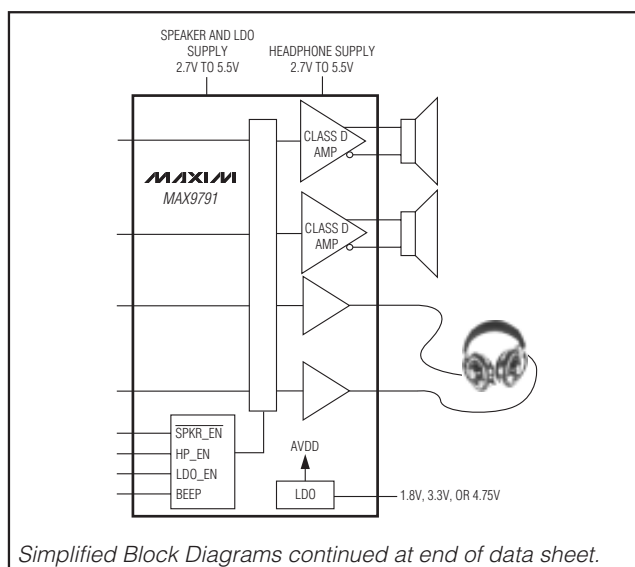

MAX9791/MAX9792

Windows Vista-Compliant Class D Speaker Amplifiers with DirectDrive Headphone Amplifiers

ABSOLUTE MAXIMUM RATINGS

Supply Voltage (AVDD, PVDD, HPVDD to GND).....	-0.3V to +6.0V
(AVDD to PVDD)	±0.3V
GND to PGND, CPGND	±0.3V
CPVSS, C1N to GND	-6.0V to + 0.3V
HPL, HPR to CPVSS	-0.3V to lower of (HPVDD - CPVSS + 0.3V) and +9V
HPL, HPR to HPVDD.....	+0.3V to the higher of (CPVSS - HPVDD - 0.3V) and -9V
COM, SENSE	-0.3V to + 0.3V
Any Other Pin	-0.3V to (AVDD + 0.3V)
Duration of Short Circuit between OUT_+, OUT_- and GND, PGND, AVDD, or PVDD.....	Continuous
Duration of Short Circuit between LDO_OUT and AVDD, GND (Note 1)	Continuous
Duration of Short Circuit between HPR, HPL and GND	Continuous
Continuous Current (PVDD, OUT_+, OUT_-, PGND).....	1.7A
Continuous Current (C1N, C1P, CPVSS, AVDD, HPVDD, LDO_OUT, HPR, HPL)850mA

Continuous Input Current (All Other Pins)	±20mA
Continuous Power Dissipation (T _A = +70°C)	
28-Pin Thin QFN Single-Layer Board (derate 20.8mW/°C above +70°C).....	1667mW
Junction-to-Ambient Thermal Resistance (θ _{JA}) (Note 2)	40°C/W
Junction-to-Case Thermal Resistance (θ _{JC}) (Note 2)	2.7°C/W
28-Pin Thin QFN Multilayer Board (derate 28.6mW/°C above +70°C).....	2286mW
Junction-to-Ambient Thermal Resistance (θ _{JA}) (Note 2)	35°C/W
Junction-to-Case Thermal Resistance (θ _{JC}) (Note 2)	2.7°C/W
ESD Protection, Human Body Model.....	±2kV
Operating Temperature Range	-40°C to +85°C
Junction Temperature.....	+150°C
Storage Temperature Range	-65°C to +150°C
Lead Temperature (soldering, 10s)	+300°C

Note 1: If short is present at power-up.

Note 2: Package thermal resistances were obtained using the method described in JEDEC specification JESD51-7, using a four-layer board. For detailed information on package thermal considerations, refer to www.maxim-ic.com/thermal-tutorial.

Stresses beyond those listed under "Absolute Maximum Ratings" may cause permanent damage to the device. These are stress ratings only, and functional operation of the device at these or any other conditions beyond those indicated in the operational sections of the specifications is not implied. Exposure to absolute maximum rating conditions for extended periods may affect device reliability.

ELECTRICAL CHARACTERISTICS

(V_{AVDD} = V_{PVDD} = V_{HPVDD} = 5V, V_{GND} = V_{PGND} = V_{CPGND} = 0, I_{LDO_OUT} = 0, C_{LDO} = 2μF (C_{LDO} = 4μF for 1.8V LDO option), C₁ = C₂ = 1μF, R_L = ∞, unless otherwise specified. R_{IN1} = 20kΩ (A_{VSPKR} = 12dB), R_{IN2} = 40.2kΩ (A_{VHP} = 0dB), C_{IN1} = 470nF, C_{IN2} = C_{COM} = 1μF, T_A = T_{MIN} to T_{MAX}, unless otherwise noted. Typical values are at T_A = +25°C.) (Note 3)

PARAMETER	SYMBOL	CONDITIONS			MIN	TYP	MAX	UNITS
GENERAL								
Supply Voltage	V _{AVDD} , V _{PVDD}	Guaranteed by PSRR test (Note 4)			2.7		5.5	V
Headphone Supply Voltage	V _{HPVDD}	Guaranteed by PSRR test			2.7		5.5	V
Undervoltage Lockout	UVLO						2.65	V
Quiescent Current	I _{AVDD} + I _{PVD} + I _{HPVDD}	MAX9791	SPKR_EN	HP_EN	LDO_EN			
			1	0	1	250	400	μA
			1	1	0	4.4	6	mA
		0	0	0	10.5	15		
		0	1	0	14.4	21		
		MAX9792	1	0	1	250	400	μA
			1	1	0	4.4	6	mA
0	0		0	10.5	18			
0	1	0	14.4	24				
Shutdown Current	I _{SHDN}	SPKR_EN = 1.8V			3.3		7.3	μA
Bias Voltage	V _{BIAS}	HP_INR, HP_INL, SPKR_INR, SPKR_INL			0			V

Windows Vista-Compliant Class D Speaker Amplifiers with DirectDrive Headphone Amplifiers

MAX9791/MAX9792

ELECTRICAL CHARACTERISTICS (continued)

($V_{AVDD} = V_{PVDD} = V_{HPVDD} = 5V$, $V_{GND} = V_{PGND} = V_{CPGND} = 0$, $I_{LDO_OUT} = 0$, $C_{LDO} = 2\mu F$ ($C_{LDO} = 4\mu F$ for 1.8V LDO option), $C1 = C2 = 1\mu F$, $R_L = \infty$, unless otherwise specified. $R_{IN1} = 20k\Omega$ ($A_{VSPKR} = 12dB$), $R_{IN2} = 40.2k\Omega$ ($A_{VHP} = 0dB$), $C_{IN1} = 470nF$, $C_{IN2} = C_{COM} = 1\mu F$, $T_A = T_{MIN}$ to T_{MAX} , unless otherwise noted. Typical values are at $T_A = +25^\circ C$.) (Note 3)

PARAMETER	SYMBOL	CONDITIONS	MIN	TYP	MAX	UNITS
Shutdown to Full Operation	t_{ON}			0.4		ms
Overtemperature Threshold				+150		$^\circ C$
SPEAKER AMPLIFIER						
Output Power	P_{OUT}	THD+N = 1%, f = 1kHz, $T_A = +25^\circ C$ (Note 5)	$R_L = 4\Omega$ (MAX9791)		1.7	W
			$R_L = 8\Omega$ (MAX9791)		1.2	
			$R_L = 3\Omega$ (MAX9792)		3	
		THD+N = 10%, f = 1kHz, $T_A = +25^\circ C$ (Note 5)	$R_L = 4\Omega$ (MAX9791)		2.2	
			$R_L = 8\Omega$ (MAX9791)		1.5	
			$R_L = 3\Omega$ (MAX9792)		3.7	
Total Harmonic Distortion Plus Noise	THD+N	$R_L = 8\Omega$, $P_{OUT} = 500mW$, f = 1kHz (Note 5)		0.04		%
		$R_L = 4\Omega$, $P_{OUT} = 500mW$, f = 1kHz (Note 5)		0.03		
Power-Supply Rejection Ratio	PSRR	$V_{AVDD} = V_{PVDD} = 2.7V$ to $5.5V$, $T_A = +25^\circ C$		60	80	dB
		f = 217Hz, 200mV _{P-P}			73	
		f = 1kHz, 200mV _{P-P}			75	
		f = 10kHz, 200mV _{P-P}			62	
Feedback Impedance	R_{FSKR}	Guaranteed by design		20		k Ω
Gain	A_V	$R_{IN1} = 20k\Omega$		12		dB
Output Offset Voltage	V_{OS}	Measured between OUT_{+} and OUT_{-} , $T_A = +25^\circ C$		± 3	± 10	mV
Click-and-Pop Level	K_{CP}	$R_L = 8\Omega$, peak voltage, A-weighted, 32 samples per second (Notes 5, 6, and 7)	Into shutdown		-52.4	dBV
			Out of shutdown		-54	
Signal-to-Noise Ratio	SNR	$R_L = 8\Omega$ $P_{OUT} = 1.2W$ $f_{IN} = 1kHz$, (Note 5)	A-weighted		98	dB
			20Hz to 20kHz		94	
Noise	V_N	A-weighted		38		μV_{RMS}
Crosstalk		L to R, R to L, $R_L = 8\Omega$, $V_{IN} = -20dBFS = 100mV_{RMS}$, $f_{IN} = 1kHz$ (Note 5)		78		dB
		L to R, R to L, $R_L = 8\Omega$, $V_{IN} = -20dBFS = 100mV_{RMS}$, $f_{IN} = 15kHz$ (Note 5)		70		
		HP to SPKR, $R_{LSPKR} = 8\Omega$, $P_{HP} = 20mW$, $R_{LHP} = 32\Omega$, $f_{IN} = 1kHz$ (Note 5)		77		

Windows Vista-Compliant Class D Speaker Amplifiers with DirectDrive Headphone Amplifiers

ELECTRICAL CHARACTERISTICS (continued)

($V_{AVDD} = V_{PVDD} = V_{HPVDD} = 5V$, $V_{GND} = V_{PGND} = V_{CPGND} = 0$, $I_{LDO_OUT} = 0$, $C_{LDO} = 2\mu F$ ($C_{LDO} = 4\mu F$ for 1.8V LDO option), $C_1 = C_2 = 1\mu F$, $R_L = \infty$, unless otherwise specified. $R_{IN1} = 20k\Omega$ ($A_{VSPKR} = 12dB$), $R_{IN2} = 40.2k\Omega$ ($A_{VHP} = 0dB$), $C_{IN1} = 470nF$, $C_{IN2} = C_{COM} = 1\mu F$, $T_A = T_{MIN}$ to T_{MAX} , unless otherwise noted. Typical values are at $T_A = +25^\circ C$.) (Note 3)

PARAMETER	SYMBOL	CONDITIONS		MIN	TYP	MAX	UNITS
Class D Switching Frequency	f _{SPK}			948		1158	kHz
Spread-Spectrum Bandwidth					±15		kHz
Efficiency		P _{OUT} = 1.5W, f _{IN} = 1kHz, R _L = 8Ω (Note 5)			83		%
HEADPHONE AMPLIFIER							
Output Power	P _{OUT}	THD+N = 1%, f = 1kHz, T _A = +25°C	R _L = 16Ω	100			mW
			R _L = 32Ω	180			
Total Harmonic Distortion Plus Noise	THD+N	R _L = 32Ω, f _{IN} = 6kHz, 20kHz AES17, V _{IN} = -3dBFS = 212mVRMS		-78			dBFS
		R _L = 10kΩ, f _{IN} = 6kHz, 20kHz AES17, V _{IN} = -3dBFS = 500mVRMS		-87			
		R _L = 32Ω, P _{OUT} = 100mW, f = 1kHz		0.006			%
		R _L = 16Ω, P _{OUT} = 75mW, f = 1kHz		0.014			
Power-Supply Rejection Ratio	PSRR	V _{HPVDD} = 2.7V to 5.5V, T _A = +25°C		70	107		dB
		f = 1kHz, V _{RIPPLE} = 200mV _{P-P}		91			
		f = 10kHz, V _{RIPPLE} = 200mV _{P-P}		80			
Feedback Impedance	R _{FHP}			38.2	40.2	42.2	kΩ
Gain	A _V	R _{IN2} = 40.2kΩ		0			dB
Output Offset Voltage	V _{OS}	T _A = +25°C			±0.3	±3	mV
Click-and-Pop Level	K _{CP}	R _L = 32Ω, peak voltage, A-weighted, 32 samples per second (Notes 6, 7)	Into shutdown	-81			dBV
			Out of shutdown	-72.5			
Signal-to-Noise Ratio	SNR	R _L = 32Ω, P _{OUT} = 40mW, f _{IN} = 1kHz	A-weighted	102			dB
			20Hz to 20kHz	94			
Noise	V _N	A-weighted		8			μVRMS
Maximum Capacitive Load	C _L	No sustained oscillations		100			pF
Crosstalk		L to R, R to L, f _{IN} = 1kHz, COM and SENSE connected	R _L = 32Ω, V _{IN} = -20dBFS = 30mVRMS	82			dB
			R _L = 10kΩ, V _{IN} = -20dBFS = 0.7mVRMS	89			
		L to R, R to L, f _{IN} = 15kHz, COM and SENSE connected	R _L = 32Ω, V _{IN} = -20dBFS = 30mVRMS	64			
			R _L = 10kΩ, V _{IN} = -20dBFS = 70.7mVRMS	70			
		SPKR to HP, R _{LSPKR} = 8Ω, P _{SPKR} = 1W, R _{LHP} = 32Ω, f _{IN} = 1Hz		80			

Windows Vista-Compliant Class D Speaker Amplifiers with DirectDrive Headphone Amplifiers

MAX9791/MAX9792

ELECTRICAL CHARACTERISTICS (continued)

($V_{AVDD} = V_{PVDD} = V_{HPVDD} = 5V$, $V_{GND} = V_{PGND} = V_{CPGND} = 0$, $I_{LDO_OUT} = 0$, $C_{LDO} = 2\mu F$ ($C_{LDO} = 4\mu F$ for 1.8V LDO option), $C_1 = C_2 = 1\mu F$, $R_L = \infty$, unless otherwise specified. $R_{IN1} = 20k\Omega$ ($A_{VSPKR} = 12dB$), $R_{IN2} = 40.2k\Omega$ ($A_{VHP} = 0dB$), $C_{IN1} = 470nF$, $C_{IN2} = C_{COM} = 1\mu F$, $T_A = T_{MIN}$ to T_{MAX} , unless otherwise noted. Typical values are at $T_A = +25^\circ C$.) (Note 3)

PARAMETER	SYMBOL	CONDITIONS	MIN	TYP	MAX	UNITS
COM Input Range	V_{COM}	Inferred from CMRR test	-300		+300	mV
Common-Mode Rejection Ratio	CMRR	$-300mV \leq V_{COM} \leq +300mV$		60		dB
Slew Rate	SR			0.38		V/ μs
Charge-Pump Frequency	f_{OSC}			530		kHz
BEEP INPUT (LDO_EN = 1)						
Beep Signal Minimum	f_{BEEP}	Four-cycle count	215			Hz
Amplifier Turn-On Time	t_{ONBEEP}			0.4		ms
Amplifier Hold Time	$t_{HOLDBEEP}$		221	246	271	ms
LOW-DROPOUT LINEAR REGULATOR						
LDO Ground Current	I_{LDO}			0.25	0.4	mA
Output Current	I_{OUT}	Inferred from load regulation			120	mA
Current Limit	I_{LIM}			300		mA
Crosstalk		Speaker to LDO, $V_{LDO_OUT} = 4.75V$, $f = 1kHz$, $I_{LDO_OUT} = 10mA$, speaker $P_{OUT} = 1.2W$, $R_L = 8\Omega$ (Note 6)		-80		dB
Output-Voltage Accuracy		$V_{LDO_OUT} = 4.75V$			± 1.5	%
		$V_{LDO_OUT} = 3.3V$			± 1.5	
Dropout Voltage	V_{DO}	$V_{LDO_OUT} = 4.75V$, $T_A = +25^\circ C$ (Note 8)	$I_{OUT} = 50mA$	46		mV
			$I_{OUT} = 120mA$	106		
Startup Time				30		μs
Line Regulation		$V_{AVDD} = 5V$ to $5.5V$, $V_{LDO_OUT} = 4.75V$, $I_{LDO_OUT} = 1mA$, $C_{LDO} = 2\mu F$	-4.8	1.5	+4.8	mV/V
		$V_{AVDD} = 4.5V$ to $5.5V$, $V_{LDO_OUT} = 3.3V$, $I_{LDO_OUT} = 1mA$, $C_{LDO} = 2\mu F$	-4	0.2	+4	
		$V_{AVDD} = 3V$ to $5.5V$, $V_{LDO_OUT} = 1.8V$, $I_{LDO_OUT} = 1mA$, $C_{LDO} = 4\mu F$	-6.4	2.5	+6.4	
Load Regulation		$V_{LDO_OUT} = 4.75V$, $1mA < I_{LDO_OUT} < 120mA$		0.22		mV/mA
Ripple Rejection		$V_{RIPPLE} = 200mV_{P-P}$, $V_{LDO_OUT} = 4.75V$, $I_{LDO_OUT} = 10mA$	$f = 1kHz$	56		dB
			$f = 10kHz$	40		
Output-Voltage Noise		20Hz to 20kHz, $C_{LDO_OUT} = 2 \times 1\mu F$, $I_{LDO_OUT} = 120mA$		130		μV_{RMS}
DIGITAL INPUTS (SPKR_EN, HP_EN, LDO_EN, BEEP)						
Input-Voltage High	V_{INH}		1.4			V
Input-Voltage Low	V_{INL}				0.4	V
Input Bias Current			-1		+1	μA

Windows Vista-Compliant Class D Speaker Amplifiers with DirectDrive Headphone Amplifiers

ELECTRICAL CHARACTERISTICS (continued)

($V_{AVDD} = V_{PVDD} = V_{HPVDD} = 5V$, $V_{GND} = V_{PGND} = V_{CPGND} = 0$, $I_{LDO_OUT} = 0$, $C_{LDO} = 2\mu F$ ($C_{LDO} = 4\mu F$ for 1.8V LDO option), $C1 = C2 = 1\mu F$, $R_L = \infty$, unless otherwise specified. $R_{IN1} = 20k\Omega$ ($AV_{SPKR} = 12dB$), $R_{IN2} = 40.2k\Omega$ ($AV_{HP} = 0dB$), $C_{IN1} = 470nF$, $C_{IN2} = C_{COM} = 1\mu F$, $T_A = T_{MIN}$ to T_{MAX} , unless otherwise noted. Typical values are at $T_A = +25^\circ C$.) (Note 3)

- Note 3:** All devices are 100% production tested at room temperature. All temperature limits are guaranteed by design.
- Note 4:** AVDD and PVDD must be tied together. If LDO is enabled, set AVDD and PVDD as specified in the Line Regulation row of the *Electrical Characteristics* table.
- Note 5:** Testing performed with a resistive load in series with an inductor to simulate an actual speaker load. For $R_L = 3\Omega$, $L = 22\mu H$. For $R_L = 4\Omega$, $L = 33\mu H$. For $R_L = 8\Omega$, $L = 68\mu H$.
- Note 6:** Specified at $T_A = +25^\circ C$ with an $8\Omega + 68\mu H$ load connected across BTL output for speaker amplifier. Specified at $T_A = +25^\circ C$ with a 32Ω resistive load connected between HPR, HPL and GND for headphone amplifier. Speaker and headphone mode transitions are controlled by $\overline{SPKR_EN}$ and HP_EN inputs, respectively.
- Note 7:** Amplifier Inputs AC-coupled to GND.
- Note 8:** Guaranteed by ATE characterization; limits are not production tested.

Typical Operating Characteristics

($V_{AVDD} = V_{PVDD} = V_{HPVDD} = 5V$, $V_{GND} = V_{PGND} = V_{CPGND} = 0$, $I_{LDO_OUT} = 0$, $C_{LDO} = 2 \times 1\mu F$, $C1 = C2 = 1\mu F$, $R_L = \infty$, unless otherwise specified. $R_{IN1} = 20k\Omega$ ($AV_{SPKR} = 12dB$), $R_{IN2} = 40.2k\Omega$ ($AV_{HP} = 0dB$), $C_{IN1} = 470nF$, $C_{IN2} = C_{COM} = 1\mu F$, measurement BW = 20kHz AES17, $T_A = +25^\circ C$, unless otherwise noted. Speaker mode: $\overline{SPKR_EN} = 0$, HP_EN = 0. Headphone mode: $\overline{SPKR_EN} = 1$, HP_EN = 1.)

SPEAKER

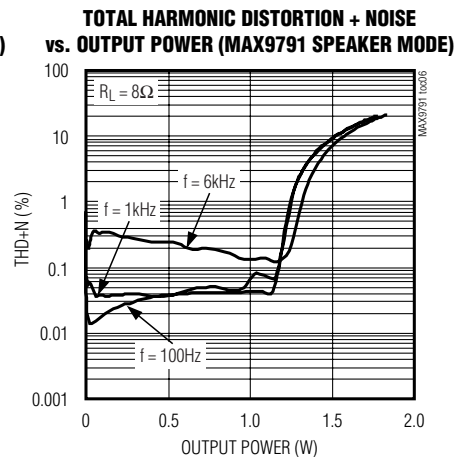
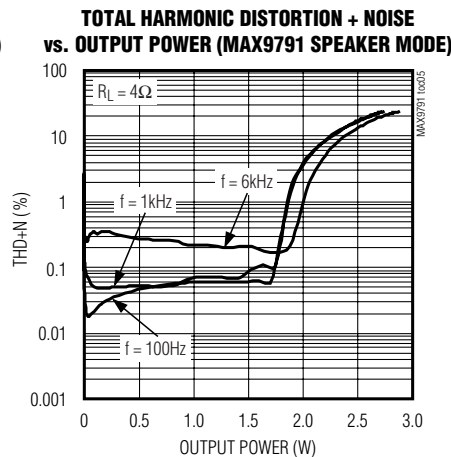
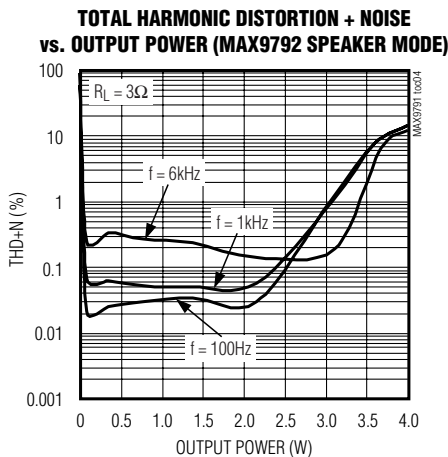
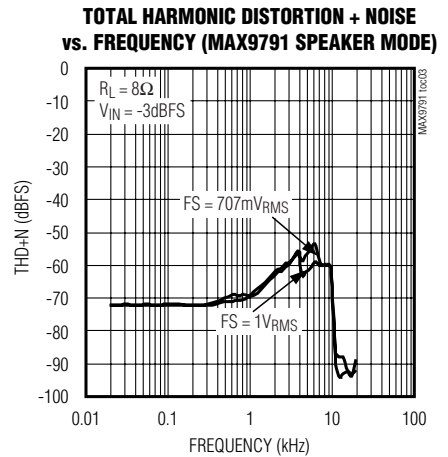
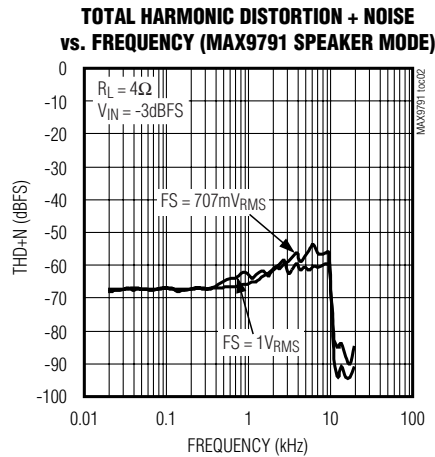
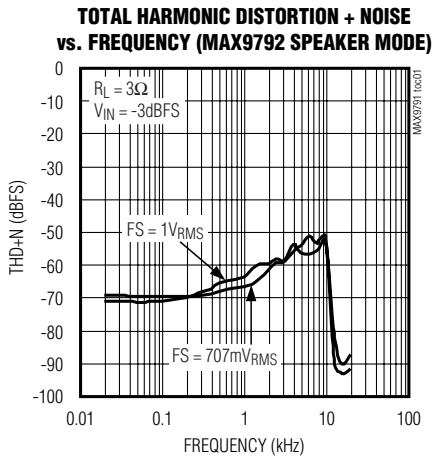

Windows Vista-Compliant Class D Speaker Amplifiers with DirectDrive Headphone Amplifiers

Typical Operating Characteristics (continued)

($V_{AVDD} = V_{PVDD} = V_{HPVDD} = 5V$, $V_{GND} = V_{PGND} = V_{CPGND} = 0$, $I_{LDO_OUT} = 0$, $C_{LDO} = 2 \times 1\mu F$, $C_1 = C_2 = 1\mu F$, $R_L = \infty$, unless otherwise specified. $R_{IN1} = 20k\Omega$ ($AV_{SPKR} = 12dB$), $R_{IN2} = 40.2k\Omega$ ($AV_{HP} = 0dB$), $C_{IN1} = 470nF$, $C_{IN2} = C_{COM} = 1\mu F$, measurement BW = 20kHz AES17, $T_A = +25^\circ C$, unless otherwise noted. Speaker mode: $SPKR_EN = 0$, $HP_EN = 0$. Headphone mode: $SPKR_EN = 1$, $HP_EN = 1$.)

SPEAKER

OUTPUT POWER vs. LOAD RESISTANCE (MAX9792 SPEAKER MODE)

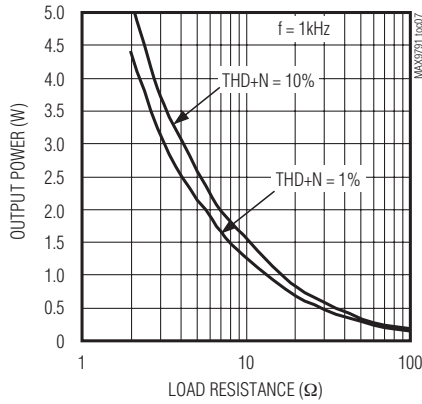

OUTPUT POWER vs. LOAD RESISTANCE (MAX9792 SPEAKER MODE)

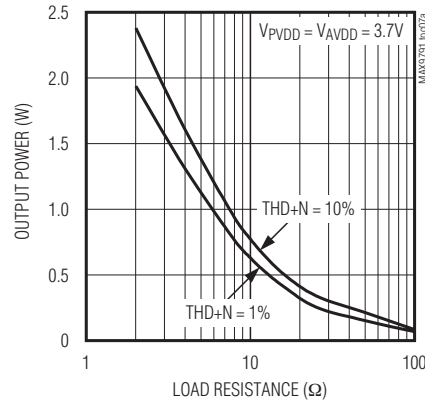

OUTPUT POWER vs. LOAD RESISTANCE (MAX9791 SPEAKER MODE)

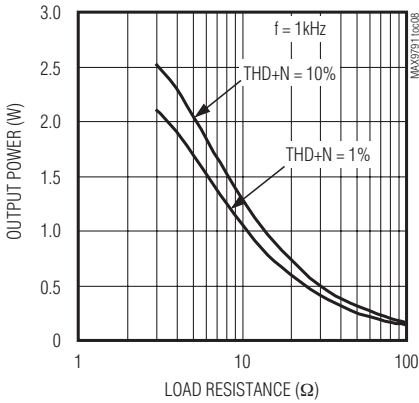

OUTPUT POWER vs. LOAD RESISTANCE (MAX9791 SPEAKER MODE)

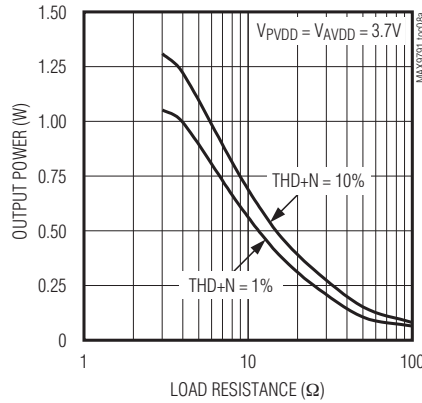

EFFICIENCY vs. OUTPUT POWER (MAX9792 SPEAKER MODE)

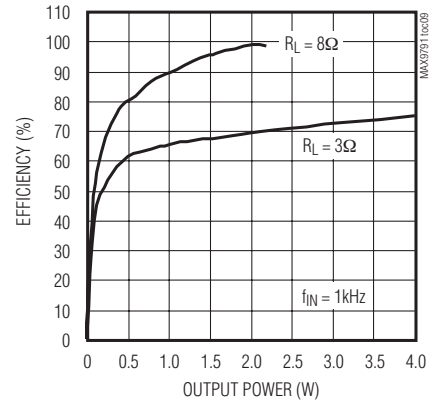

EFFICIENCY vs. OUTPUT POWER (MAX9792 SPEAKER MODE)

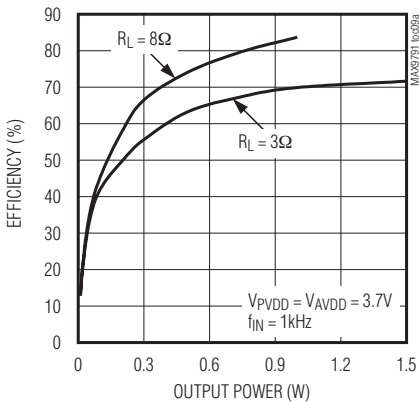

EFFICIENCY vs. OUTPUT POWER (MAX9791 SPEAKER MODE)

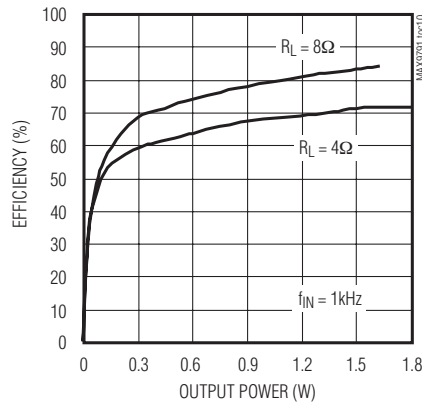

EFFICIENCY vs. OUTPUT POWER (MAX9791 SPEAKER MODE)

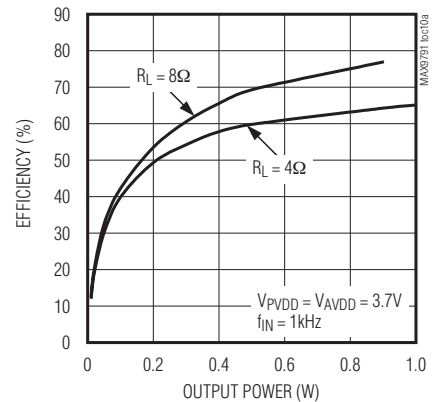

Windows Vista-Compliant Class D Speaker Amplifiers with DirectDrive Headphone Amplifiers

Typical Operating Characteristics (continued)

($V_{AVDD} = V_{PVDD} = V_{HPVDD} = 5V$, $V_{GND} = V_{PGND} = V_{CPGND} = 0$, $I_{LDO_OUT} = 0$, $C_{LDO} = 2 \times 1\mu F$, $C_1 = C_2 = 1\mu F$, $R_L = \infty$, unless otherwise specified. $R_{IN1} = 20k\Omega$ ($AV_{SPKR} = 12dB$), $R_{IN2} = 40.2k\Omega$ ($AV_{HP} = 0dB$), $C_{IN1} = 470nF$, $C_{IN2} = C_{COM} = 1\mu F$, measurement BW = 20kHz AES17, $T_A = +25^\circ C$, unless otherwise noted. Speaker mode: $SPKR_EN = 0$, $HP_EN = 0$. Headphone mode: $SPKR_EN = 1$, $HP_EN = 1$.)

SPEAKER

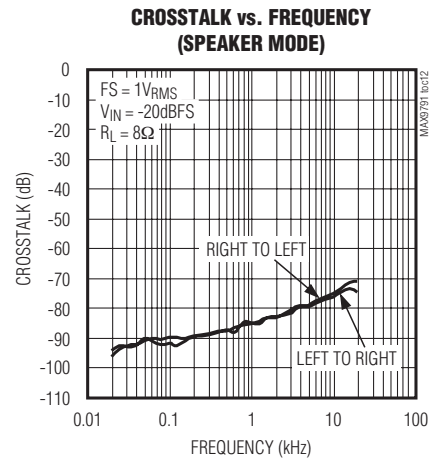
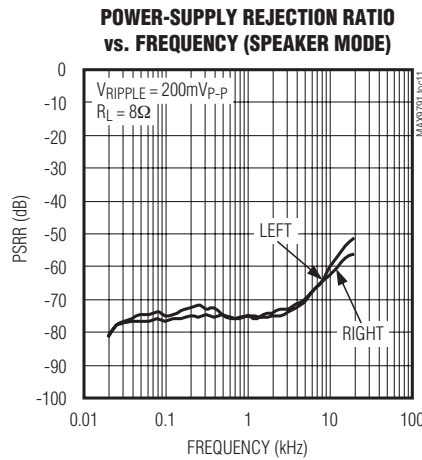
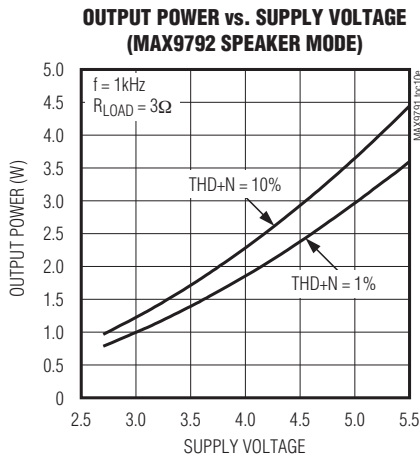
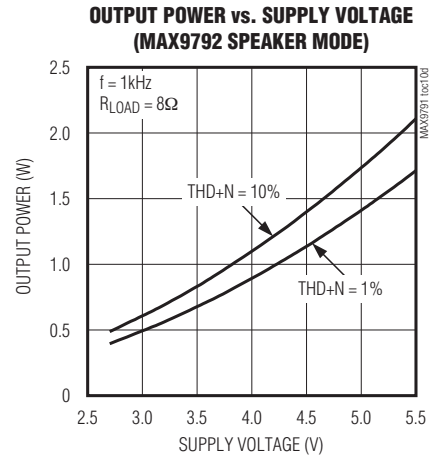
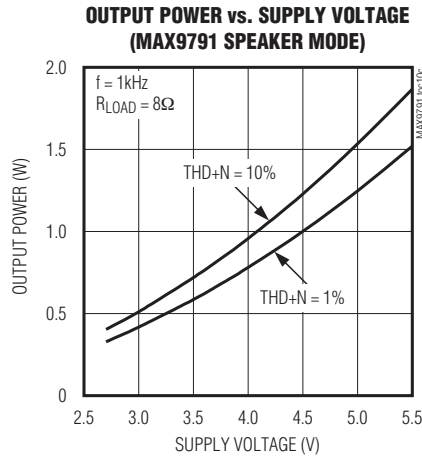
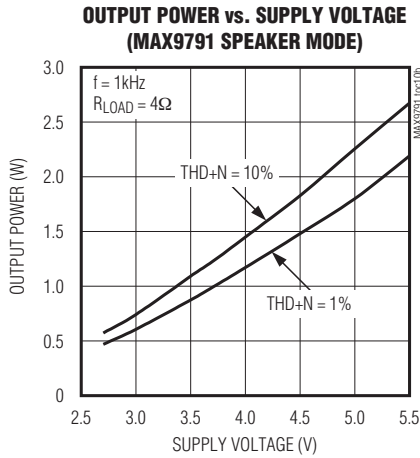

Windows Vista-Compliant Class D Speaker Amplifiers with DirectDrive Headphone Amplifiers

Typical Operating Characteristics (continued)

($V_{AVDD} = V_{PVDD} = V_{HPVDD} = 5V$, $V_{GND} = V_{PGND} = V_{CPGND} = 0$, $I_{LDO_OUT} = 0$, $C_{LDO} = 2 \times 1\mu F$, $C_1 = C_2 = 1\mu F$, $R_L = \infty$, unless otherwise specified. $R_{IN1} = 20k\Omega$ ($AV_{SPKR} = 12dB$), $R_{IN2} = 40.2k\Omega$ ($AV_{HP} = 0dB$), $C_{IN1} = 470nF$, $C_{IN2} = C_{COM} = 1\mu F$, measurement BW = 20kHz AES17, $T_A = +25^\circ C$, unless otherwise noted. Speaker mode: $SPKR_EN = 0$, $HP_EN = 0$. Headphone mode: $SPKR_EN = 1$, $HP_EN = 1$.)

SPEAKER

SPEAKER STARTUP WAVEFORM

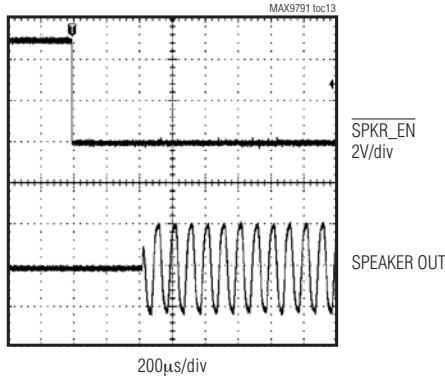

SPEAKER SHUTDOWN WAVEFORM

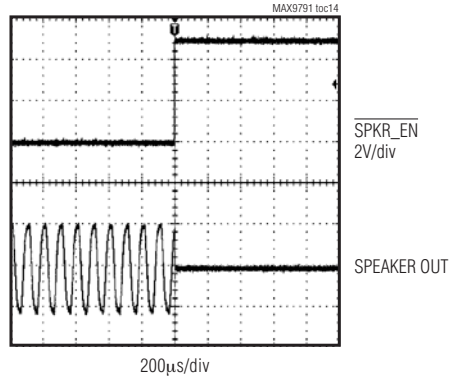

WIDEBAND OUTPUT SPECTRUM (SPEAKER MODE)

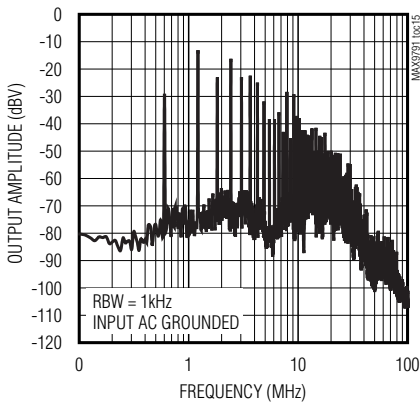

OUTPUT FREQUENCY SPECTRUM (SPEAKER MODE)

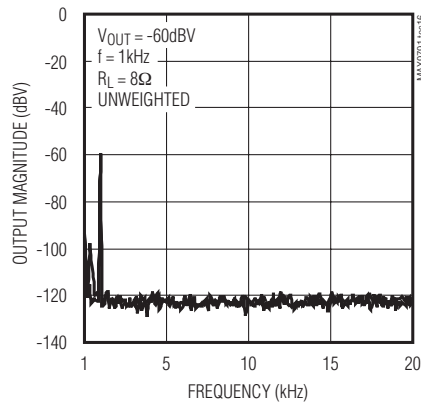

Windows Vista-Compliant Class D Speaker Amplifiers with DirectDrive Headphone Amplifiers

Typical Operating Characteristics (continued)

($V_{AVDD} = V_{PVDD} = V_{HPVDD} = 5V$, $V_{GND} = V_{PGND} = V_{CPGND} = 0$, $I_{LDO_OUT} = 0$, $C_{LDO} = 2 \times 1\mu F$, $C_1 = C_2 = 1\mu F$, $R_L = \infty$, unless otherwise specified. $R_{IN1} = 20k\Omega$ ($AV_{SPKR} = 12dB$), $R_{IN2} = 40.2k\Omega$ ($AV_{HP} = 0dB$), $C_{IN1} = 470nF$, $C_{IN2} = C_{COM} = 1\mu F$, measurement BW = 20kHz AES17, $T_A = +25^\circ C$, unless otherwise noted. Speaker mode: $SPKR_EN = 0$, $HP_EN = 0$. Headphone mode: $SPKR_EN = 1$, $HP_EN = 1$.)

HEADPHONE

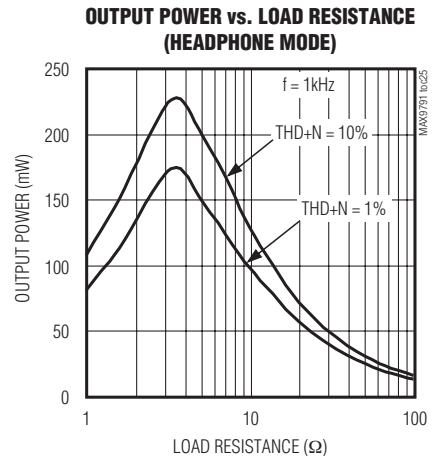
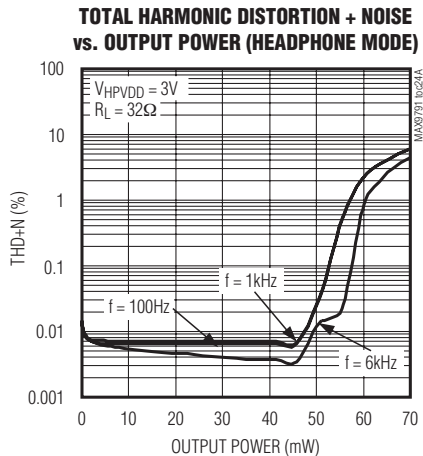
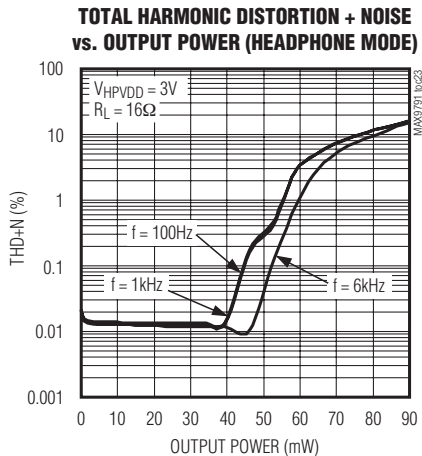
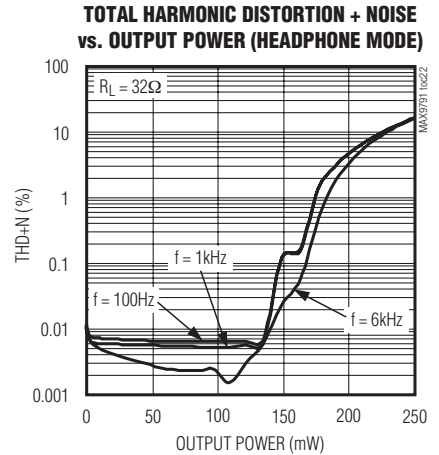
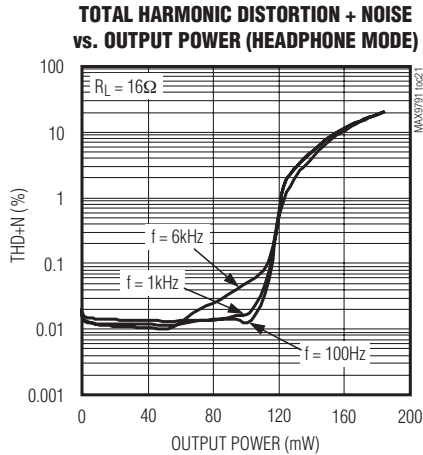
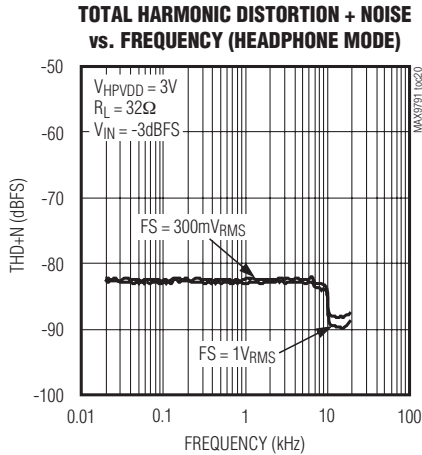
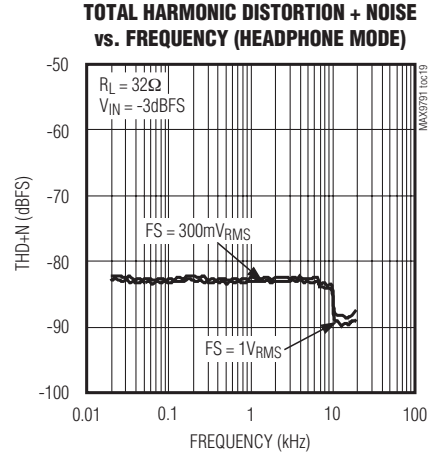
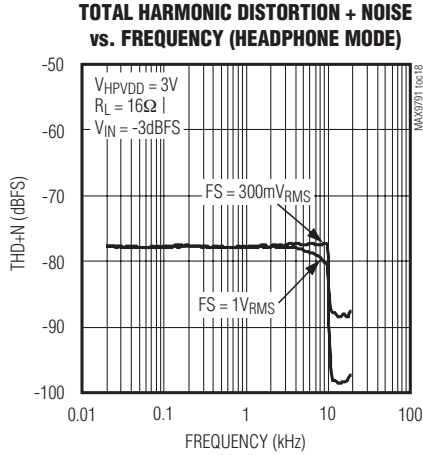
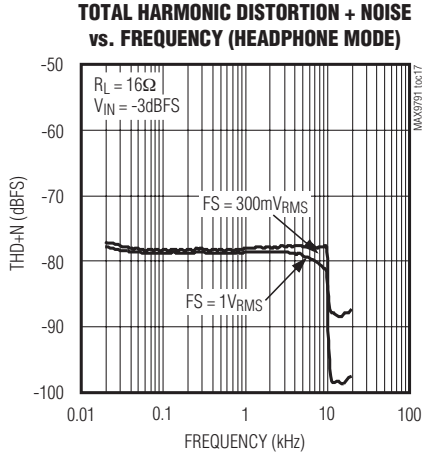

Windows Vista-Compliant Class D Speaker Amplifiers with DirectDrive Headphone Amplifiers

Typical Operating Characteristics (continued)

($V_{AVDD} = V_{PVDD} = V_{HPVDD} = 5V$, $V_{GND} = V_{PGND} = V_{CPGND} = 0$, $I_{LDO_OUT} = 0$, $C_{LDO} = 2 \times 1\mu F$, $C_1 = C_2 = 1\mu F$, $R_L = \infty$, unless otherwise specified. $R_{IN1} = 20k\Omega$ ($AV_{SPKR} = 12dB$), $R_{IN2} = 40.2k\Omega$ ($AV_{HP} = 0dB$), $C_{IN1} = 470nF$, $C_{IN2} = C_{COM} = 1\mu F$, measurement BW = 20kHz AES17, $T_A = +25^\circ C$, unless otherwise noted. Speaker mode: $SPKR_EN = 0$, $HP_EN = 0$. Headphone mode: $SPKR_EN = 1$, $HP_EN = 1$.)

HEADPHONE

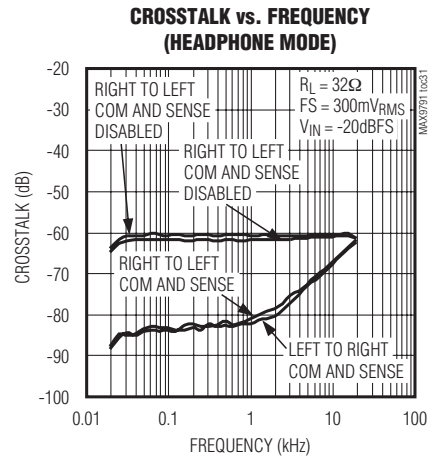
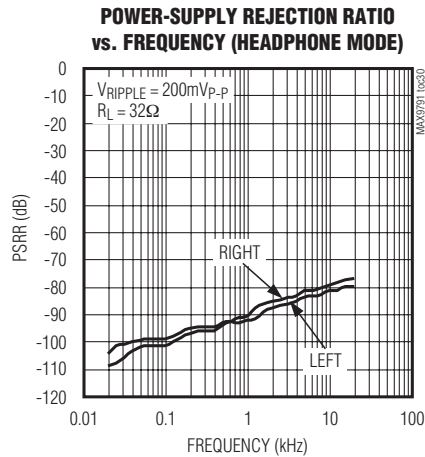
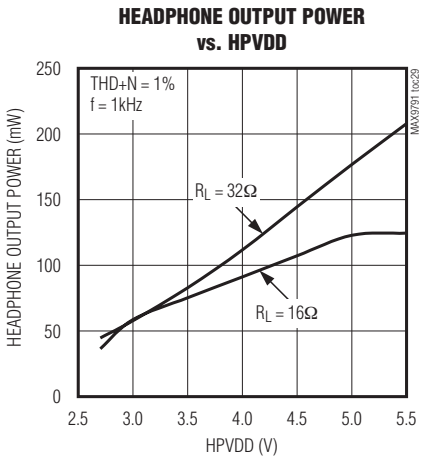
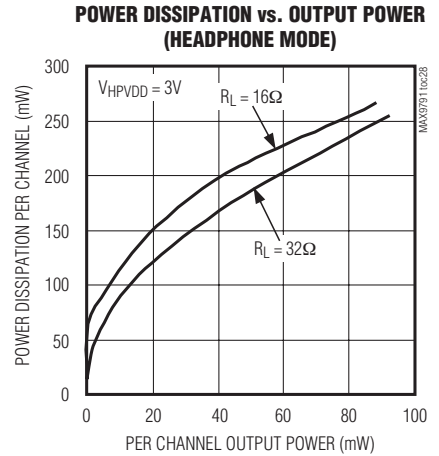
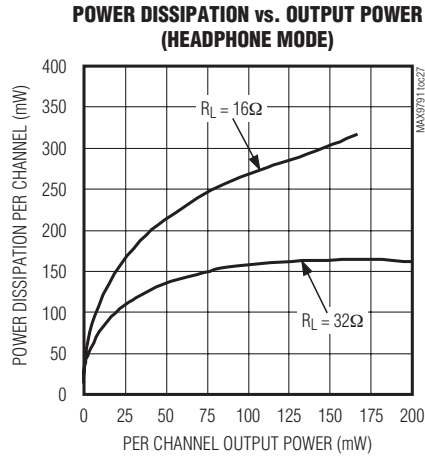
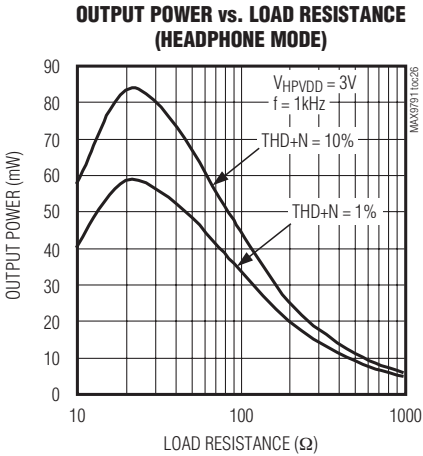

Windows Vista-Compliant Class D Speaker Amplifiers with DirectDrive Headphone Amplifiers

Typical Operating Characteristics (continued)

($V_{AVDD} = V_{PVDD} = V_{HPVDD} = 5V$, $V_{GND} = V_{PGND} = V_{CPGND} = 0$, $I_{LDO_OUT} = 0$, $C_{LDO} = 2 \times 1\mu F$, $C_1 = C_2 = 1\mu F$, $R_L = \infty$, unless otherwise specified. $R_{IN1} = 20k\Omega$ ($AV_{SPKR} = 12dB$), $R_{IN2} = 40.2k\Omega$ ($AV_{HP} = 0dB$), $C_{IN1} = 470nF$, $C_{IN2} = C_{COM} = 1\mu F$, measurement BW = 20kHz AES17, $T_A = +25^\circ C$, unless otherwise noted. Speaker mode: $SPKR_EN = 0$, $HP_EN = 0$. Headphone mode: $SPKR_EN = 1$, $HP_EN = 1$.)

HEADPHONE

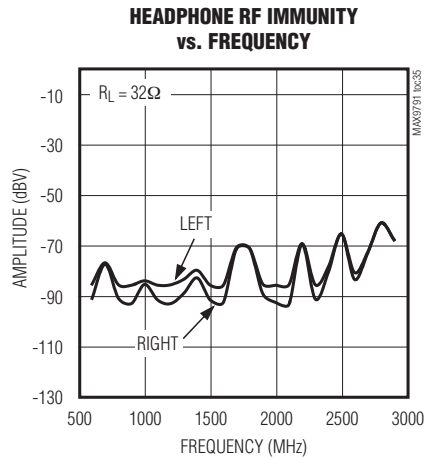
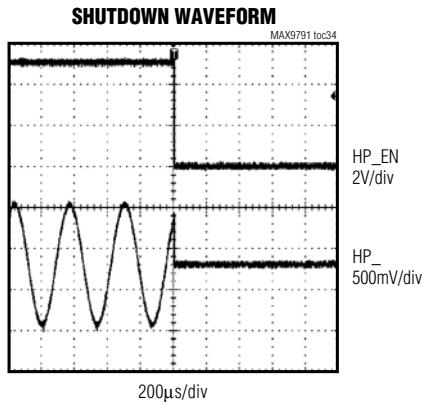
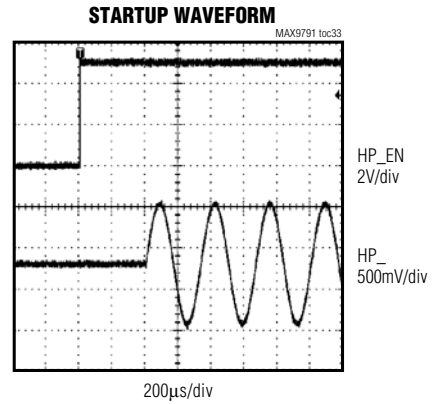
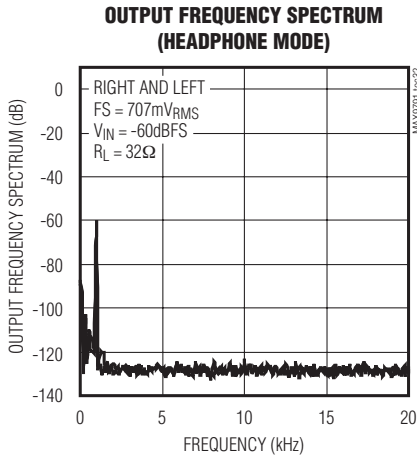

Windows Vista-Compliant Class D Speaker Amplifiers with DirectDrive Headphone Amplifiers

Typical Operating Characteristics (continued)

($V_{AVDD} = V_{PVDD} = V_{HPVDD} = 5V$, $V_{GND} = V_{PGND} = V_{CPGND} = 0$, $I_{LDO_OUT} = 0$, $C_{LDO} = 2 \times 1\mu F$, $C_1 = C_2 = 1\mu F$, $R_L = \infty$, unless otherwise specified. $R_{IN1} = 20k\Omega$ ($AV_{SPKR} = 12dB$), $R_{IN2} = 40.2k\Omega$ ($AV_{HP} = 0dB$), $C_{IN1} = 470nF$, $C_{IN2} = C_{COM} = 1\mu F$, measurement BW = 20kHz AES17, $T_A = +25^\circ C$, unless otherwise noted. Speaker mode: $SPKR_EN = 0$, $HP_EN = 0$. Headphone mode: $SPKR_EN = 1$, $HP_EN = 1$.)

LINE OUT

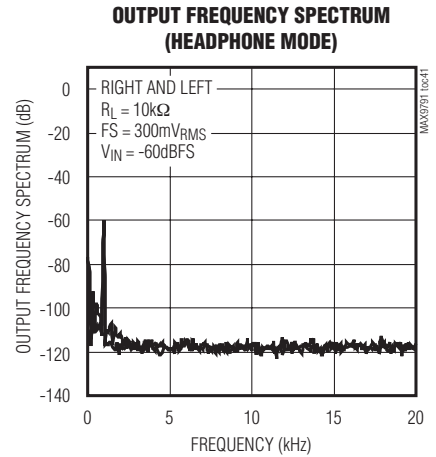
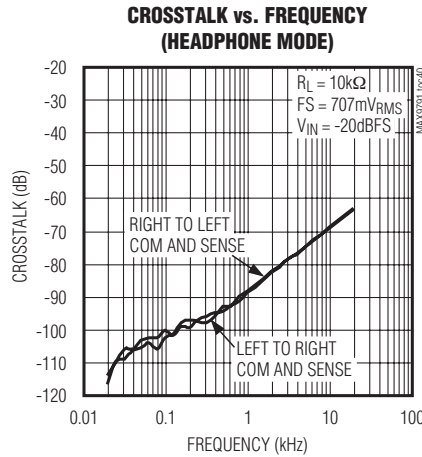
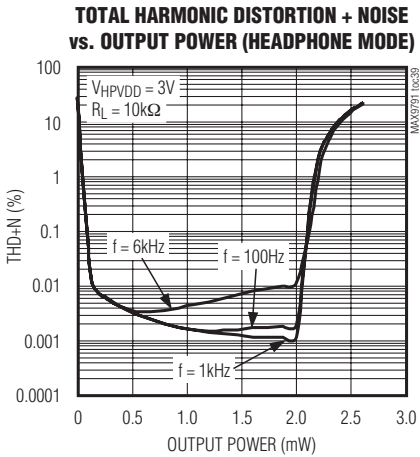
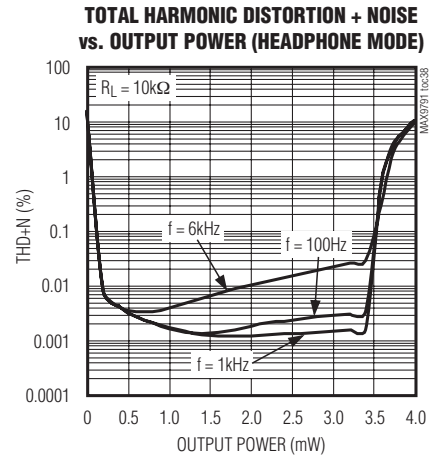
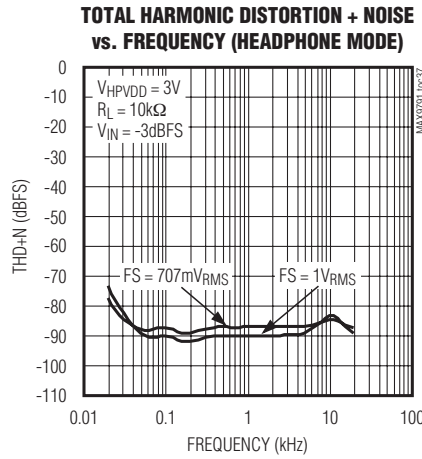
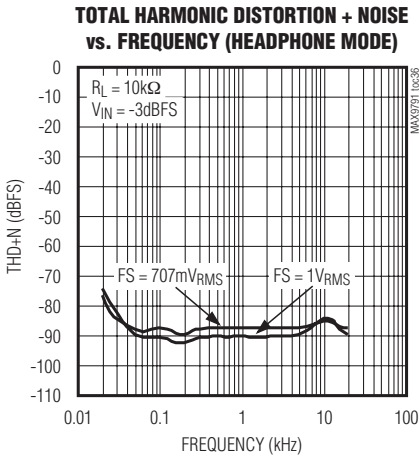

Windows Vista-Compliant Class D Speaker Amplifiers with DirectDrive Headphone Amplifiers

Typical Operating Characteristics (continued)

($V_{AVDD} = V_{PVDD} = V_{HPVDD} = 5V$, $V_{GND} = V_{PGND} = V_{CPGND} = 0$, $I_{LDO_OUT} = 0$, $C_{LDO} = 2 \times 1\mu F$, $C1 = C2 = 1\mu F$, $R_L = \infty$, unless otherwise specified. $R_{IN1} = 20k\Omega$ ($AV_{SPKR} = 12dB$), $R_{IN2} = 40.2k\Omega$ ($AV_{HP} = 0dB$), $C_{IN1} = 470nF$, $C_{IN2} = C_{COM} = 1\mu F$, measurement BW = 20kHz AES17, $T_A = +25^\circ C$, unless otherwise noted. Speaker mode: $SPKR_EN = 0$, $HP_EN = 0$. Headphone mode: $SPKR_EN = 1$, $HP_EN = 1$.)

GENERAL

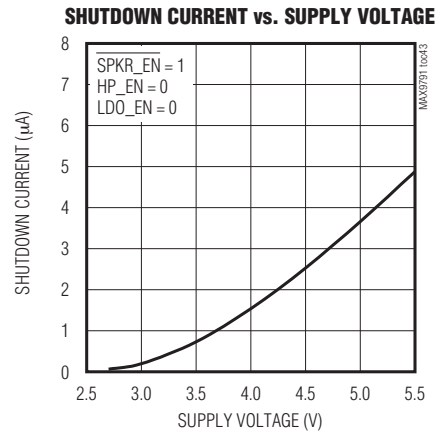
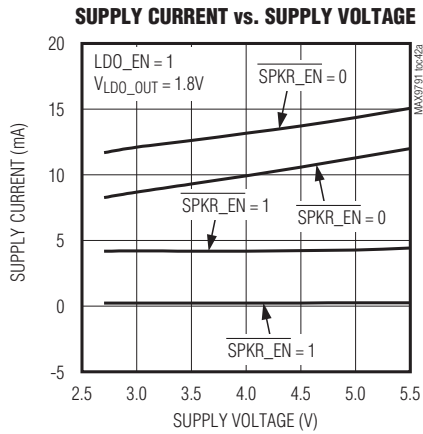
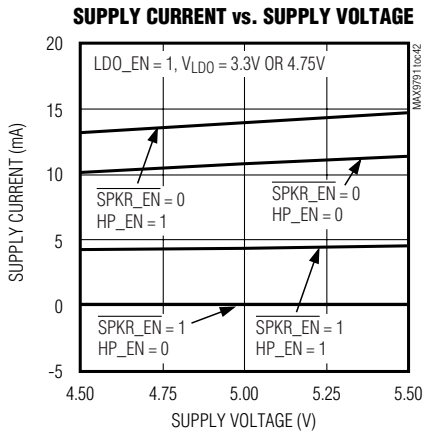

Windows Vista-Compliant Class D Speaker Amplifiers with DirectDrive Headphone Amplifiers

MAX9791/MAX9792

Typical Operating Characteristics (continued)

($V_{AVDD} = V_{PVDD} = V_{HPVDD} = 5V$, $V_{GND} = V_{PGND} = V_{CPGND} = 0$, $I_{LDO_OUT} = 0$, $C_{LDO} = 2 \times 1\mu F$, $C_1 = C_2 = 1\mu F$, $R_L = \infty$, unless otherwise specified. $R_{IN1} = 20k\Omega$ ($AV_{SPKR} = 12dB$), $R_{IN2} = 40.2k\Omega$ ($AV_{HP} = 0dB$), $C_{IN1} = 470nF$, $C_{IN2} = C_{COM} = 1\mu F$, measurement BW = 20kHz AES17, $T_A = +25^\circ C$, unless otherwise noted. Speaker mode: $SPKR_EN = 0$, $HP_EN = 0$. Headphone mode: $SPKR_EN = 1$, $HP_EN = 1$.)

LDO

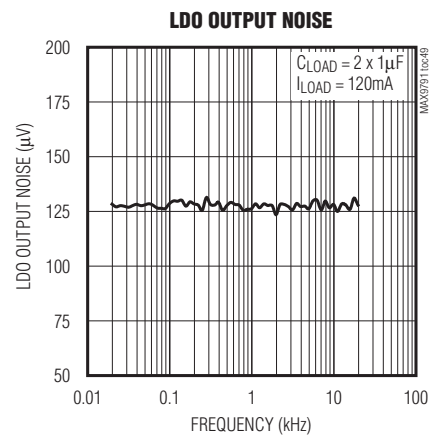
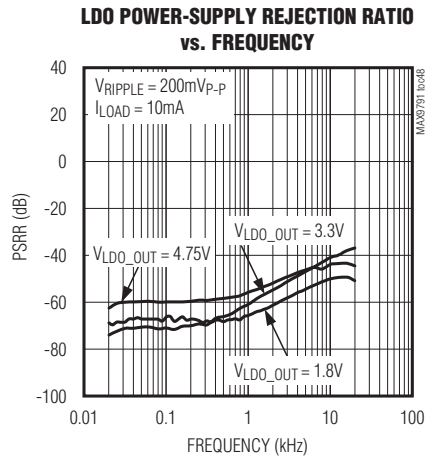
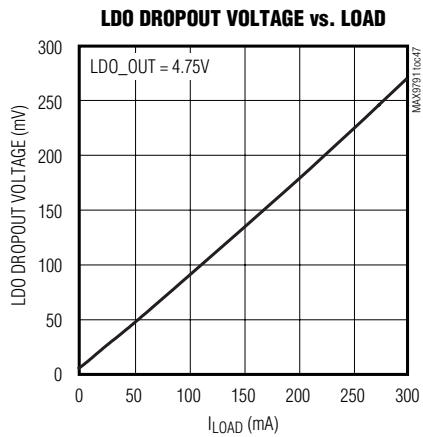
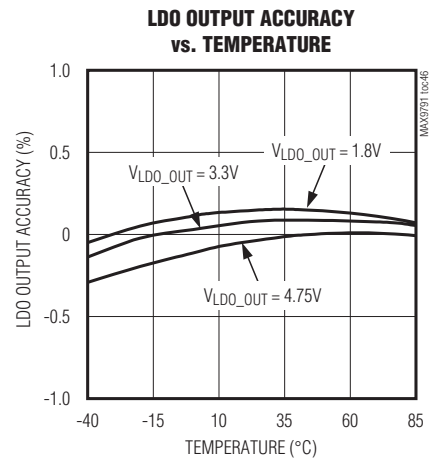
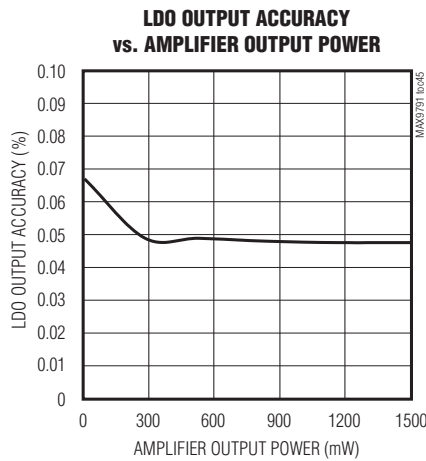
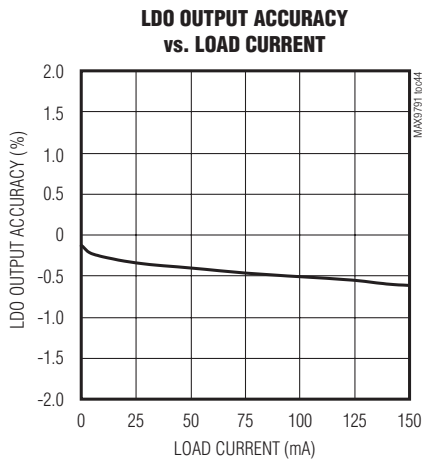

Windows Vista-Compliant Class D Speaker Amplifiers with DirectDrive Headphone Amplifiers

Typical Operating Characteristics (continued)

($V_{AVDD} = V_{PVDD} = V_{HPVDD} = 5V$, $V_{GND} = V_{PGND} = V_{CPGND} = 0$, $I_{LDO_OUT} = 0$, $C_{LDO} = 2 \times 1\mu F$, $C_1 = C_2 = 1\mu F$, $R_L = \infty$, unless otherwise specified. $R_{IN1} = 20k\Omega$ ($AV_{SPKR} = 12dB$), $R_{IN2} = 40.2k\Omega$ ($AV_{HP} = 0dB$), $C_{IN1} = 470nF$, $C_{IN2} = C_{COM} = 1\mu F$, measurement BW = 20kHz AES17, $T_A = +25^\circ C$, unless otherwise noted. Speaker mode: $SPKR_EN = 0$, $HP_EN = 0$. Headphone mode: $SPKR_EN = 1$, $HP_EN = 1$.)

LDO

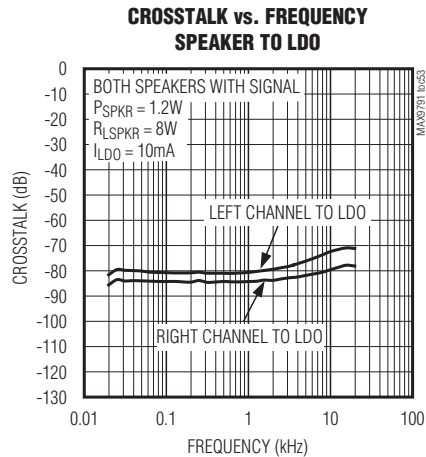
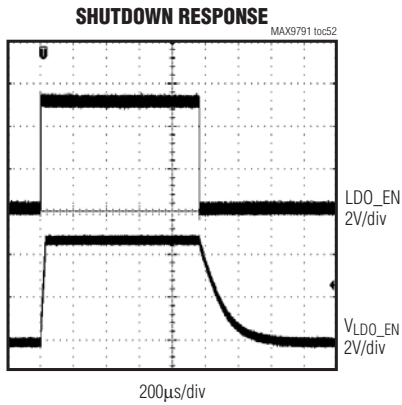
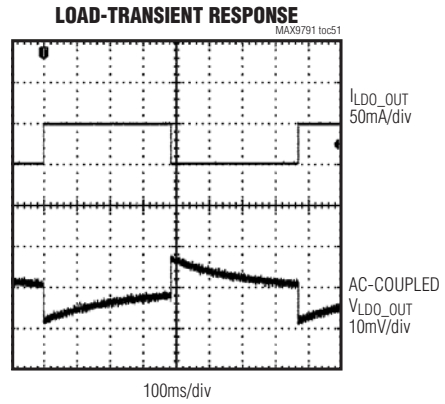
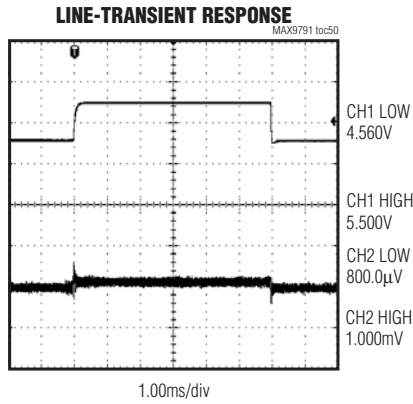

Windows Vista-Compliant Class D Speaker Amplifiers with DirectDrive Headphone Amplifiers

MAX9791 Pin Description

PIN	NAME	FUNCTION
1	SPKR_INL	Left-Channel Speaker Amplifier Input
2	HP_INR	Right-Channel Headphone Amplifier Input
3	HP_INL	Left-Channel Headphone Amplifier Input
4	COM	Common-Mode Voltage Sense Input
5	GND	Signal Ground. Star connect to PGND.
6	LDO_OUT	LDO Output. Bypass the MAX9791A/MAX9791B with two 1 μ F ceramic low ESR capacitors to GND. Bypass the MAX9791C with two 2 μ s ceramic low ESR capacitors to GND.
7	AVDD	Positive Power-Supply and LDO Input. Bypass with a 0.1 μ F and two 1 μ F capacitors to GND.
8	LDO_EN	LDO Enable. Connect LDO_EN to AVDD to enable the LDO.
9	HPR	Right-Channel Headphone Amplifier Output
10	HPL	Left-Channel Headphone Amplifier Output
11	SENSE	Headphone Ground Sense
12	CPVSS	Headphone Amplifier Negative Power Supply. Connect a 1 μ F capacitor between CPVSS and PGND.
13	C1N	Charge-Pump Flying Capacitor Negative Terminal. Connect a 1 μ F capacitor between C1P and C1N.
14	CPGND	Charge-Pump Ground. Connect directly to PGND plane.
15	C1P	Charge-Pump Flying Capacitor Positive Terminal. Connect a 1 μ F capacitor between C1P and C1N.
16	HPVDD	Headphone Amplifier Positive Power Supply. Connect a 10 μ F capacitor between HPVDD and PGND.
17, 26	PVDD	Speaker Amplifier Power-Supply Input. Bypass with a 0.1 μ F capacitor to PGND.
18	OUTL-	Left-Channel Speaker Amplifier Output, Negative Phase
19	OUTL+	Left-Channel Speaker Amplifier Output, Positive Phase
20, 23	PGND	Power Ground. Star connect to GND.
21	BEEP	PC Beep Input. Connect to GND if beep detection function is disabled.
22	HP_EN	Active-High Headphone Amplifier Enable
24	OUTR+	Right-Channel Speaker Amplifier Output, Positive Phase
25	OUTR-	Right-Channel Speaker Amplifier Output, Negative Phase
27	SPKR_EN	Active-Low Speaker Amplifier Enable
28	SPKR_INR	Right-Channel Speaker Amplifier Input
—	EP	Exposed Pad. Connect to GND.

MAX9791/MAX9792

Windows Vista-Compliant Class D Speaker Amplifiers with DirectDrive Headphone Amplifiers

MAX9792 Pin Description

PIN	NAME	FUNCTION
1, 5	GND	Signal Ground. Star connect to PGND.
2	HP_INR	Right-Channel Headphone Amplifier Input
3	HP_INL	Left-Channel Headphone Amplifier Input
4	COM	Common-Mode Voltage Sense Input
6	LDO_OUT	LDO Output. Bypass with two 1 μ F ceramic low ESR capacitors to GND.
7	AVDD	Positive Power Supply and LDO Input. Bypass with a 0.1 μ F and two 1 μ F capacitors to GND.
8	LDO_EN	LDO Enable. Connect LDO_EN to AVDD to enable the LDO.
9	HPR	Right-Channel Headphone Amplifier Output
10	HPL	Left-Channel Headphone Amplifier Output
11	SENSE	Headphone Ground Sense
12	CPVSS	Headphone Amplifier Negative Power Supply. Connect a 1 μ F capacitor between CPVSS and PGND.
13	C1N	Charge-Pump Flying Capacitor Negative Terminal. Connect a 1 μ F capacitor between C1P and C1N.
14	CPGND	Charge-Pump Ground. Connect directly to PGND plane.
15	C1P	Charge-Pump Flying Capacitor Positive Terminal. Connect a 1 μ F capacitor between C1P and C1N.
16	HPVDD	Headphone Amplifier Positive Power Supply. Connect a 10 μ F capacitor between HPVDD and PGND.
17, 26	PVDD	Speaker Amplifier Power-Supply Input. Bypass with a 0.1 μ F capacitor to PGND.
18, 25	OUT-	Speaker Amplifier Output, Negative Phase
19, 24	OUT+	Speaker Amplifier Output, Positive Phase
20, 23	PGND	Power Ground. Star connect to GND.
21	BEEP	PC Beep Input. Connect to GND if beep detection function is disabled.
22	HP_EN	Active-High Headphone Amplifier Enable
27	SPKR_EN	Active-Low Speaker Amplifier Enable
28	SPKR_IN	Speaker Amplifier Input
—	EP	Exposed Pad. Connect to GND.

Detailed Description

The MAX9791 combines a stereo 2W Class D power amplifier, a stereo 175mW DirectDrive headphone amplifier, and a 120mA LDO linear regulator in a single device. The MAX9792 combines a mono 3W Class D power amplifier, a stereo 175mW DirectDrive headphone amplifier, and a 120mA LDO linear regulator in a single device.

The MAX9791/MAX9792 feature wake-on-beep detection, comprehensive click-and-pop suppression, low-power shutdown mode, and excellent RF immunity. These devices incorporate an integrated LDO that serves as a clean power supply for CODEC or other circuits. The MAX9791/MAX9792 are Windows Vista Premium compliant. See Table 1 for a comparison of the Windows Vista Premium specifications and MAX9791/MAX9792 specifications.

The MAX9791/MAX9792 feature spread-spectrum modulation and active emission limiting circuitry that offers significant improvements to switch-mode amplifier technology. These devices offer Class AB performance with Class D efficiency in a minimal board-space solution.

The headphone amplifiers use Maxim's DirectDrive architecture to eliminate the bulky output DC-blocking capacitors required by traditional headphone amplifiers. A charge pump inverts the positive supply (HPVDD) to create a negative supply (CPVSS). The headphone amplifiers operate from these bipolar supplies with their outputs biased about GND. The benefit of the GND bias is that the amplifier outputs no longer have a DC component (typically $V_{DD}/2$). This feature eliminates the large DC-blocking capacitors required with conventional headphone amplifiers to

Windows Vista-Compliant Class D Speaker Amplifiers with DirectDrive Headphone Amplifiers

Table 1. Windows Premium Mobile Vista Specifications vs. MAX9791/MAX9792 Specifications

DEVICE TYPE	REQUIREMENT	WINDOWS PREMIUM MOBILE VISTA SPECIFICATIONS	MAX9791/MAX9792 TYPICAL PERFORMANCE
Analog Line-Out Jack (R _L = 10kΩ, FS = 0.707V _{RMS})	THD+N	≤ -65dB FS [100Hz, 20kHz]	87dBFS [100Hz, 20kHz]
	Dynamic range with signal present	≤ -80dBV, A-weighted [20Hz, 20kHz]	-98.9dB A-weighted [20Hz, 20kHz]
	Line output crosstalk	≤ -50dB [20Hz, 15kHz]	64dB [20Hz, 15kHz]
Analog Headphone-Out Jack (R _L = 32Ω, FS = 0.300V _{RMS})	THD+N	≤ -45dB FS [100Hz, 20kHz]	82dBFS [100Hz, 20kHz]
	Dynamic range with signal present	≤ -60dBV, A-weighted [20Hz, 20kHz]	-91.5dB A-weighted [20Hz, 20kHz]
	Headphone output crosstalk	≤ -50dB [20Hz, 15kHz]	64dB [20Hz, 15kHz]

Note: THD+N, dynamic range with signal present, and crosstalk should be measured in accordance with AES17 audio measurements standards.

conserve board space and system cost, as well as improve low-frequency response and distortion.

The MAX9791/MAX9792 amplifiers feature an under-voltage lockout that prevents operation from an insufficient power supply and click-and-pop suppression that eliminates audible transients on startup and shutdown. The amplifiers include thermal overload and short-circuit protection.

Class D Speaker Amplifier

The MAX9791/MAX9792 integrate a filterless class D amplifier that offers much higher efficiency than class AB amplifiers. The high efficiency of a Class D amplifier is due to the switching operation of the output stage transistors. In a Class D amplifier, the output transistors act as current steering switches and consume negligible additional power. Any power loss associated with the Class D output stage is mostly due to the I²R loss of the MOSFET on-resistance and quiescent current overhead.

The theoretical best efficiency of a linear amplifier is 78%, however, that efficiency is only exhibited at peak output power. Under normal operating levels (typical music reproduction levels), efficiency falls below 45%, whereas the MAX9791/MAX9792 exhibit 67% efficiency under the same conditions (Figure 1).

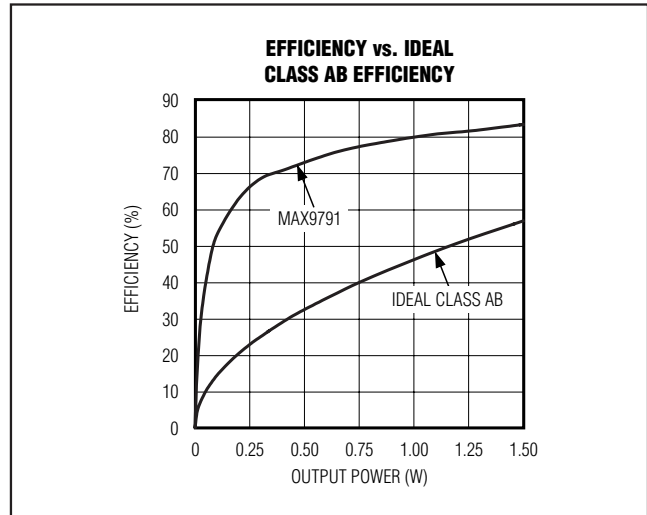

Figure 1. MAX9791 Efficiency vs. Class AB Efficiency

Ultra-Low EMI Filterless Output Stage

In traditional Class D amplifiers, the high dv/dt of the rising and falling edge transitions resulted in increased electromagnetic-interference (EMI) emissions, which required the use of external LC filters or shielding to meet EN55022B EMI regulation standards. Limiting the dv/dt normally results in decreased efficiency. Maxim's active emissions limiting circuitry actively limits the dv/dt of the rising and falling edge transitions, providing reduced EMI emissions while maintaining up to 83% efficiency.

Windows Vista-Compliant Class D Speaker Amplifiers with DirectDrive Headphone Amplifiers

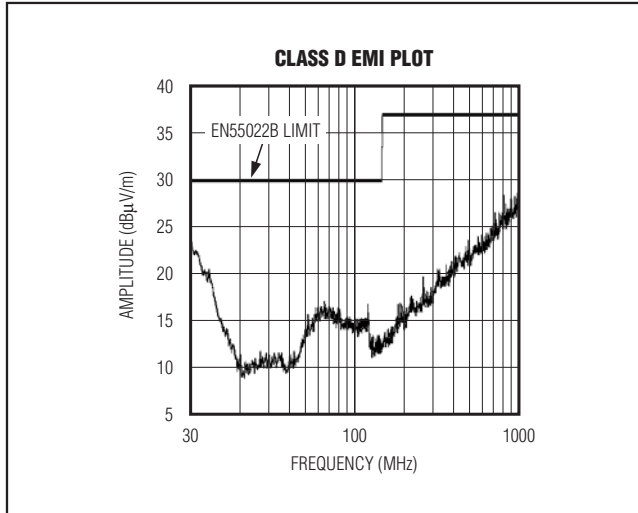

Figure 2. EMI with 30cm of Speaker Cable

In addition to active emission limiting, the MAX9791/MAX9792 feature spread-spectrum modulation that flattens the wideband spectral components. Proprietary techniques ensure that the cycle-to-cycle variation of the switching period does not degrade audio reproduction or efficiency (see the *Typical Operating Characteristics*). In spread-spectrum modulation mode, the switching frequency varies randomly by $\pm 15\text{kHz}$ around the center frequency (530kHz). The effect is to reduce the peak energy at harmonics of the switching frequency. Above 10MHz, the wideband spectrum looks like noise for EMI purposes (see Figure 2).

Speaker Current Limit

When the output current of the speaker amplifier exceeds the current limit (2A, typ) the MAX9791/MAX9792 disable the outputs for approximately 100 μs . At the end of 100 μs , the outputs are re-enabled. If the fault condition still exists, the MAX9791/MAX9792 continue to disable and re-enable the outputs until the fault condition is removed.

DirectDrive Headphone Amplifier

Traditional single-supply headphone amplifiers bias the outputs at a nominal DC voltage (typically half the supply). Large coupling capacitors are needed to block this DC bias from the headphone. Without these capacitors, a significant amount of DC current flows to the headphone, resulting in unnecessary power dissipation and possible damage to both headphone and headphone amplifier.

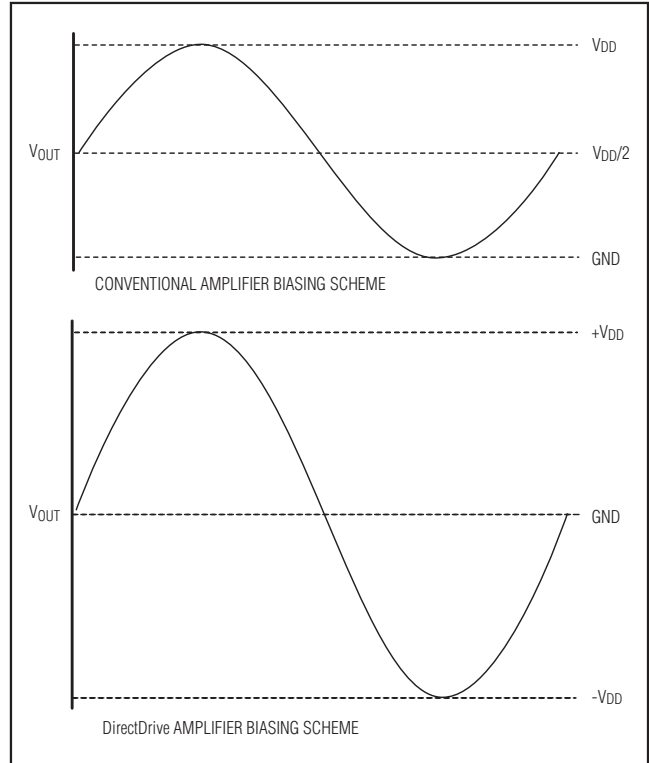

Figure 3. Traditional Amplifier Output vs. MAX9791/MAX9792 DirectDrive Output

Maxim's DirectDrive architecture uses a charge pump to create an internal negative supply voltage. This allows the headphone outputs of the MAX9791/MAX9792 to be biased at GND while operating from a single supply (Figure 3). Without a DC component, there is no need for the large DC-blocking capacitors. Instead of two large (220 μF , typ) capacitors, the MAX9791/MAX9792 charge pump requires two small 1 μF ceramic capacitors, conserving board space, reducing cost, and improving the frequency response of the headphone amplifier.

The MAX9791/MAX9792 feature a low-noise charge pump. The nominal switching frequency of 530kHz is well beyond the audio range, and thus does not interfere with audio signals. The switch drivers feature a controlled switching speed that minimizes noise generated by turn-on and turn-off transients. By limiting the switching speed of the charge pump, the di/dt noise caused by the parasitic trace inductance is minimized.

Windows Vista-Compliant Class D Speaker Amplifiers with DirectDrive Headphone Amplifiers

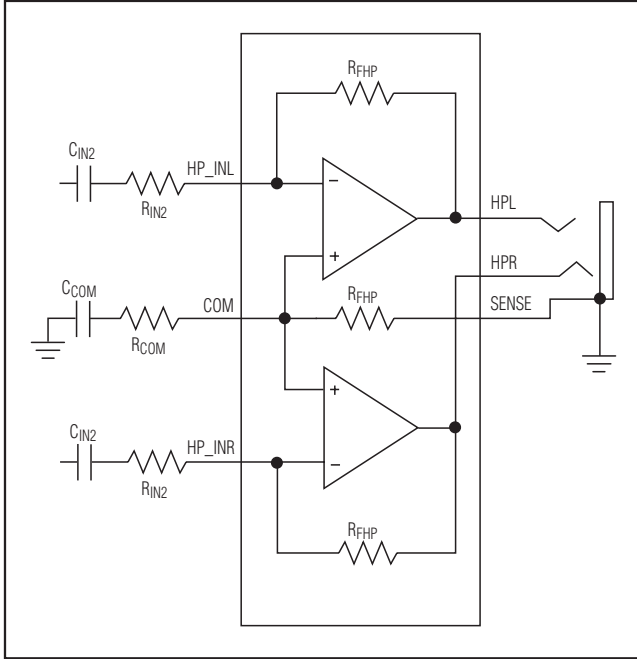

Figure 4. Connecting COM for Ground Sense

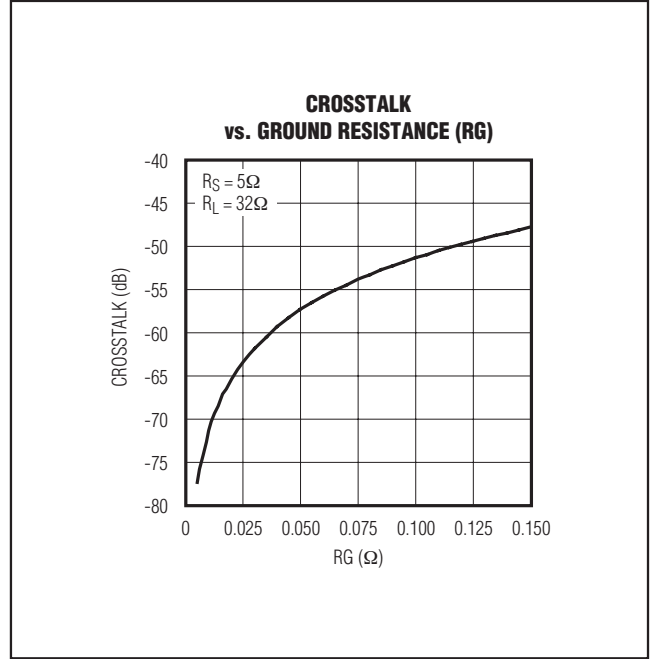

Figure 5. Crosstalk vs. Ground Resistance

Common-Mode Sense

Windows Vista-compliant platforms are restricted to only 115mΩ of ground return impedance. If the headphone jack ground is connected close to the audio device ground using a solid ground plane, the return path resistance can be quite low. However, it is often necessary to locate some jacks far from the audio device. The MAX9791/MAX9792 COM and SENSE inputs allow the headphone jack to be placed further away from the device without degrading crosstalk performance.

The MAX9791/MAX9792 SENSE and COM inputs sense and correct for the difference between the headphone return and device ground. When using common-mode sense, connect COM through a resistor to GND of the device (Figure 4). For optimum common-mode rejection, use the same value resistors for R_{IN2} and R_{COM}. To improve AC CMRR, add a capacitor equal to C_{IN2} between GND and R_{COM}.

Configuring SENSE and COM in this way improves system crosstalk performance by reducing the negative effects of the headphone jack ground return resistance.

$$\text{Crosstalk in dB} = 20 \log \left(\frac{R_G}{R_L + R_S} \right)$$

The headphone amplifier output impedance, trace resistance, and contact resistance of the jack are grouped together to represent the source resistance, R_S. The resistance between the load and the sleeve, the sleeve contact resistance, and the system ground return resistance are grouped together to represent the ground resistance, R_G.

Assuming a typical source resistance of 5Ω, the ground return impedance would need to be limited to 115mΩ to meet Windows Vista’s crosstalk specification of 50dB (Figure 5). This is further complicated by the fact that the impedance of the sleeve connection in the 3.5mm stereo jack can make up 30mΩ–90mΩ alone.

The MAX9791/MAX9792 COM and SENSE inputs reduce crosstalk performance by eliminating effects of 28.5mΩ of ground return path resistance. If ground sensing is not required, connect COM directly to GND and leave SENSE unconnected (Figure 6).

Wake-on-Beep

The MAX9791/MAX9792 beep-detection circuit wakes up the device (speaker and headphone amplifiers) once a qualified beep signal is detected at BEEP and the LDO is enabled. The amplifier wake command from the beep-detection circuit overrides the logic signal applied at HP_EN and SPKR_EN.

Windows Vista-Compliant Class D Speaker Amplifiers with DirectDrive Headphone Amplifiers

A qualified BEEP signal consists of a 3.3V typical, 215Hz minimum signal that is present at BEEP for four consecutive cycles. Once the first rising edge transition is detected at BEEP, the beep circuit wakes up and begins counting the beep cycles. Once four consecutive cycles of a qualified beep signal are counted, the device (speaker and headphone amplifiers) enables within 400µs. If the first rising edge is not followed by three consecutive rising edges within 16ms, the device remains shutdown (i.e., glitch protection).

The device (speaker and headphone amplifiers) returns to its programmed logic state once 246ms has elapsed from the time the last rising edge was detected. This 246ms amplifier hold time ensures complete beep profiles are passed to the amplifier outputs (Figure 7). Ground BEEP when the wake-on-beep feature is not used. Do not leave BEEP unconnected.

Low-Dropout Linear Regulator

The LDO regulator can be used to provide a clean power supply to a CODEC or other circuitry. The LDO can be enabled independently of the audio amplifiers. Set LDO_EN = AVDD to enable the LDO or set LDO_EN = GND to disable the LDO. The LDO can provide up to 120mA of continuous current.

Speaker and Headphone Amplifier Enable

The MAX9791/MAX9792 feature control inputs for the independent enabling of the speaker and headphone amplifiers, allowing both to be active simultaneously if required. Driving SPKR_EN high disables the speaker amplifiers. Driving HP_EN low independently disables the headphone amplifiers. For applications that require only one of the amplifiers to be on at a given

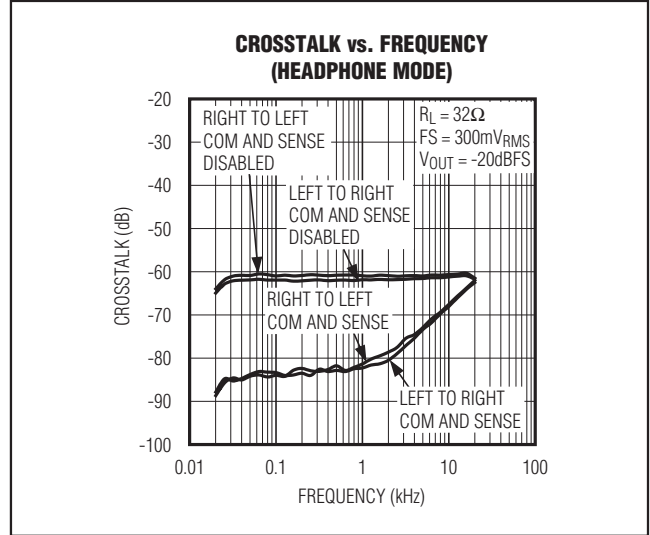

Figure 6. MAX9791/MAX9792 COM and SENSE Inputs Reduce Crosstalk

time, connect $\overline{\text{SPKR_EN}}$ and HP_EN together, allowing a single logic voltage to enable either the speaker or the headphone amplifier as shown in Figure 8.

Shutdown

The MAX9791/MAX9792 feature a low-power shutdown mode, drawing 3.3µA of supply current. By disabling the speaker, headphone amplifiers, and the LDO, the MAX9791/MAX9792 enter low-power shutdown mode. Set $\overline{\text{SPKR_EN}}$ to AVDD and HP_EN and LDO_EN to GND to disable the speaker amplifiers, headphone amplifiers, and LDO, respectively.

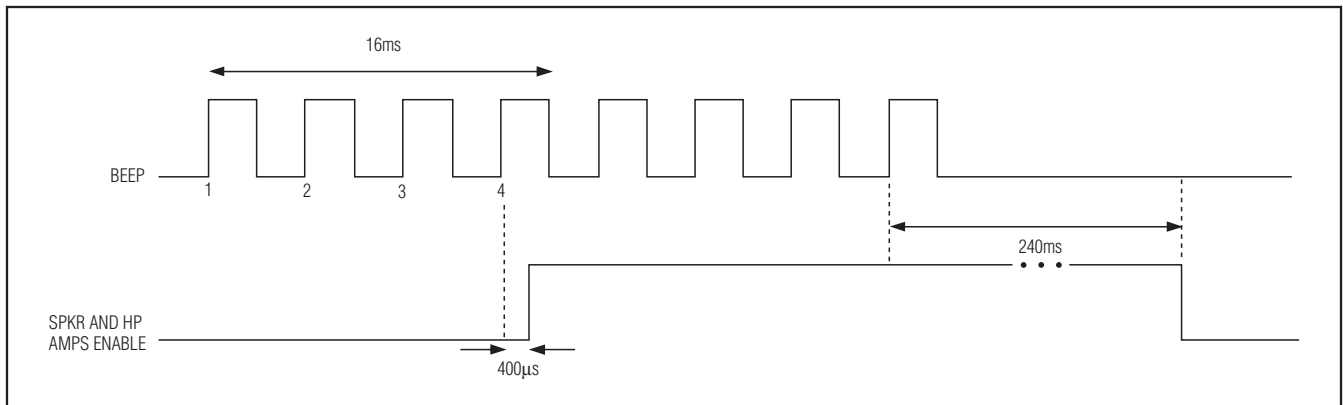

Figure 7. Qualified BEEP Signal Timing

Windows Vista-Compliant Class D Speaker Amplifiers with DirectDrive Headphone Amplifiers

MAX9791/MAX9792

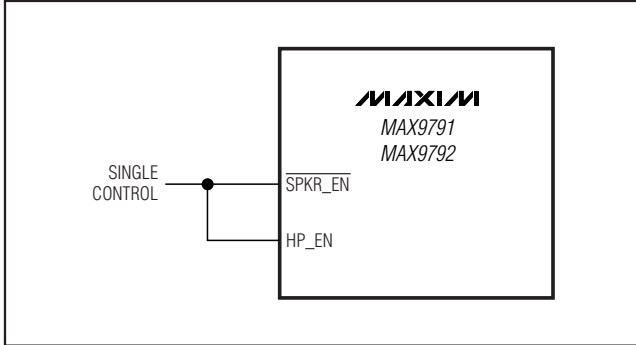

Figure 8. Enabling Either the Speaker or Headphone Amplifier with a Single Control Pin

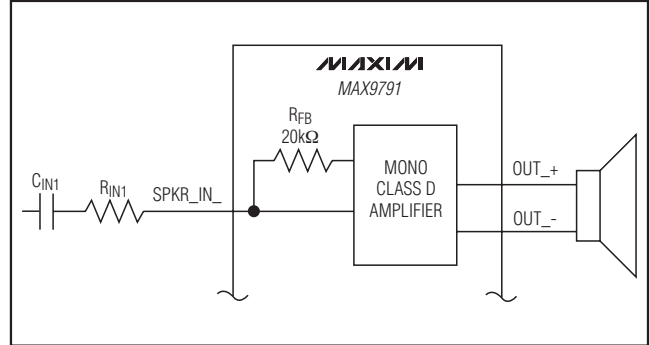

Figure 9. Setting Speaker Amplifier Gain

Click-and-Pop Suppression

The MAX9791/MAX9792 feature a common-mode bias voltage of 0V. A 0V BIAS allows the MAX9791/MAX9792 to quickly turn on/off with no resulting clicks and pops. With the HDA CODEC outputs biased and the MAX9791/MAX9792 inputs sitting as 0V in shutdown and normal operation, the $R_{IN} \times C_{IN}$ time constant is eliminated.

Speaker Amplifier

The MAX9791/MAX9792 speaker amplifiers feature Maxim’s comprehensive, industry leading click-and-pop suppression. During startup and shutdown, the click-and-pop suppression circuitry eliminates any audible transient sources internal to the device.

Headphone Amplifier

In conventional single-supply headphone amplifiers, the output-coupling capacitor is a major contributor of audible clicks and pops. Upon startup, the amplifier charges the coupling capacitor to its bias voltage, typically $V_{DD}/2$. During shutdown, the capacitor is discharged to GND; a DC shift across the capacitor results, which in turn appears as an audible transient at the speaker. Because the MAX9791/MAX9792 do not require output-coupling capacitors, no audible transient occurs.

The MAX9791/MAX9792 headphone amplifiers feature extensive click-and-pop suppression that eliminates any audible transient sources internal to the device.

Applications Information

Filterless Class D Operation

Traditional Class D amplifiers require an output filter to recover the audio signal from the amplifier’s output. The filters add cost and size and can decrease efficiency and THD+N performance. The traditional PWM scheme uses large differential output swings ($2 \times PV_{DD}$ peak-to-peak) causing large ripple currents. Any parasitic resistance in the filter components results in a loss of power, lowering the efficiency.

The MAX9791/MAX9792 do not require an output filter. The devices rely on the inherent inductance of the speaker coil and the natural filtering of both the speaker and the human ear to recover the audio component of the square-wave output. Eliminating the output filter results in a smaller, less costly, and more efficient solution.

Because the frequency of the MAX9791/MAX9792 output is well beyond the bandwidth of most speakers, voice coil movement due to the square-wave frequency is very small. For optimum results, use a speaker with a series inductance $> 10\mu\text{H}$. Typical 8Ω speakers exhibit series inductances in the $20\mu\text{H}$ to $100\mu\text{H}$ range.

Windows Vista-Compliant Class D Speaker Amplifiers with DirectDrive Headphone Amplifiers

Setting Speaker Amplifier Gain

External input resistors in conjunction with the internal feedback resistors (R_{FSPKR}) set the speaker amplifier gain of the MAX9791/MAX9792. Set gain by using resistor R_{IN1} as follows (Figure 9):

$$A_{VSPKR} = -4 \left(\frac{20k\Omega}{R_{IN1}} \right) V/V$$

where A_{VSPKR} is the desired voltage gain. An R_{IN1} of $20k\Omega$ yields a gain of $4V/V$, or $12dB$.

Component Selection

Optional Ferrite Bead Filter

In applications where speaker leads exceed $15cm$, use a filter constructed from a ferrite bead and a capacitor to ground (Figure 10) to provide additional EMI suppression. Use a ferrite bead with low DC resistance, high frequency ($> 1.2MHz$) impedance of 100Ω to 600Ω , and rated for at least $1A$. The capacitor value varies based on the ferrite bead chosen and the actual speaker lead length. Select the capacitor value based on EMI performance.

Output Power (Headphone Amplifier)

The headphone amplifiers are specified for the worst-case scenario when both inputs are in phase. Under this condition, the drivers simultaneously draw current from the charge pump, leading to a slight loss in headroom of CPVSS. In typical stereo audio applications, the left and right signals have differences in both magnitude and phase, subsequently leading to an increase in the maximum attainable output power. Figure 11 shows the two extreme cases for in and out of phase. In most cases, the available power lies between these extremes.

Headphone Amplifier Gain

Gain-Setting Resistors

External input resistors in conjunction with the internal feedback resistors (R_{FHP}) set the headphone amplifier gain of the MAX9791/MAX9792. Set gain by using resistor R_{IN2} (Figure 4) as follows:

$$A_{VHP} = - \left(\frac{40.2k\Omega}{R_{IN2}} \right) V/V$$

where A_{VHP} is the desired voltage gain. An R_{IN2} of $40.2k\Omega$ yields a gain of $1V/V$, or $0dB$.

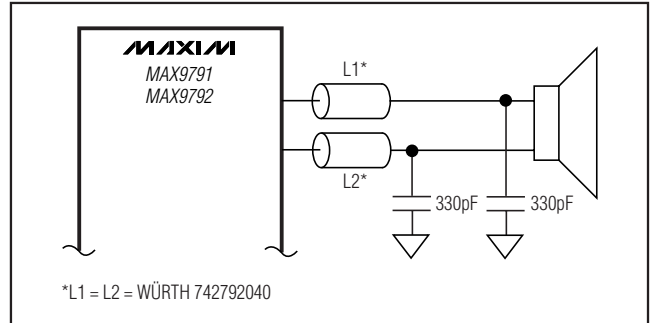

Figure 10. Optional Ferrite Bead Filter

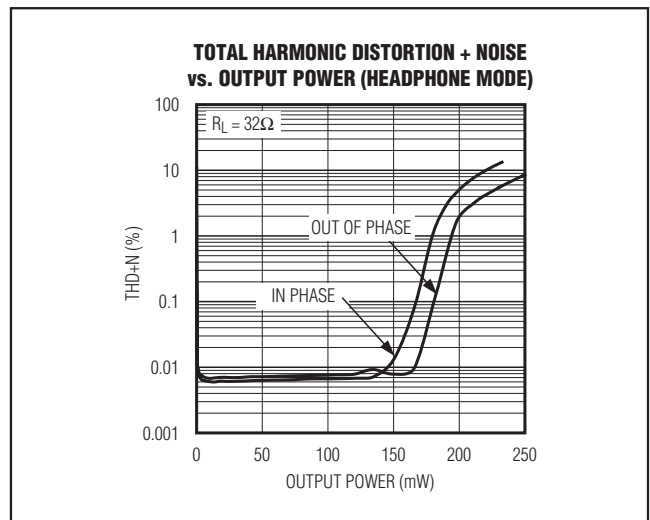

Figure 11. Output Power vs. Supply Voltage with Inputs In/Out of Phase; 32Ω Load Conditions and $3.5dB$ Gain

Power Supplies

The MAX9791/MAX9792 speaker amplifiers are powered from PVDD with a range from $2.7V$ to $5.5V$. The headphone amplifiers are powered from HPVDD and CPVSS. HPVDD is the positive supply of the headphone amplifiers and charge pump ranging from $2.7V$ to $5.5V$. CPVSS is the negative supply of the headphone amplifiers. The charge pump inverts the voltage at HPVDD, and the resulting voltage appears at CPVSS. AVDD powers the LDO and the remainder of the device. AVDD and PVDD must be tied together. If LDO is enabled, set AVDD and PVDD as specified in the Line Regulation row of the *Electrical Characteristics* table.

Windows Vista-Compliant Class D Speaker Amplifiers with DirectDrive Headphone Amplifiers

MAX9791/MAX9792

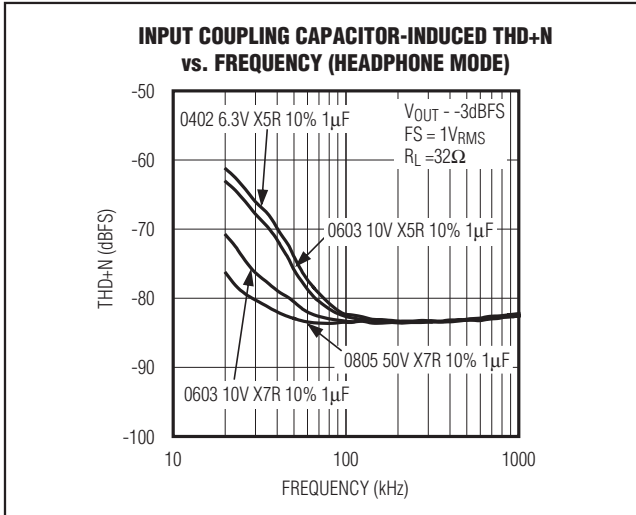

Figure 12. Input Coupling Capacitor-Induced THD+N vs. Frequency

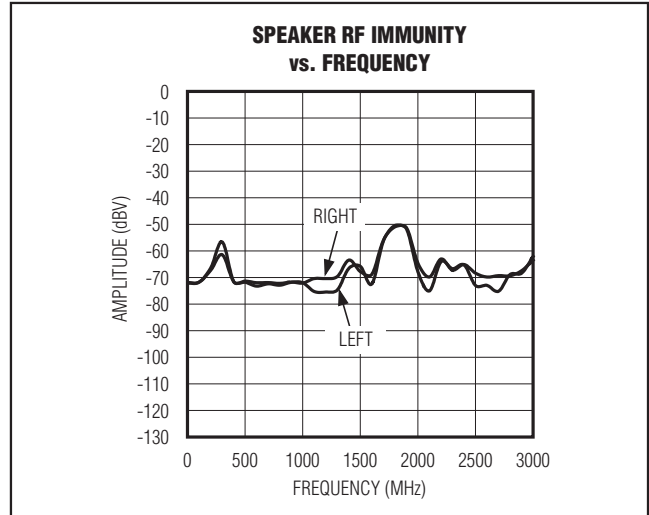

Figure 13. Speaker RF Immunity

Component Selection

Speaker Amplifier Power-Supply Input (PVDD)

PVDD powers the speaker amplifiers. PVDD ranges from 2.7V to 5.5V. AVDD and PVDD must be tied together. If LDO is enabled, set AVDD and PVDD as specified in the Line Regulation row of the *Electrical Characteristics* table. Bypass PVDD with a 0.1µF capacitor to PGND. Apply additional bulk capacitance at the device if long input traces between PVDD and the power source are used.

Headphone Amplifier Power-Supply Input (HPVDD and CPVSS)

The headphone amplifiers are powered from HPVDD and CPVSS. HPVDD is the positive supply of the headphone amplifiers and ranges from 2.7V to 5.5V. Bypass HPVDD with a 10µF capacitor to PGND. CPVSS is the negative supply of the headphone amplifiers. Bypass CPVSS with a 1µF capacitor to PGND. The charge pump inverts the voltage at HPVDD, and the resulting voltage appears at CPVSS. A 1µF capacitor should be connected between C1N and C1P.

Positive Power Supply and LDO Input (AVDD)

The internal LDO and the remainder of the device are powered by AVDD. AVDD ranges from 2.7V to 5.5V. AVDD and PVDD must be tied together. If LDO is enabled, set AVDD and PVDD as specified in LDO line regulation. Bypass AVDD with a 0.1µF capacitor to GND and two 1µF capacitors to GND. Note additional bulk capacitance is required at the device if long input traces between AVDD and the power source are used.

Input Filtering

The input capacitor ($C_{IN_}$), in conjunction with the amplifier input resistance ($R_{IN_}$), forms a highpass filter that removes the DC bias from the incoming signal. The AC-coupling capacitor allows the amplifier to bias the signal to an optimum DC level. Assuming zero source impedance, the -3dB point of the highpass filter is given by:

$$f_{-3dB} = \frac{1}{2\pi R_{IN_} C_{IN_}}$$

$R_{IN_}$ is the amplifier's external input resistance value. Choose $C_{IN_}$ such that f_{-3dB} is well below the lowest frequency of interest. Setting f_{-3dB} too high affects the amplifier's low frequency response. Use capacitors with adequately low-voltage coefficients (see Figure 12). Capacitors with higher voltage coefficients, such as ceramics, result in increased distortion at low frequencies.

Charge-Pump Capacitor Selection

Use capacitors with an ESR less than 100mΩ for optimum performance. Low ESR ceramic capacitors minimize the output resistance of the charge pump. For best performance over the extended temperature range, select capacitors with an X7R dielectric.

Flying Capacitor (C1)

The value of the flying capacitor (C1) affects the load regulation and output resistance of the charge pump. A C1 value that is too small degrades the device's ability to provide sufficient current drive, which leads to a loss of output voltage. Connect a 1µF capacitor between C1P and C1N.

Windows Vista-Compliant Class D Speaker Amplifiers with DirectDrive Headphone Amplifiers

Charge-Pump Output Capacitor (C2)

Connect a 1 μ F capacitor between CPVSS and PGND.

LDO Output Capacitor (CLDO)

Connect 2 x 1 μ F capacitors between LDO_OUT and GND for 4.75V and 3.3V LDO options (MAX979_A and MAX979_B, respectively). Connect two parallel 2 μ F capacitors between LDO_OUT and GND for the 1.8V LDO option (MAX979_C).

Layout and Grounding

Proper layout and grounding are essential for optimum performance. Use large traces for the power-supply inputs and amplifier outputs to minimize losses due to parasitic trace resistance, as well as route heat away from the device. Good grounding improves audio performance, minimizes crosstalk between channels, and prevents switching noise from coupling into the audio signal. Connect PGND and GND together at a single point on the PCB. Route PGND and all traces that carry switching transients away from GND, and the traces and components in the audio signal path.

Connect C2 to the PGND plane. Place the charge-pump capacitors (C1, C2) as close as possible to the device. Bypass PVDD with a 0.1 μ F capacitor to PGND. Place the bypass capacitors as close as possible to the device.

The MAX9791/MAX9792 is inherently designed for excellent RF immunity. For best performance, add ground fills around all signal traces on top or bottom PCB planes.

Use large, low-resistance output traces. As load impedance decreases, the current drawn from the device outputs increase. At higher current, the resistance of the output traces decrease the power delivered to the load. For example, if 2W is delivered from the speaker output to a 4 Ω load through a 100m Ω trace, 49mW is wasted in the trace. If power is delivered through a 10m Ω trace, only 5mW is wasted in the trace. Large output, supply, and GND traces also improve the power dissipation of the device.

The MAX9791/MAX9792 thin QFN package features an exposed thermal pad on its underside. This pad lowers the package's thermal resistance by providing a direct heat conduction path from the die to the printed circuit board. Connect the exposed thermal pad to GND by using a large pad and multiple vias to the GND plane.

Chip Information

PROCESS: BiCMOS

Windows Vista-Compliant Class D Speaker Amplifiers with DirectDrive Headphone Amplifiers

Pin Configurations

MAX9791/MAX9792

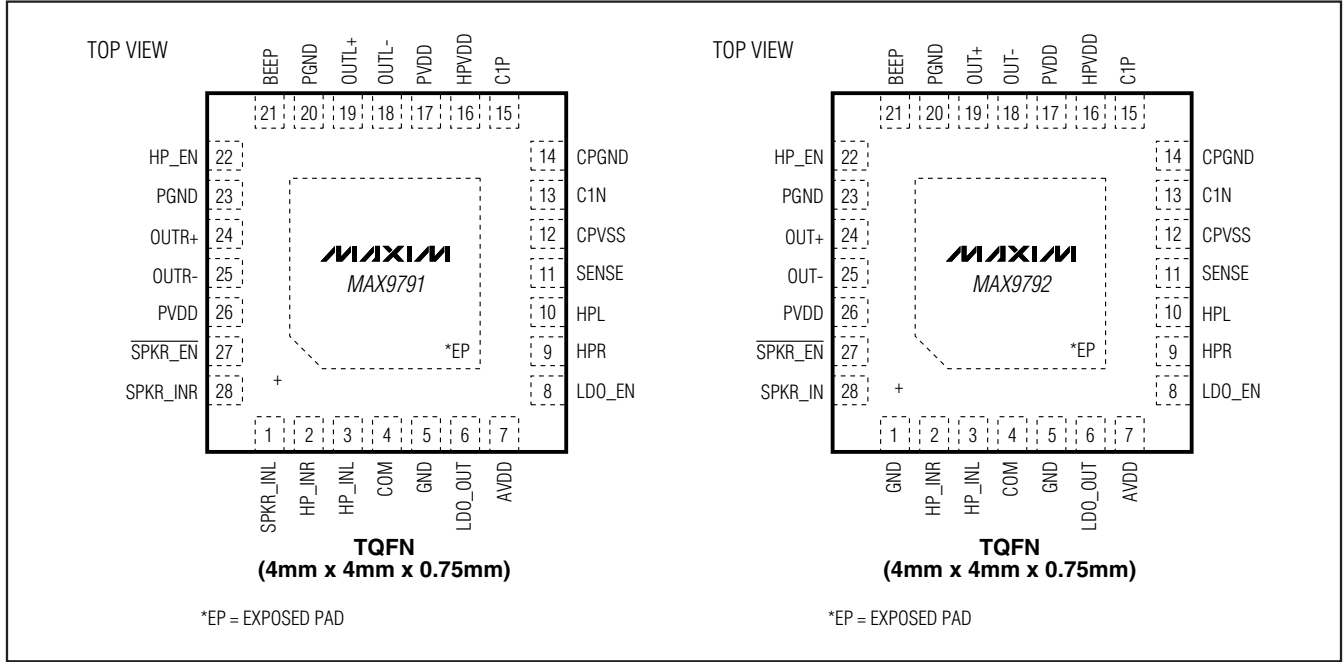

Simplified Block Diagrams (continued)

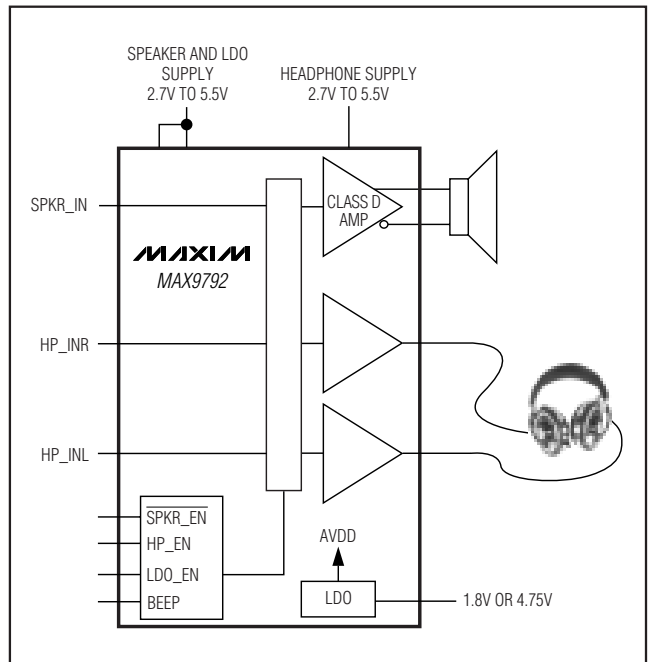

Windows Vista-Compliant Class D Speaker Amplifiers with DirectDrive Headphone Amplifiers

MAX9791A/MAX9791B Block Diagram

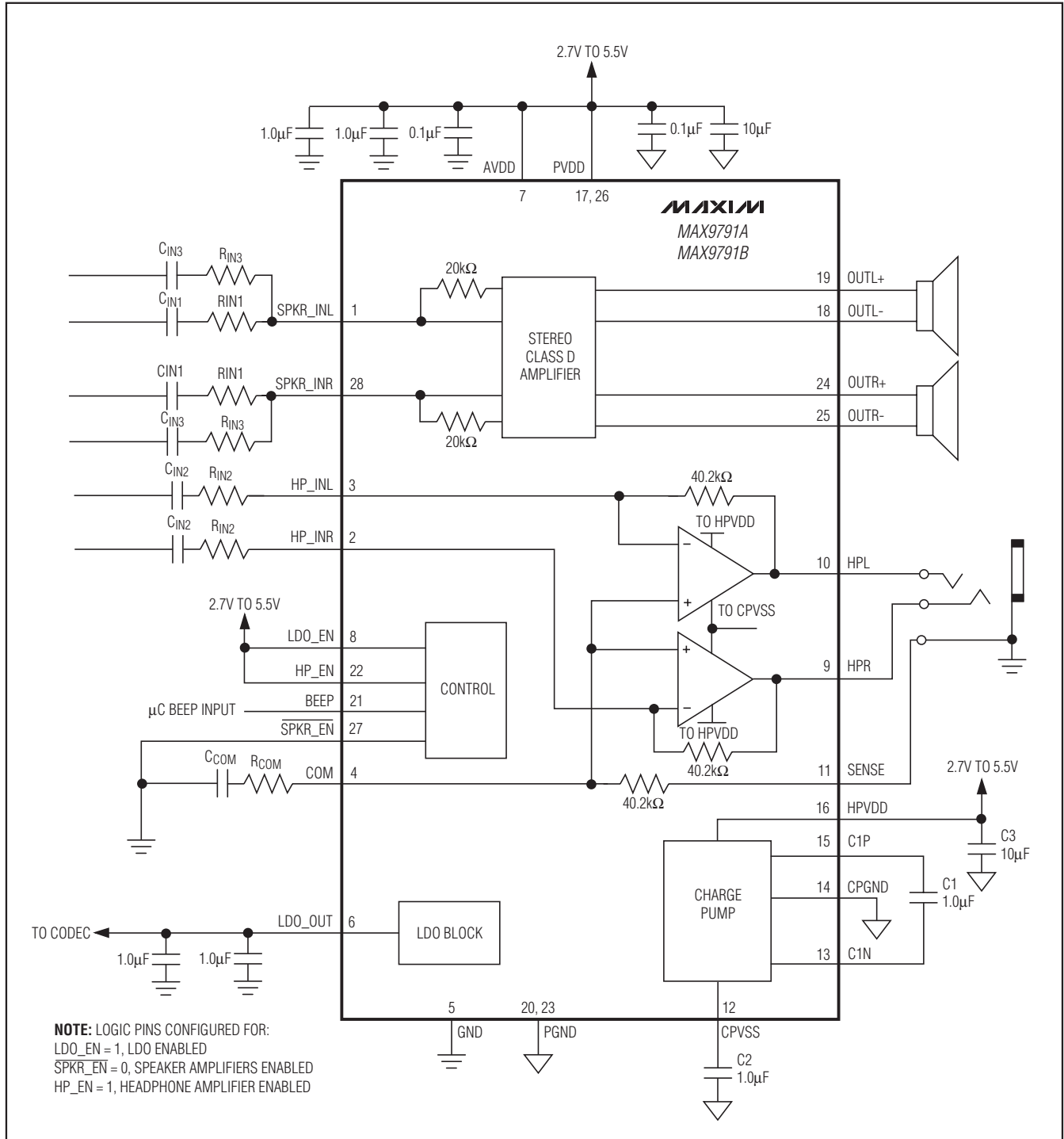

Windows Vista-Compliant Class D Speaker Amplifiers with DirectDrive Headphone Amplifiers

MAX9791C Block Diagram

MAX9791/MAX9792

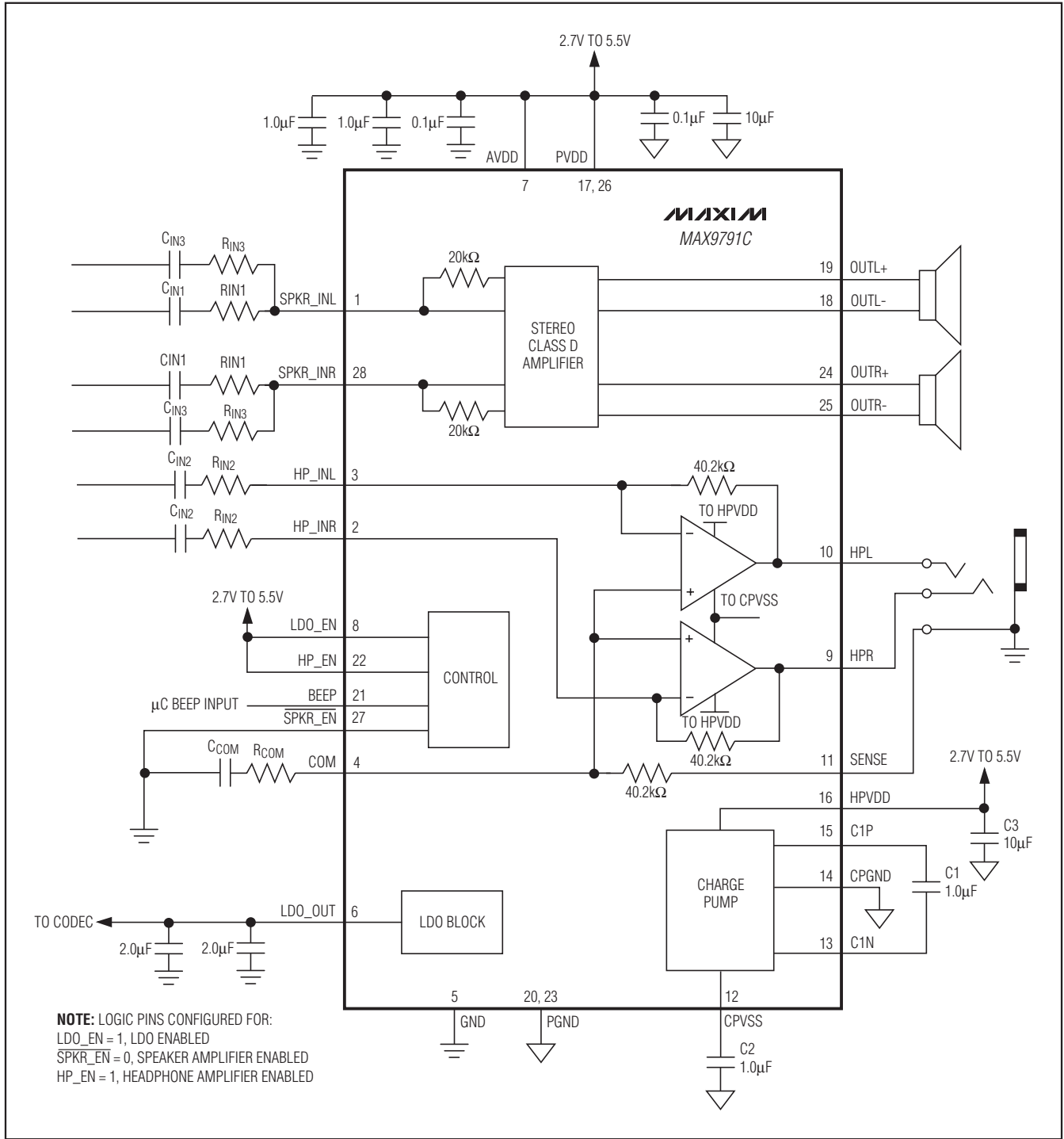

Windows Vista-Compliant Class D Speaker Amplifiers with DirectDrive Headphone Amplifiers

MAX9792A Block Diagram

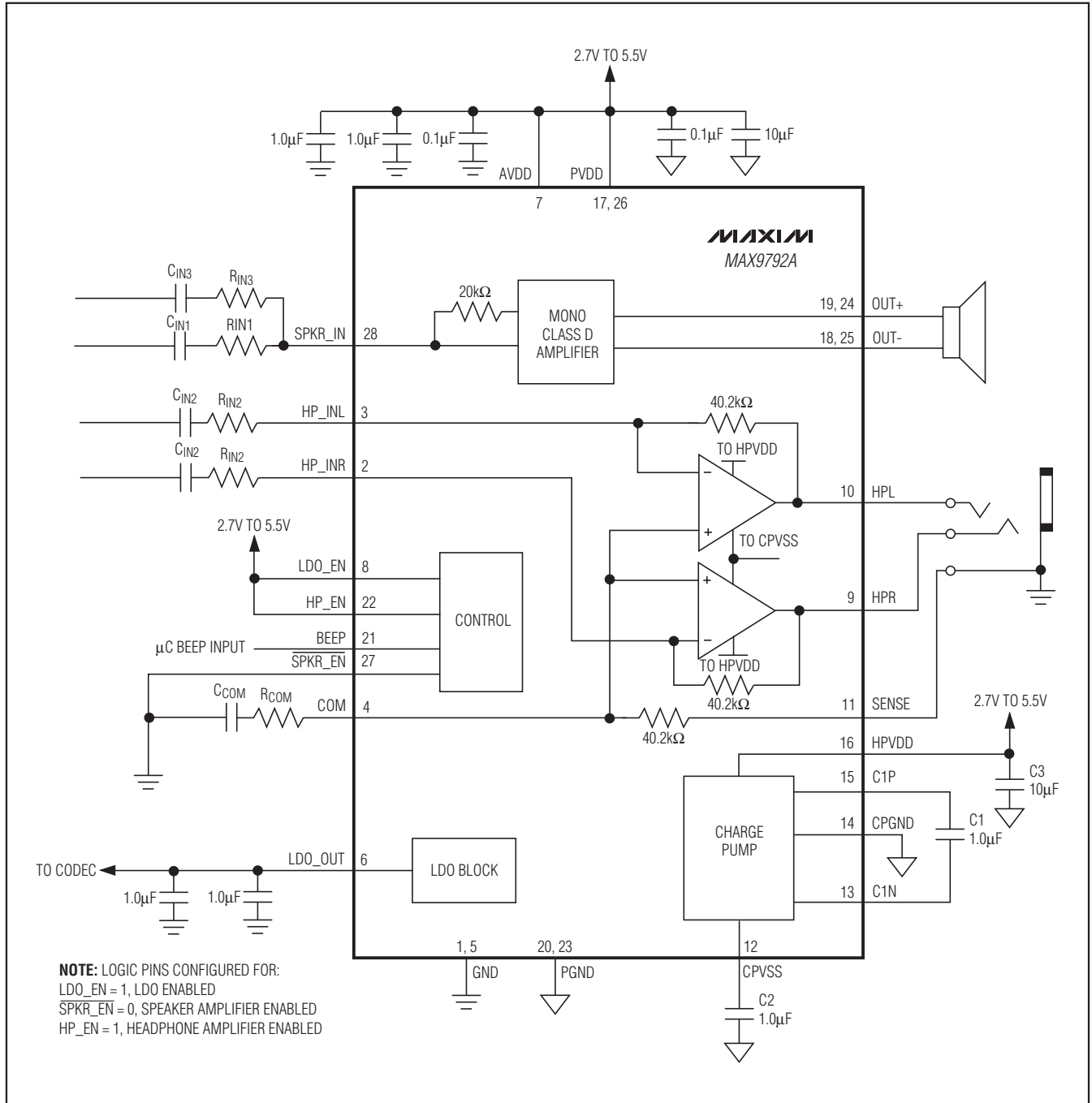

Windows Vista-Compliant Class D Speaker Amplifiers with DirectDrive Headphone Amplifiers

MAX9792C Block Diagram

MAX9791/MAX9792

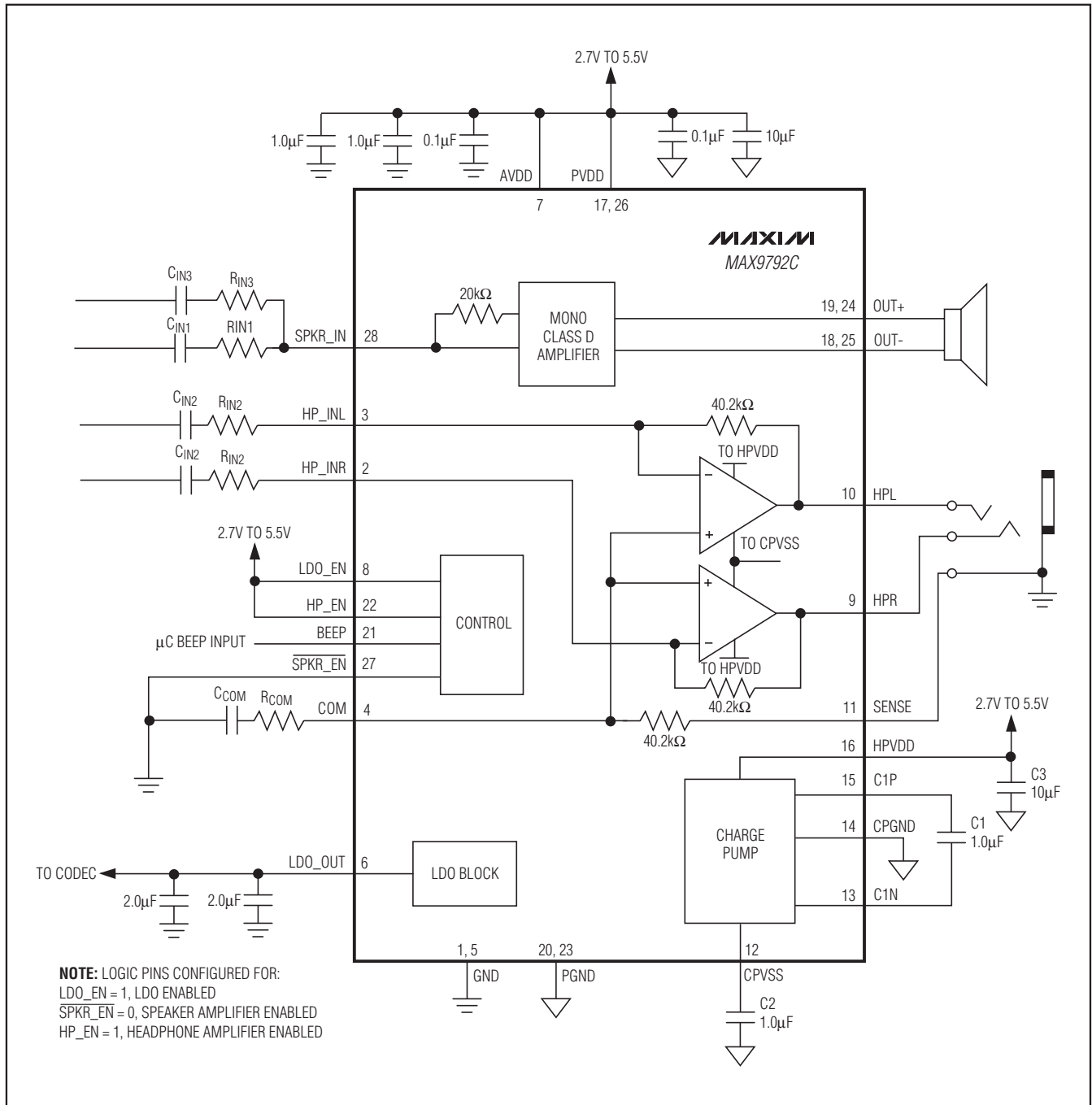

Windows Vista-Compliant Class D Speaker Amplifiers with DirectDrive Headphone Amplifiers

Package Information

For the latest package outline information and land patterns, go to www.maxim-ic.com/packages. Note that a "+", "#", or "-" in the package code indicates RoHS status only. Package drawings may show a different suffix character, but the drawing pertains to the package regardless of RoHS status.

PACKAGE TYPE	PACKAGE CODE	OUTLINE NO.	LAND PATTERN NO.
28 TQFN-EP	T2844-1	21-0139	90-0068

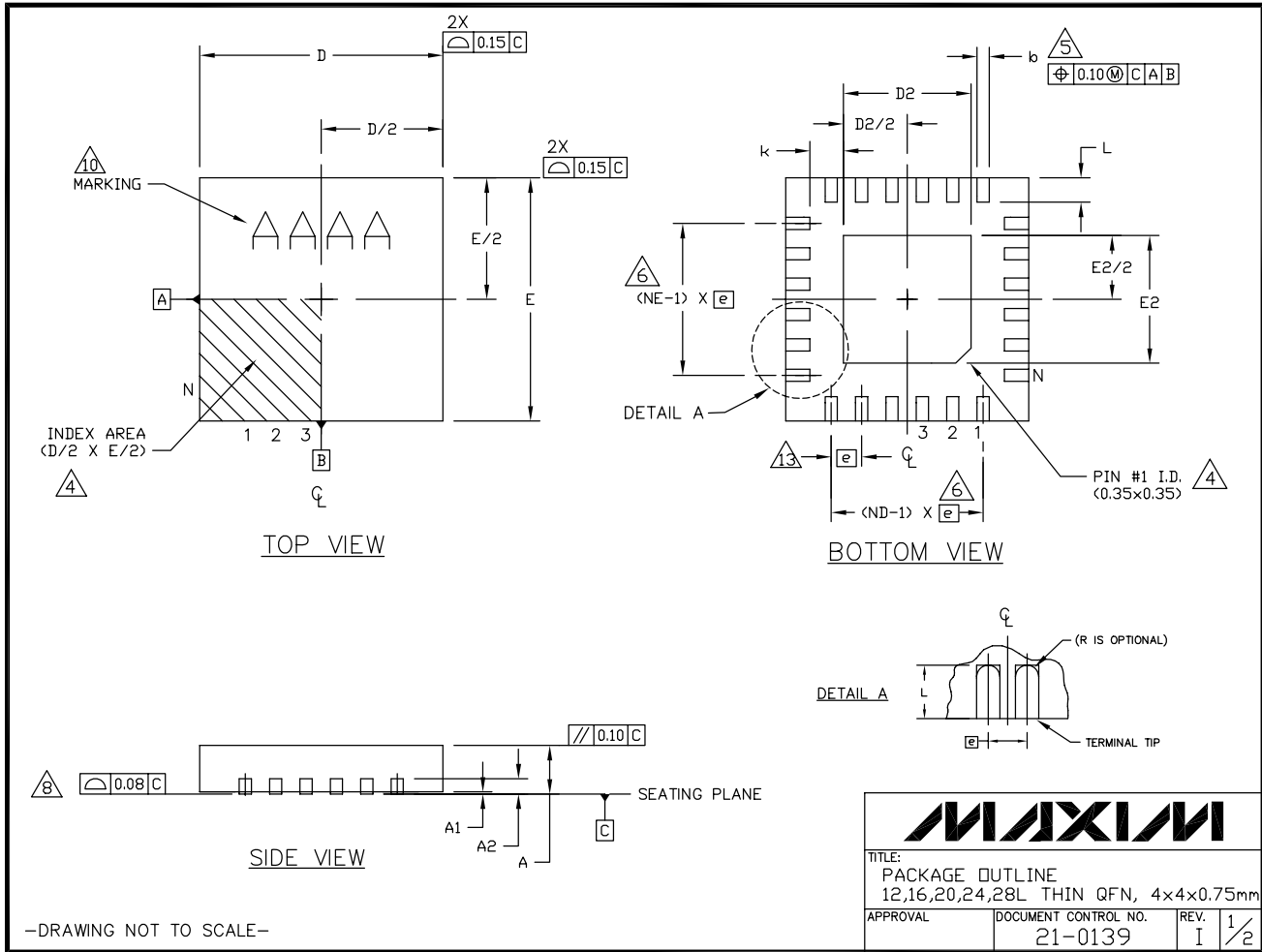

Windows Vista-Compliant Class D Speaker Amplifiers with DirectDrive Headphone Amplifiers

Package Information (continued)

For the latest package outline information and land patterns, go to www.maxim-ic.com/packages. Note that a "+", "#", or "-" in the package code indicates RoHS status only. Package drawings may show a different suffix character, but the drawing pertains to the package regardless of RoHS status.

MAX9791/MAX9792

COMMON DIMENSIONS															
PKG REF.	12L 4x4			16L 4x4			20L 4x4			24L 4x4			28L 4x4		
	MIN.	NDM.	MAX.	MIN.	NDM.	MAX.	MIN.	NDM.	MAX.	MIN.	NDM.	MAX.	MIN.	NDM.	MAX.
A	0.70	0.75	0.80	0.70	0.75	0.80	0.70	0.75	0.80	0.70	0.75	0.80	0.70	0.75	0.80
A1	0.0	0.02	0.05	0.0	0.02	0.05	0.0	0.02	0.05	0.0	0.02	0.05	0.0	0.02	0.05
A2	0.20 REF			0.20 REF			0.20 REF			0.20 REF			0.20 REF		
b	0.25	0.30	0.35	0.25	0.30	0.35	0.20	0.25	0.30	0.18	0.23	0.30	0.15	0.20	0.25
D	3.90	4.00	4.10	3.90	4.00	4.10	3.90	4.00	4.10	3.90	4.00	4.10	3.90	4.00	4.10
E	3.90	4.00	4.10	3.90	4.00	4.10	3.90	4.00	4.10	3.90	4.00	4.10	3.90	4.00	4.10
e	0.80 BSC.			0.65 BSC.			0.50 BSC.			0.50 BSC.			0.40 BSC.		
k	0.25	-	-	0.25	-	-	0.25	-	-	0.25	-	-	0.25	-	-
L	0.45	0.55	0.65	0.45	0.55	0.65	0.45	0.55	0.65	0.30	0.40	0.50	0.30	0.40	0.50
N	12			16			20			24			28		
ND	3			4			5			6			7		
NE	3			4			5			6			7		
Jedec Vpr	WGG8			WGGC			WGGD-1			WGGD-2			WGGE		

EXPOSED PAD VARIATIONS						
PKG. CODES	D2			E2		
	MIN.	NDM.	MAX.	MIN.	NDM.	MAX.
T1244-3	1.95	2.10	2.25	1.95	2.10	2.25
T1244-4	1.95	2.10	2.25	1.95	2.10	2.25
T1644-3	1.95	2.10	2.25	1.95	2.10	2.25
T1644-4	1.95	2.10	2.25	1.95	2.10	2.25
T2044-2	1.95	2.10	2.25	1.95	2.10	2.25
T2044-3	1.95	2.10	2.25	1.95	2.10	2.25
T2444-2	1.95	2.10	2.25	1.95	2.10	2.25
T2444-3	2.45	2.60	2.63	2.45	2.60	2.63
T2444-4	2.45	2.60	2.63	2.45	2.60	2.63
T2444N-4	2.45	2.60	2.63	2.45	2.60	2.63
T2444M-1	2.45	2.60	2.63	2.45	2.60	2.63
T2844-1	2.50	2.60	2.70	2.50	2.60	2.70

NOTES:

- DIMENSIONING & TOLERANCING CONFORM TO ASME Y14.5M-1994.
- ALL DIMENSIONS ARE IN MILLIMETERS. ANGLES ARE IN DEGREES.
- N IS THE TOTAL NUMBER OF TERMINALS.
- THE TERMINAL #1 IDENTIFIER AND TERMINAL NUMBERING CONVENTION SHALL CONFORM TO JESD 95-1 SPP-012. DETAILS OF TERMINAL #1 IDENTIFIER ARE OPTIONAL, BUT MUST BE LOCATED WITHIN THE ZONE INDICATED. THE TERMINAL #1 IDENTIFIER MAY BE EITHER A MOLD OR MARKED FEATURE.
- DIMENSION b APPLIES TO METALLIZED TERMINAL AND IS MEASURED BETWEEN 0.25mm AND 0.30mm FROM TERMINAL TIP.
- ND AND NE REFER TO THE NUMBER OF TERMINALS ON EACH D AND E SIDE RESPECTIVELY.
- DEPOPULATION IS POSSIBLE IN A SYMMETRICAL FASHION.
- COPLANARITY APPLIES TO THE EXPOSED HEAT SINK SLUG AS WELL AS THE TERMINALS.
- DRAWING CONFORMS TO JEDEC MQ220, EXCEPT FOR T2444-3, T2444-4 AND T2844-1.
- MARKING IS FOR PACKAGE ORIENTATION REFERENCE ONLY.
- COPLANARITY SHALL NOT EXCEED 0.08mm.
- WARPAGE SHALL NOT EXCEED 0.10mm.
- LEAD CENTERLINES TO BE AT TRUE POSITION AS DEFINED BY BASIC DIMENSION 'e', ±0.05.
- NUMBER OF LEADS SHOWN ARE FOR REFERENCE ONLY.
- ALL DIMENSIONS ARE THE SAME FOR LEADED (-) & PbFREE (+) PACKAGE CODES.

-DRAWING NOT TO SCALE-

TITLE: PACKAGE OUTLINE 12,16,20,24,28L THIN QFN, 4x4x0.75mm		
APPROVAL	DOCUMENT CONTROL NO. 21-0139	REV. I 2/2

Windows Vista-Compliant Class D Speaker Amplifiers with DirectDrive Headphone Amplifiers

Revision History

REVISION NUMBER	REVISION DATE	DESCRIPTION	PAGES CHANGED
0	11/08	Initial release	—
1	6/10	Adding MAX9791C/MAX9792C versions	1-7, 10, 13-16, 19, 21-30

Maxim cannot assume responsibility for use of any circuitry other than circuitry entirely embodied in a Maxim product. No circuit patent licenses are implied. Maxim reserves the right to change the circuitry and specifications without notice at any time.

34 _____ **Maxim Integrated Products, 120 San Gabriel Drive, Sunnyvale, CA 94086 408-737-7600**

Mouser Electronics

Authorized Distributor

Click to View Pricing, Inventory, Delivery & Lifecycle Information:

Maxim Integrated:

[MAX9791AETI+](#) [MAX9791AETI+T](#) [MAX9791BETI+](#) [MAX9791BETI+T](#) [MAX9792AETI+](#) [MAX9792AETI+T](#)
[MAX9792CETI+](#) [MAX9792CETI+T](#) [MAX9791CETI+](#) [MAX9791CETI+T](#)