

# E3Z-L

## Small 2.5-mm-diameter Spot Ideal for Detecting Small Workpieces

- Tiny workpieces as little as 0.1 mm in diameter can be detected with the 2.5-mm-dia. spot.
- The narrow beam enables sensing from small slots or holes.
- The small spot of light enables visual checking of sensing spot position.
- IP67 degree of protection, mutual interference prevention, and EN standard compliance.





 Be sure to read *Safety Precautions* on page 4.

## Ordering Information

### Sensors

 Infrared light

Sensing method	Appearance	Connection method	Sensing distance	Model	
				NPN output	PNP output
Narrow-beam reflective		Pre-wired	 90±30 mm	E3Z-L61 *1 *2	E3Z-L81 *1 *2
		Connector (M8, 4pins)		E3Z-L66	E3Z-L86

\*1. M12 Standard Pre-wired Connector Models are also available.  
When ordering, add "-M1J 0.3M" to the end of the model number (e.g., E3Z-L61-M1J 0.3M).  
The cable is 0.3 m long.

\*2. M12 Pre-wired Smartclick Connector Models are also available.  
When ordering, add "-M1TJ 0.3M" to the end of the model number (e.g., E3Z-L61-M1TJ 0.3M).  
The cable is 0.3 m long.

### Accessories (Order Separately)

[Mounting Brackets](#)

[Sensor I/O Connectors](#)

## Ratings and Specifications

Sensing method		Narrow-beam reflective		
Item	Model	NPN output	E3Z-L61	E3Z-L66
		PNP output	E3Z-L81	E3Z-L86
Sensing distance		White paper (100 × 100 mm): 90±30 mm		
Spot diameter (typical)		2.5-mm dia. min. (at sensing distance of 90 mm)		
Minimum detectable object (typical)		0.1-mm dia. (copper wire)		
Differential travel (typical)		Refer to <i>Differential Travel vs. Sensing Distance</i> on page 2.		
Light source (wavelength)		Red LED (650 nm)		
Power supply voltage		12 to 24 VDC ±10%, ripple (p-p): 10% max.		
Current consumption		30 mA max.		
Control output		Load power supply voltage: 26.4 V max.; Load current: 100 mA max. Residual voltage: Load current of less than 10 mA: 1 V max. Load current of 10 to 100 mA: 2 V max. Open collector output (NPN or PNP depending on model) Light-ON/Dark-ON selectable		
Protection circuits		Power supply reverse polarity protection, Output short-circuit protection, Mutual interference prevention, Reverse output polarity protection		
Response time		Operate or reset: 1 ms max.		
Sensitivity adjustment		One-turn adjuster		
Ambient illumination (Receiver side)		Incandescent lamp: 3,000 lx max., Sunlight: 10,000 lx max.		
Ambient temperature range		Operating: -25 to 55°C, Storage: -40 to 70°C (with no icing or condensation)		
Ambient humidity range		Operating: 35 to 85%, Storage: 35 to 95% (with no condensation)		
Insulation resistance		20 MΩ min. at 500 VDC		
Dielectric strength		1,000 VAC 50/60 Hz for 1 min		
Vibration resistance		Destruction: 10 to 55 Hz, 1.5-mm double amplitude for 2 hours each in X, Y, and Z directions.		
Shock resistance		Destruction: 500m/s <sup>2</sup> 3 times each in the X, Y, and Z directions		
Degree of protection		IP67 (IEC 60529)		
Connection method		Pre-wired (standard length: 2 m and 0.5 m)	Connector (M8, 4 pins)	
Indicators		Operation indicator (orange), Stability indicator (green)		
Weight (packed state)		Pre-wired type, 2 m: Approx. 65 g	Approx. 20 g	
Material	Case	PBT (polybutylene terephthalate)		
	Lens	Modified polyarylate		
Accessories		Instruction manual (Mounting Brackets must be ordered separately.)		

## Engineering Data

### Operating Range

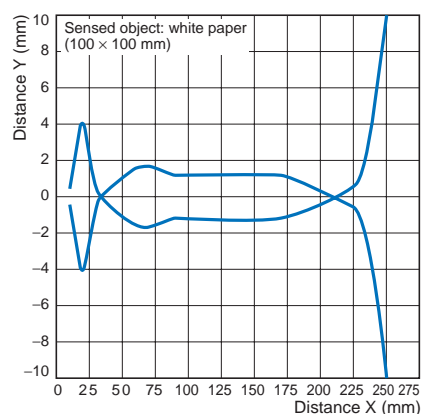

### Excess Gain vs. Sensing Distance

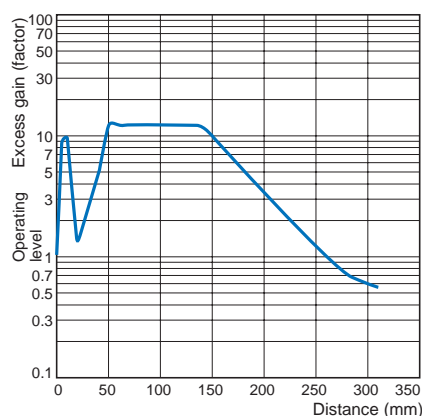

### Sensing Object Size vs. Sensing Distance

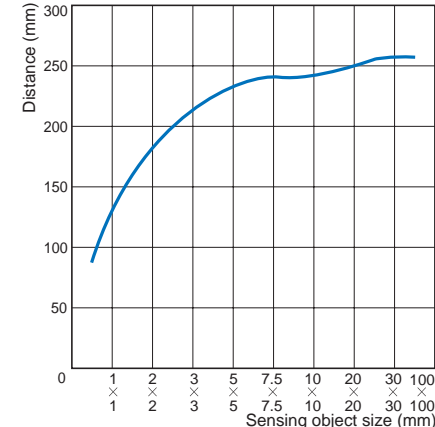

### Spot Diameter vs. Sensing Distance

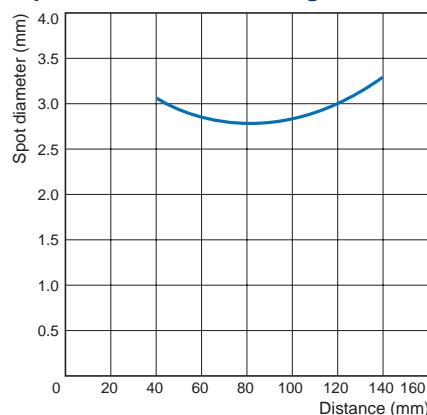

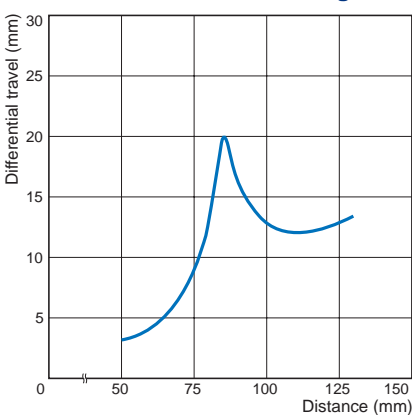

### Differential Travel vs. Sensing Distance



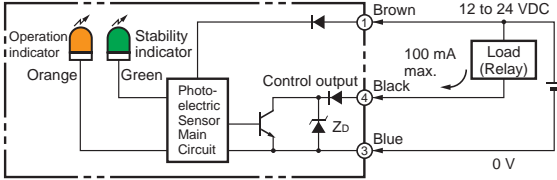

## I/O Circuit Diagrams

### NPN Output

Model	Operation mode	Timing charts	Operation selector	Output circuit
E3Z-L61 E3Z-L66	Light-ON	Incident light: [ON] [OFF] No incident light: [OFF] [ON] Operation indicator (orange): [ON] [OFF] Output transistor: [ON] [OFF] Load (e.g., relay): Operate [ON] [OFF], Reset [ON] [OFF] (Between brown and black leads)	L side (LIGHT ON)	Narrow-beam Reflective Models  Connector Pin Arrangement  Pin 2 is not used.
	Dark-ON	Incident light: [OFF] [ON] No incident light: [ON] [OFF] Operation indicator (orange): [OFF] [ON] Output transistor: [OFF] [ON] Load (e.g., relay): Operate [OFF] [ON], Reset [OFF] [ON] (Between brown and black leads)	D side (DARK ON)	

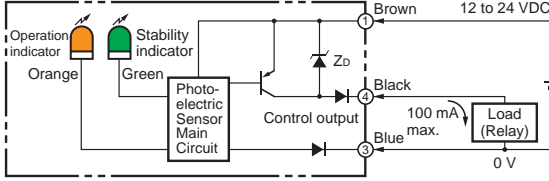
### PNP Output

Model	Operation mode	Timing charts	Operation selector	Output connector
E3Z-L81 E3Z-L86	Light-ON	Incident light: [ON] [OFF] No incident light: [OFF] [ON] Operation indicator (orange): [OFF] [ON] Output transistor: [OFF] [ON] Load (e.g., relay): Operate [ON] [OFF], Reset [ON] [OFF] (Between brown and black leads)	L side (LIGHT ON)	Narrow-beam Reflective Models  Connector Pin Arrangement  Pin 2 is not used.
	Dark-ON	Incident light: [OFF] [ON] No incident light: [ON] [OFF] Operation indicator (orange): [ON] [OFF] Output transistor: [ON] [OFF] Load (e.g., relay): Operate [OFF] [ON], Reset [OFF] [ON] (Between brown and black leads)	D side (DARK ON)	

### Plugs (Sensor I/O Connectors)

#### M8 connector

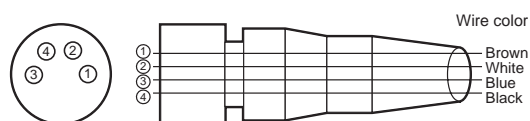

XS3F-M421-402-A  
 XS3F-M421-405-A  
 XS3F-M422-402-A  
 XS3F-M422-405-A

#### Pin arrangement

Classification	Wire color	Connector pin No.	Application
DC	Brown	1	Power supply (+V)
	White	2	---
	Blue	3	Power supply (0 V)
	Black	4	Output

Note: Pin 2 is not used.

## Safety Precautions

Refer to *Warranty and Limitations of Liability*.

### WARNING

This product is not designed or rated for ensuring safety of persons either directly or indirectly. Do not use it for such purposes.



### Precautions for Correct Use

Do not use the product in atmospheres or environments that exceed product ratings.

## Dimensions

(Unit: mm)

### Sensors

#### Pre-wired Models

E3Z-L61

E3Z-L81

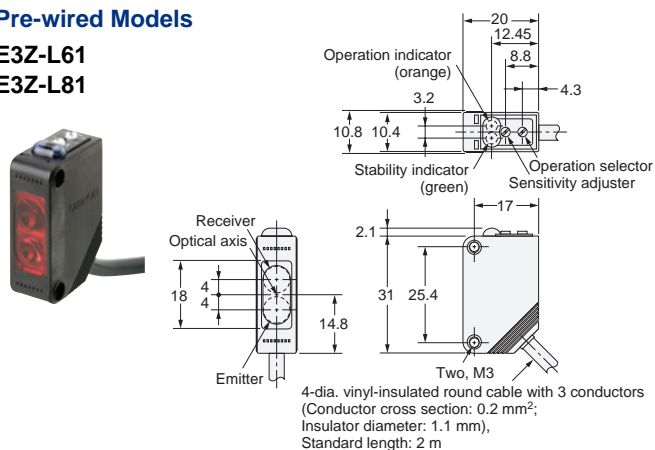

#### Connector Models

E3Z-L66

E3Z-L86

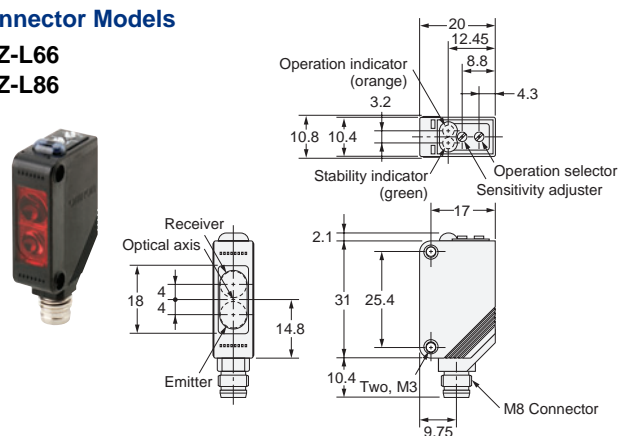

## Accessories (Order Separately)

### Mounting Brackets

## Read and Understand This Catalog

Please read and understand this catalog before purchasing the products. Please consult your OMRON representative if you have any questions or comments.

## Warranty and Limitations of Liability

### WARRANTY

OMRON's exclusive warranty is that the products are free from defects in materials and workmanship for a period of one year (or other period if specified) from date of sale by OMRON.

OMRON MAKES NO WARRANTY OR REPRESENTATION, EXPRESS OR IMPLIED, REGARDING NON-INFRINGEMENT, MERCHANTABILITY, OR FITNESS FOR PARTICULAR PURPOSE OF THE PRODUCTS. ANY BUYER OR USER ACKNOWLEDGES THAT THE BUYER OR USER ALONE HAS DETERMINED THAT THE PRODUCTS WILL SUITABLY MEET THE REQUIREMENTS OF THEIR INTENDED USE. OMRON DISCLAIMS ALL OTHER WARRANTIES, EXPRESS OR IMPLIED.

### LIMITATIONS OF LIABILITY

OMRON SHALL NOT BE RESPONSIBLE FOR SPECIAL, INDIRECT, OR CONSEQUENTIAL DAMAGES, LOSS OF PROFITS OR COMMERCIAL LOSS IN ANY WAY CONNECTED WITH THE PRODUCTS, WHETHER SUCH CLAIM IS BASED ON CONTRACT, WARRANTY, NEGLIGENCE, OR STRICT LIABILITY.

In no event shall the responsibility of OMRON for any act exceed the individual price of the product on which liability is asserted.

IN NO EVENT SHALL OMRON BE RESPONSIBLE FOR WARRANTY, REPAIR, OR OTHER CLAIMS REGARDING THE PRODUCTS UNLESS OMRON'S ANALYSIS CONFIRMS THAT THE PRODUCTS WERE PROPERLY HANDLED, STORED, INSTALLED, AND MAINTAINED AND NOT SUBJECT TO CONTAMINATION, ABUSE, MISUSE, OR INAPPROPRIATE MODIFICATION OR REPAIR.

## Application Considerations

### SUITABILITY FOR USE

OMRON shall not be responsible for conformity with any standards, codes, or regulations that apply to the combination of products in the customer's application or use of the products.

At the customer's request, OMRON will provide applicable third party certification documents identifying ratings and limitations of use that apply to the products. This information by itself is not sufficient for a complete determination of the suitability of the products in combination with the end product, machine, system, or other application or use.

The following are some examples of applications for which particular attention must be given. This is not intended to be an exhaustive list of all possible uses of the products, nor is it intended to imply that the uses listed may be suitable for the products:

- Outdoor use, uses involving potential chemical contamination or electrical interference, or conditions or uses not described in this catalog.
- Nuclear energy control systems, combustion systems, railroad systems, aviation systems, medical equipment, amusement machines, vehicles, safety equipment, and installations subject to separate industry or government regulations.
- Systems, machines, and equipment that could present a risk to life or property.

Please know and observe all prohibitions of use applicable to the products.

NEVER USE THE PRODUCTS FOR AN APPLICATION INVOLVING SERIOUS RISK TO LIFE OR PROPERTY WITHOUT ENSURING THAT THE SYSTEM AS A WHOLE HAS BEEN DESIGNED TO ADDRESS THE RISKS, AND THAT THE OMRON PRODUCTS ARE PROPERLY RATED AND INSTALLED FOR THE INTENDED USE WITHIN THE OVERALL EQUIPMENT OR SYSTEM.

### PROGRAMMABLE PRODUCTS

OMRON shall not be responsible for the user's programming of a programmable product, or any consequence thereof.

## Disclaimers

### CHANGE IN SPECIFICATIONS

Product specifications and accessories may be changed at any time based on improvements and other reasons.

It is our practice to change model numbers when published ratings or features are changed, or when significant construction changes are made. However, some specifications of the products may be changed without any notice. When in doubt, special model numbers may be assigned to fix or establish key specifications for your application on your request. Please consult with your OMRON representative at any time to confirm actual specifications of purchased products.

### DIMENSIONS AND WEIGHTS

Dimensions and weights are nominal and are not to be used for manufacturing purposes, even when tolerances are shown.

### PERFORMANCE DATA

Performance data given in this catalog is provided as a guide for the user in determining suitability and does not constitute a warranty. It may represent the result of OMRON's test conditions, and the users must correlate it to actual application requirements. Actual performance is subject to the OMRON Warranty and Limitations of Liability.

### ERRORS AND OMISSIONS

The information in this document has been carefully checked and is believed to be accurate; however, no responsibility is assumed for clerical, typographical, or proofreading errors, or omissions.

2013.1

In the interest of product improvement, specifications are subject to change without notice.

**OMRON Corporation**  
Industrial Automation Company

<http://www.ia.omron.com/>

(c)Copyright OMRON Corporation 2013 All Right Reserved.

# Mouser Electronics

Authorized Distributor

Click to View Pricing, Inventory, Delivery & Lifecycle Information:

[Omron:](#)

[E3Z-L61](#) [E3Z-L66](#) [E3Z-L81](#) [E3Z-L86](#)