

Rectifier Diode Avalanche Diode

Replacements see page 3

$$V_{RRM} = 1200-1800 \text{ V}$$

$$I_{F(RMS)} = 40 \text{ A}$$

$$I_{F(AV)M} = 25 \text{ A}$$

V_{RSM} V	$V_{(BR)min}$ ① V	V_{RRM} V	Anode ↑ on stud	Cathode ↓ on stud
1300	-	1200	DS 17-12A	DSI 17-12A
1300	1300	1200	DSA 17-12A	DSAI 17-12A
1700	1750	1600	DSA 17-16A	DSAI 17-16A
1900	1950	1800	DSA 17-18A	DSAI 17-18A

① Only for Avalanche Diodes

DO-203 AA

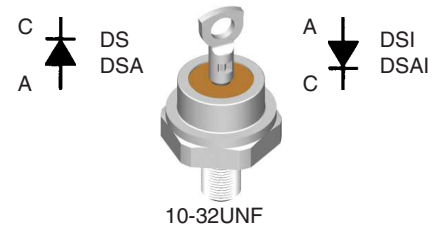

A = Anode C = Cathode

Symbol	Test Conditions	Maximum Ratings	
$I_{F(RMS)}$	$T_{VJ} = T_{VJM}$	40	A
$I_{F(AV)M}$	$T_{case} = 125^{\circ}\text{C}; 180^{\circ}$ sine	25	A
P_{RSM}	DSA(I) types, $T_{VJ} = T_{VJM}, t_p = 10 \mu\text{s}$	7	kW
I_{FSM}	$T_{VJ} = 45^{\circ}\text{C}; V_R = 0$	t = 10 ms (50 Hz), sine t = 8.3 ms (60 Hz), sine	370 A 400 A
	$T_{VJ} = T_{VJM}; V_R = 0$	t = 10 ms (50 Hz), sine t = 8.3 ms (60 Hz), sine	300 A 320 A
I^2t	$T_{VJ} = 45^{\circ}\text{C}; V_R = 0$	t = 10 ms (50 Hz), sine t = 8.3 ms (60 Hz), sine	680 A ² s 660 A ² s
	$T_{VJ} = T_{VJM}; V_R = 0$	t = 10 ms (50 Hz), sine t = 8.3 ms (60 Hz), sine	450 A ² s 430 A ² s
T_{VJ}		-40...+180	°C
T_{VJM}		180	°C
T_{stg}		-40...+180	°C
M_d	Mounting torque	2.2-2.8	Nm
		19-25	lb.in.
Weight		6	g

Features

- International standard package, JEDEC DO-203 AA (DO-4)
- Planar glassivated chips

Applications

- Supplies for DC power equipment
- DC supply for PWM inverter
- Field supply for DC motors
- Battery DC power supplies

Advantages

- Space and weight savings
- Simple mounting
- Improved temperature and power cycling
- Reduced protection circuits

Dimensions in mm (1 mm = 0.0394")

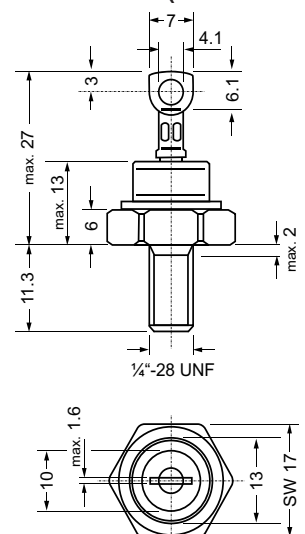

Symbol	Test Conditions	Characteristic Values	
I_R	$T_{VJ} = T_{VJM}; V_R = V_{RRM}$	≤ 4	mA
V_F	$I_F = 55 \text{ A}; T_{VJ} = 25^{\circ}\text{C}$	≤ 1.36	V
V_{T0}	For power-loss calculations only	0.85	V
r_T	$T_{VJ} = T_{VJM}$	8	mΩ
R_{thJC}	DC current	1.5	K/W
R_{thJH}	DC current	2.1	K/W
d_s	Creepage distance on surface	2.05	mm
d_A	Strike distance through air	2.05	mm
a	Max. allowable acceleration	100	m/s ²

Data according to IEC 60747

IXYS reserves the right to change limits, test conditions and dimensions

20190130b

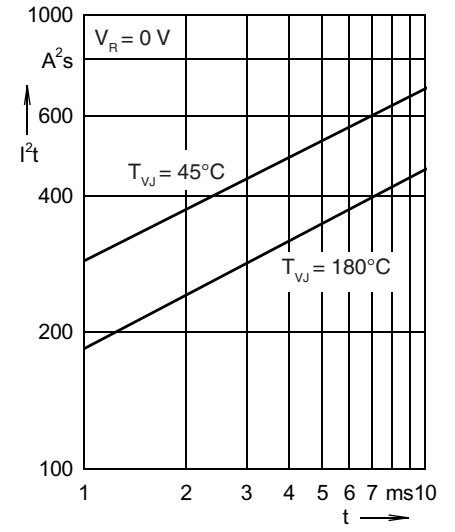
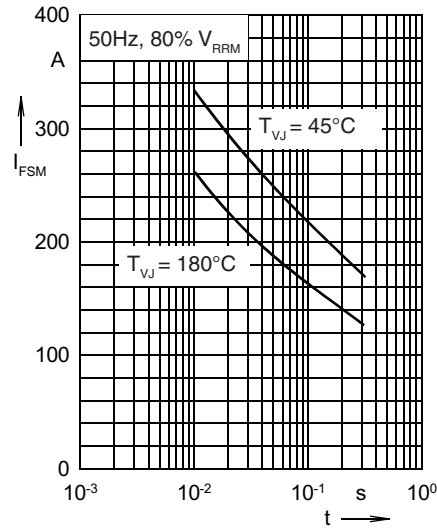
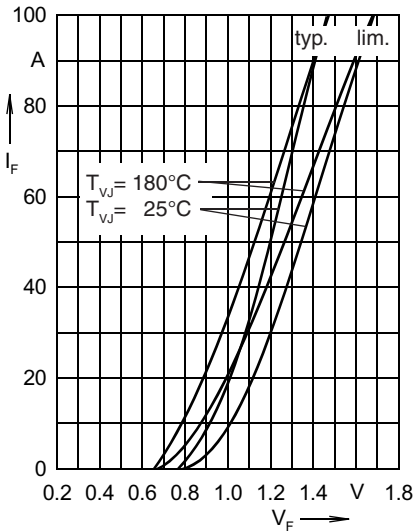

Fig. 1 Forward characteristics

Fig. 2 Surge overload current
 I_{FSM} : crest value, t: duration

Fig. 3 I^2t versus time (1-10 ms)

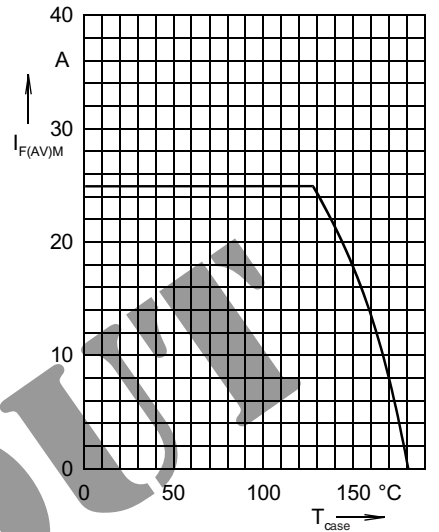
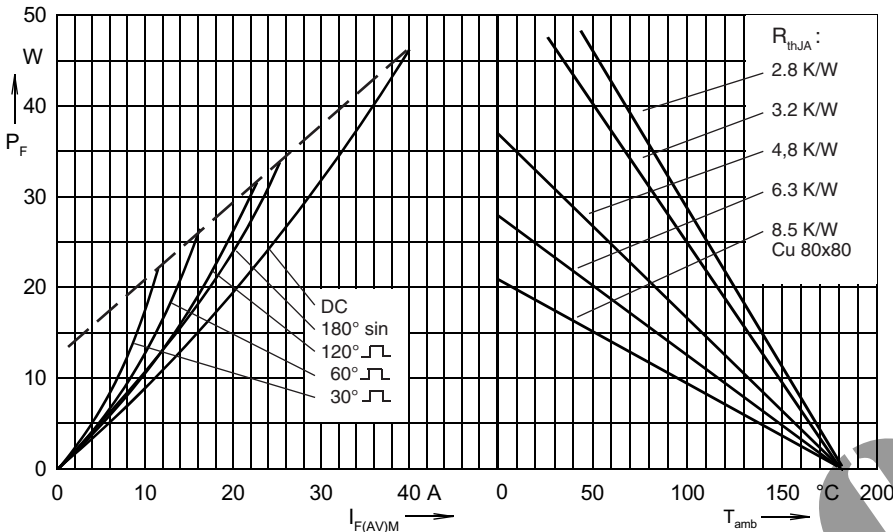
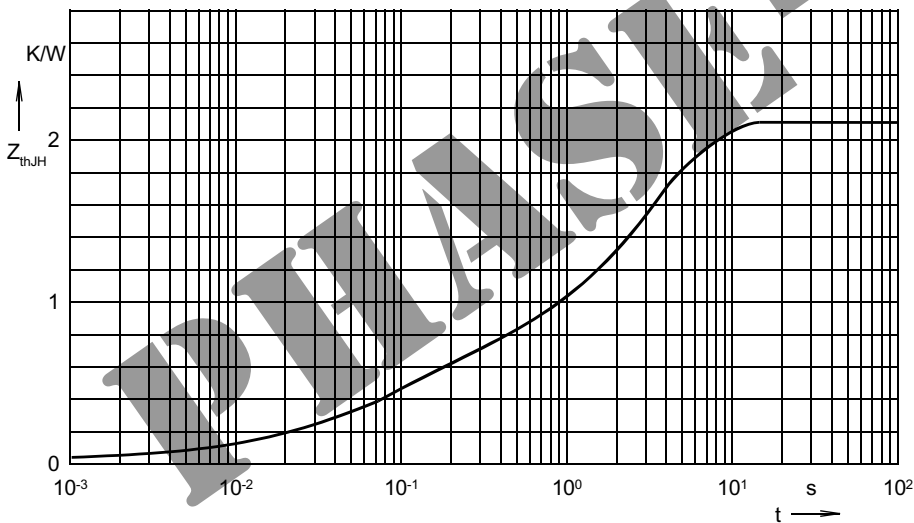

Fig. 4 Power dissipation versus forward current and ambient temperature

Fig. 5 Max. forward current at case temperature 180° sine



R_{thJH} for various conduction angles d:

d	R_{thJH} (K/W)
DC	2.10
180°	2.23
120°	2.33
60°	2.53
30°	2.72

Constants for Z_{thJH} calculation:

i	R_{thi} (K/W)	t_i (s)
1	0.1006	0.0021
2	0.5311	0.0881
3	0.8683	2.968
4	0.600	3.20

Fig. 6 Transient thermal impedance junction to heatsink

Type	Replacements
DSI17-12A	DSI2x55-12A; DMA50I1200HA
DSAI17-12A	DSI2x55-12A; DMA50I1200HA
DSAI17-16A	DSI2x55-12A; DMA50I1200HA
DSAI17-18A	contact factory
DS17-12A	DSI2x55-12A; DMA50I1200HA
DSA17-12A	DSI2x55-12A; DMA50I1200HA
DSA17-16A	DSI2x55-12A; DMA50I1200HA
DSA17-18A	contact factory

PHASE-OUT