

THIS DRAWING IS UNPUBLISHED. RELEASED FOR PUBLICATION  
 © COPYRIGHT - By - ALL RIGHTS RESERVED.

LOC		DIST		REVISIONS			
P	LTR	DESCRIPTION		DATE	DWN	APVD	
H2		REVISED PER ECO-11-004587		11MAR11	RK	HMR	

LOC	DIST	P	LTR	DESCRIPTION	DATE	DWN	APVD	180.7	188.2	18	1-1546306-8
-	-	-	-	-	-	-	-	-	-	-	-
-	-	-	-	-	-	-	-	171.2	178.7	17	1-1546306-7
-	-	-	-	-	-	-	-	161.7	169.2	16	1-1546306-6
△△△△	-	-	-	-	-	-	-	152.2	159.7	15	6-1546306-2
-	-	-	-	-	-	-	-	152.2	159.7	15	1-1546306-5
-	-	-	-	-	-	-	-	142.7	150.2	14	1-1546306-4
-	-	-	-	-	-	-	-	133.2	140.7	13	1-1546306-3
△△	-	-	-	-	-	-	-	123.7	131.2	12	4-1546306-0
△△	-	-	-	-	-	-	-	123.7	131.2	12	3-1546306-3
-	-	-	-	-	-	-	-	123.7	131.2	12	1-1546306-2
△	-	-	-	11	-	-	-	114.2	121.7	11	5-1546306-2
△△	-	-	-	-	2	-	-	114.2	121.7	11	3-1546306-4
△	-	-	-	-	-	-	-	114.2	121.7	11	3-1546306-1
-	-	-	-	-	-	-	-	114.2	121.7	11	1-1546306-1
△	-	-	-	-	-	-	10	104.7	112.2	10	6-1546306-0
△△	-	-	-	-	-	-	-	104.7	112.2	10	5-1546306-8
-	-	-	-	-	-	-	-	104.7	112.2	10	1-1546306-0
△△△	-	4	9	-	-	-	-	95.2	102.7	9	6-1546306-3
△△	-	-	-	-	-	-	-	95.2	102.7	9	5-1546306-6
-	-	-	-	-	-	-	-	95.2	102.7	9	1546306-9
-	-	-	-	-	-	-	8	85.7	93.2	8	5-1546306-9
△△	-	-	-	-	-	-	-	85.7	93.2	8	3-1546306-9
-	-	-	-	-	-	-	-	85.7	93.2	8	1546306-8
△△	-	-	-	-	-	-	-	76.2	83.7	7	5-1546306-5
△	-	-	-	1	-	7	-	76.2	83.7	7	5-1546306-0
-	-	-	-	-	-	-	-	76.2	83.7	7	4-1546306-5
△	-	-	-	-	-	-	-	76.2	83.7	7	3-1546306-7
-	-	-	-	-	-	-	-	76.2	83.7	7	1546306-7
△△	-	-	-	-	-	-	-	66.7	74.2	6	5-1546306-4
△△	-	-	-	-	-	1	6	66.7	74.2	6	4-1546306-9
-	-	-	-	-	6	-	-	66.7	74.2	6	4-1546306-8
-	-	-	-	-	-	-	-	66.7	74.2	6	4-1546306-4
△	-	-	-	-	-	-	-	66.7	74.2	6	3-1546306-6
-	-	-	-	-	-	-	-	66.7	74.2	6	1546306-6
△	-	-	-	-	-	-	5	57.2	64.7	5	5-1546306-7
△	-	5	5	-	-	-	-	57.2	64.7	5	5-1546306-3
△△	-	-	-	-	-	-	-	57.2	64.7	5	4-1546306-7
-	-	-	-	-	-	-	-	57.2	64.7	5	4-1546306-3
△	-	-	-	-	-	-	-	57.2	64.7	5	3-1546306-5
-	-	-	-	-	-	-	-	57.2	64.7	5	1546306-5
-	-	-	-	-	-	-	-	57.2	64.7	5	4-1546306-2
△△	-	-	-	-	-	-	-	47.7	55.2	4	3-1546306-8
-	-	-	-	-	-	-	-	47.7	55.2	4	1546306-4
-	-	3	3	-	-	-	-	38.2	45.7	3	6-1546306-1
-	-	-	-	-	-	-	-	38.2	45.7	3	5-1546306-1
-	-	-	-	-	-	-	-	38.2	45.7	3	1546306-3
△	-	-	-	-	-	2	2	28.7	36.2	2	4-1546306-6
-	-	-	-	-	2	2	2	28.7	36.2	2	4-1546306-1
-	-	-	-	-	-	-	-	28.7	36.2	2	1546306-2

△△ SCREW ON ONE SIDE

NOTES	⑬ QC TAB .187 SS FLAT	⑫ QC TAB .187 SS FLAT	⑪ QC TAB .187 SS 90°	⑩ JUMPER	⑨ QC TAB DBL SIDE 90° .250	⑧ QC TAB DBL SIDE 45° .250	⑦ QC TAB DBL SIDE FLAT .250	⑥ QC TAB DBL SIDE 90° .187	⑤ QC TAB DBL SIDE 45° .187	④ QC TAB DBL SIDE FLAT .187	③ QC TAB SGL SIDE .250	② QC TAB SGL SIDE 45° .250	① QC TAB SGL SIDE FLAT .250	DIM B	DIM A	NO. OF POS.	PART NO.
-------	-----------------------	-----------------------	----------------------	----------	----------------------------	----------------------------	-----------------------------	----------------------------	----------------------------	-----------------------------	------------------------	----------------------------	-----------------------------	-------	-------	-------------	----------

THIS DRAWING IS A CONTROLLED DOCUMENT.

DWN	S SCHLEGEL	20AUG2002
CHK	C RICHARD	8/20/02
APVD	C RICHARD	8/20/02
PRODUCT SPEC	9.50MM (.374) DBL ROW BARRIER STRIP W/O WASHER	
APPLICATION SPEC	-	
WEIGHT	-	-
CUSTOMER DRAWING	SCALE NTS	SHEET 1 OF 3

SIZE A2 CAGE CODE 00779 DRAWING NO. C=1546306 RESTRICTED TO -

THIS DRAWING IS UNPUBLISHED. RELEASED FOR PUBLICATION  
 © COPYRIGHT - By - ALL RIGHTS RESERVED.

LOC		DIST		REVISIONS			
P	LTR	DESCRIPTION	DATE	DWN	APVD		
-	-	SEE SHEET 1	-	-	-		

PHYSICAL PROPERTIES:  
 HOUSING MATERIAL: THERMOPLASTIC, PC  
 FLAMMABILITY: UL94V-0 COLOR: BLACK  
 MAX BOW/WARP: .0056 IN/IN.

TERMINAL:  
 TERMINALS: BRASS, TIN PLATED  
 SCREWS: 6-32, STEEL, NICKEL PLATED

MECHANICAL:  
 PITCH (TERMINAL SPACING): 9.50mm(.374")  
 WIRE RANGE: 12-22 AWG  
 RECOMMENDED TIGHTENING TORQUE: 12IN-LBS MAX.

ELECTRICAL PROPERTIES:  
 MAXIMUM CURRENT: 20A  
 OPERATING VOLTAGE: 300V

ENVIRONMENTAL PROPERTIES:  
 OPERATING TEMP RANGE: -40°C TO +120°C.

- 1 SEE FIGURE.
- 2 MARKED WITH WHITE INK.
- 3 PRELIMINARY PART NUMBER.
- 4 SCREWS AND TERMINALS ARE NICKEL PLATED BRASS.
- 5 STAINLESS STEEL SCREWS.
- 6 SCREWS ARE NICKEL PLATED BRASS.
- 7 WIRE CLAMP SCREWS TO BE USED ONLY ON SIDE OPPOSITE QC TABS.
- 8 TE CONNECTIVITY LOGO LOCATED APPROXIMATE AREA SHOWN.

-- SELECT LOAD CHART --

-	-	4-5,5-6	-	-	-	-	ALL	-	-	-	-	11	3-1546306-4												
-	-	-	-	-	-	ALL	1-3	-	-	-	-	10	6-1546306-0												
-	-	1,2	-	-	ALL	-	-	-	-	-	-	7	5-1546306-0												
-	-	-	-	1	ALL	-	-	-	-	-	-	6	4-1546306-9												
12	QC TAB .187 SS FLAT	11	QC TAB .187 SS 90°	10	JUMPER	9	QC TAB DBL SIDE 90° .250	8	QC TAB DBL SIDE 45° .250	7	QC TAB DBL SIDE FLAT .250	6	QC TAB DBL SIDE 90° .187	5	QC TAB DBL SIDE 45° .187	4	QC TAB DBL SIDE FLAT .187	3	QC TAB SGL SIDE 90° .250	2	QC TAB SGL SIDE 45° .250	1	QC TAB SGL SIDE FLAT .250	NO. OF POS.	PART NUMBER
POSITIONS LOADED																									

-	-	-	-	-	-	-	-	-	-	-	-	-	-	-	-	-	-	-	-	-	-	-	-	-	294.7	302.2	30	3-1546306-0		
-	-	-	-	-	-	-	-	-	-	-	-	-	-	-	-	-	-	-	-	-	-	-	-	-	-	285.2	292.7	29	2-1546306-9	
-	-	-	-	-	-	-	-	-	-	-	-	-	-	-	-	-	-	-	-	-	-	-	-	-	-	275.7	283.2	28	2-1546306-8	
-	-	-	-	-	-	-	-	-	-	-	-	-	-	-	-	-	-	-	-	-	-	-	-	-	-	266.2	273.7	27	2-1546306-7	
-	-	-	-	-	-	-	-	-	-	-	-	-	-	-	-	-	-	-	-	-	-	-	-	-	-	256.7	264.2	26	2-1546306-6	
-	-	-	-	-	-	-	-	-	-	-	-	-	-	-	-	-	-	-	-	-	-	-	-	-	-	247.2	254.7	25	2-1546306-5	
-	-	-	-	-	-	-	-	-	-	-	-	-	-	-	-	-	-	-	-	-	-	-	-	-	-	237.7	245.2	24	2-1546306-4	
-	-	-	-	-	-	-	-	-	-	-	-	-	-	-	-	-	-	-	-	-	-	-	-	-	-	228.2	235.7	23	2-1546306-3	
-	-	-	-	-	-	-	-	-	-	-	-	-	-	-	-	-	-	-	-	-	-	-	-	-	-	218.7	226.2	22	2-1546306-2	
-	-	-	-	-	-	-	-	-	-	-	-	-	-	-	-	-	-	-	-	-	-	-	-	-	-	209.2	216.7	21	2-1546306-1	
1	2	3	4	5	6	7	8	9	10	11	12	13	14	15	16	17	18	19	20	21	22	23	24	25	26	27	28	29	30	3-1546306-2
-	-	-	-	-	-	-	-	-	-	-	-	-	-	-	-	-	-	-	-	-	-	-	-	-	-	-	199.7	207.2	20	2-1546306-0
-	-	-	-	-	-	-	-	-	-	-	-	-	-	-	-	-	-	-	-	-	-	-	-	-	-	-	199.7	207.2	20	2-1546306-0
-	-	-	-	-	-	-	-	-	-	-	-	-	-	-	-	-	-	-	-	-	-	-	-	-	-	-	190.2	197.7	19	1-1546306-9
NOTES	13	QC TAB .187 SS FLAT	12	QC TAB .187 SS FLAT	11	QC TAB .187 SS 90°	10	JUMPER	9	QC TAB DBL SIDE 90° .250	8	QC TAB DBL SIDE 45° .250	7	QC TAB DBL SIDE FLAT .250	6	QC TAB DBL SIDE 90° .187	5	QC TAB DBL SIDE 45° .187	4	QC TAB DBL SIDE FLAT .187	3	QC TAB SGL SIDE 90° .250	2	QC TAB SGL SIDE 45° .250	1	QC TAB SGL SIDE FLAT .250	DIM B	DIM A	NO. OF POS.	PART NO.

1 2 SPL MARKING

THIS DRAWING IS A CONTROLLED DOCUMENT.		DWN S SCHLEGEL 20AUG2002	 TE Connectivity	
DIMENSIONS: MM		CHK C RICHARD 8/20/02		
TOLERANCES UNLESS OTHERWISE SPECIFIED:		APVD C RICHARD 8/20/02	NAME 9.50MM (.374) DBL ROW BARRIER STRIP W/O WASHER	
0 PLC ± - 1 PLC ± 0.3 2 PLC ± 0.25 3 PLC ± - 4 PLC ± - ANGLES ± 2°		PRODUCT SPEC -	SIZE A2	
MATERIAL		APPLICATION SPEC -	CAGE CODE 00779	DRAWING NO 1546306
FINISH		WEIGHT -	RESTRICTED TO -	SCALE NTS
		CUSTOMER DRAWING	SHEET 2 of 3	REV H2

THIS DRAWING IS UNPUBLISHED. RELEASED FOR PUBLICATION  
 © COPYRIGHT - By - ALL RIGHTS RESERVED.

LOC		DIST		REVISIONS			
P	LTR	DESCRIPTION	DATE	DWN	APVD		
-	-	SEE SHEET 1	-	-	-	-	-

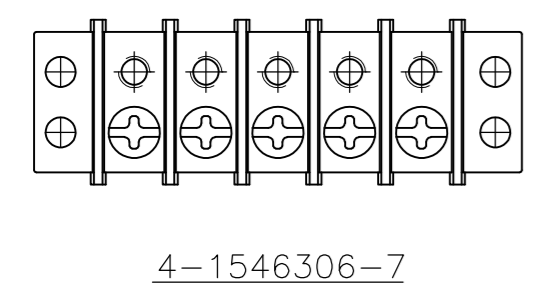
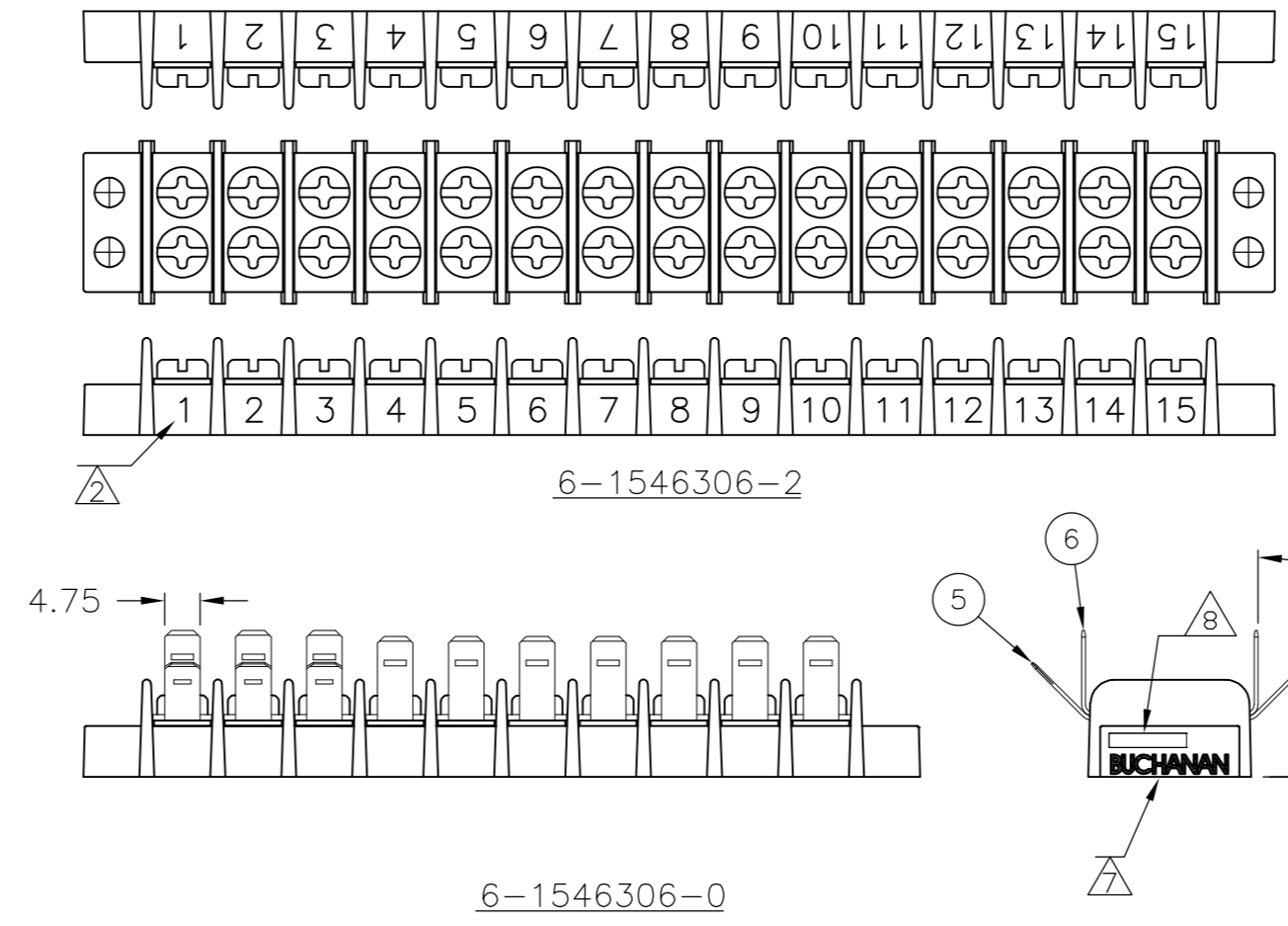
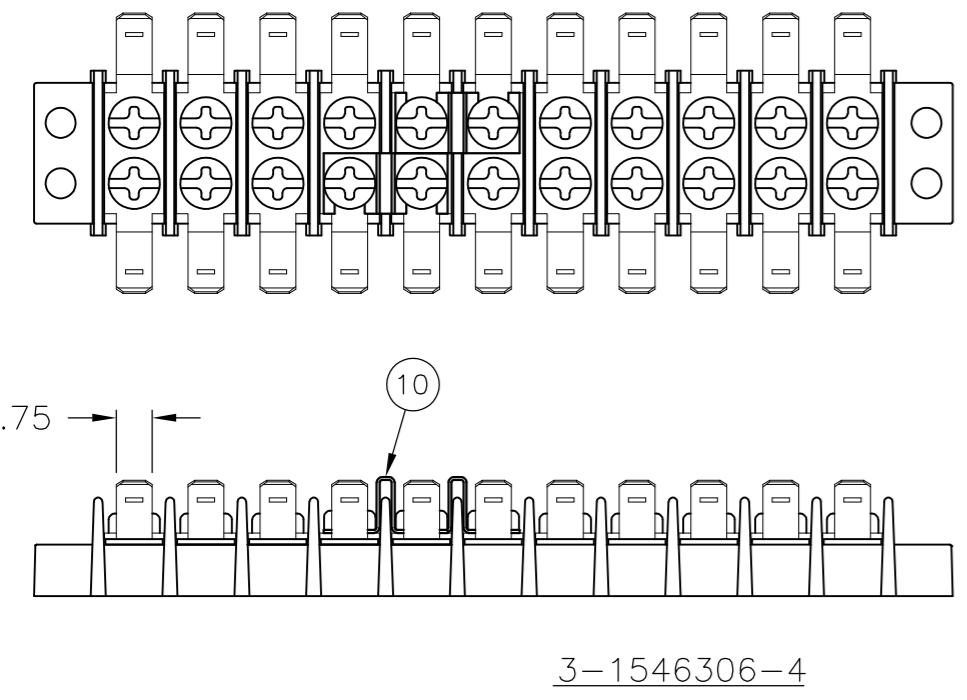
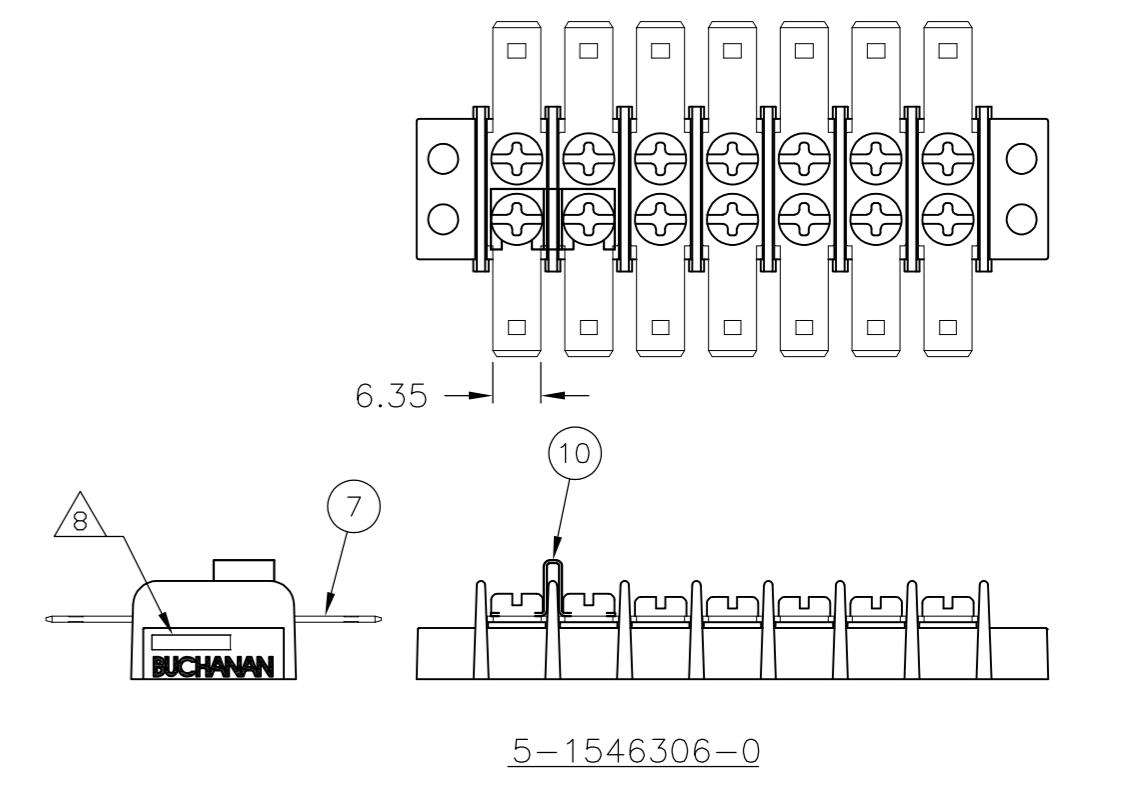
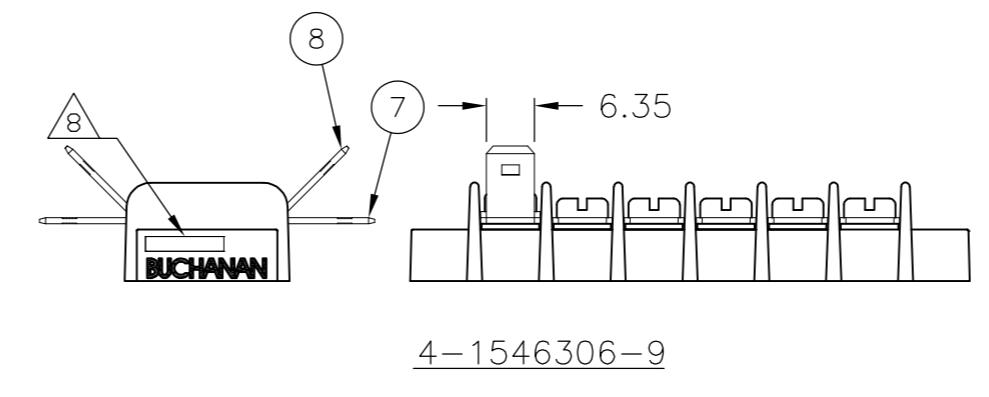
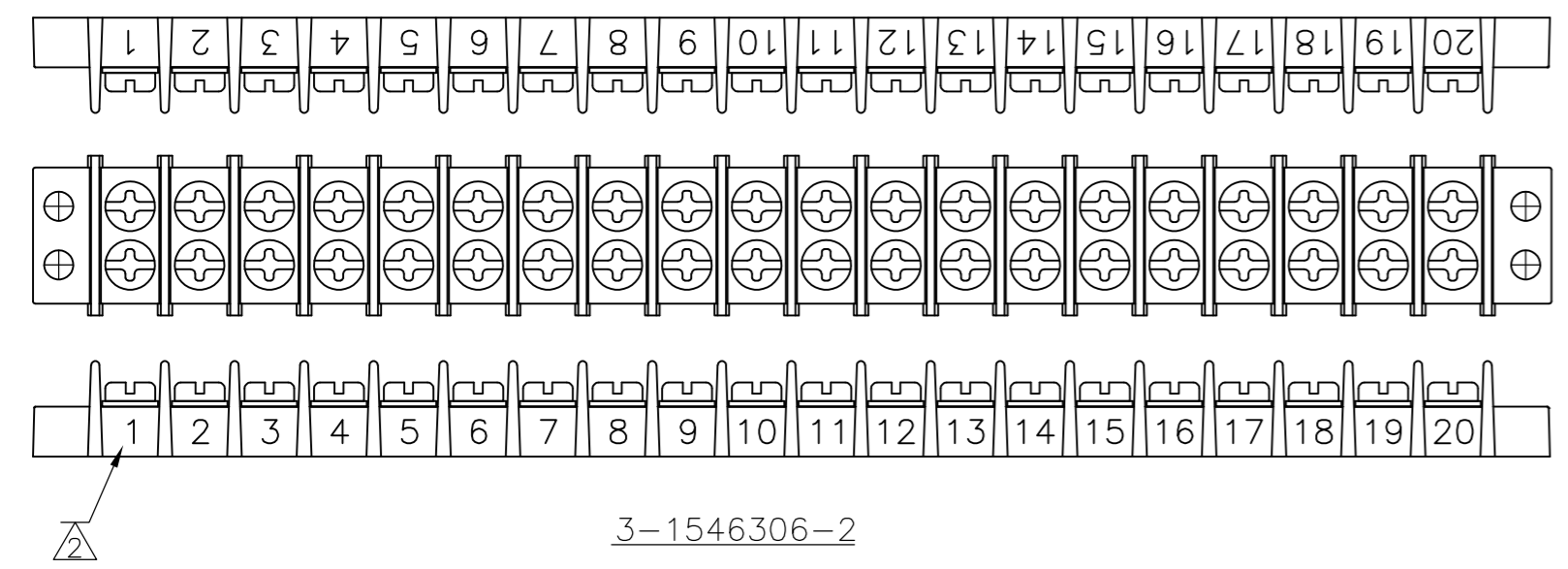
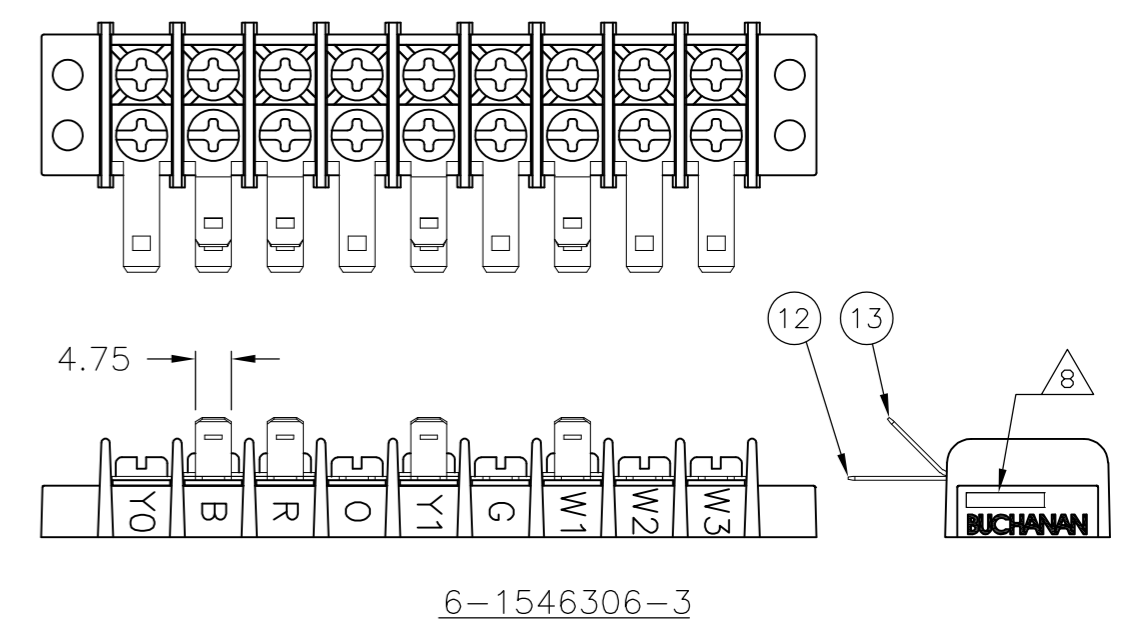

THIS DRAWING IS A CONTROLLED DOCUMENT.		DWN S SCHLEGEL 20AUG2002	TE Connectivity	
DIMENSIONS: MM		CHK C RICHARD 8/20/02		
TOLERANCES UNLESS OTHERWISE SPECIFIED:		APVD C RICHARD 8/20/02	NAME 9.50MM (.374) DBL ROW BARRIER STRIP W/O WASHER	
0 PLC ± -		PRODUCT SPEC	SIZE A2	
1 PLC ± 0.3		APPLICATION SPEC	CAGE CODE 00779	
2 PLC ± 0.25		WEIGHT	DRAWING NO C=1546306	
3 PLC ± -		FINISH	RESTRICTED TO	
4 PLC ± -		CUSTOMER DRAWING	SCALE NTS	
ANGLES ± 2°			SHEET 3 OF 3	
MATERIAL			REV H2	

# Mouser Electronics

Authorized Distributor

Click to View Pricing, Inventory, Delivery & Lifecycle Information:

[TE Connectivity:](#)

[1-1546306-8](#)