

MBRS2H100T3G, NBRS2H100T3G, MBRA2H100T3G, NRVBA2H100T3G SBRA2H100T3G



ON Semiconductor®

www.onsemi.com

Surface Mount Schottky Power Rectifier

SMA/SMB Power Surface Mount Package

This device employs the Schottky Barrier principle in a metal-to-silicon power rectifier. Features epitaxial construction with oxide passivation and metal overlay contact. Ideally suited for low voltage, high frequency switching power supplies; free wheeling diodes and polarity protection diodes.

Features

- Compact Package with J-Bend Leads Ideal for Automated Handling
- Highly Stable Oxide Passivated Junction
- Guard-Ring for Overvoltage Protection
- Low Forward Voltage Drop
- NBR and NRVB Prefixes for Automotive and Other Applications Requiring Unique Site and Control Change Requirements; AEC-Q101 Qualified and PPAP Capable*

Mechanical Characteristics

- Case: Molded Epoxy
- Epoxy Meets UL 94 V-0 @ 0.125 in
- Weight: 70 mg (SMA), 95 mg (SMB) (Approximately)
- Cathode Polarity Band
- Lead and Mounting Surface Temperature for Soldering Purposes: 260°C Max. for 10 Seconds
- Finish: All External Surfaces Corrosion Resistant and Terminal Leads are Readily Solderable
- ESD Ratings:
 - ◆ Machine Model = C
 - ◆ Human Body Model = 3B
- These Devices are Pb-Free and are RoHS Compliant
- Device Meets MSL1 Requirements

SCHOTTKY BARRIER RECTIFIER 2.0 AMPERES, 100 VOLTS

MARKING DIAGRAMS



SMA
CASE 403D

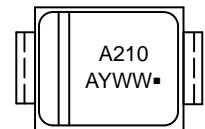

SMB
CASE 403A

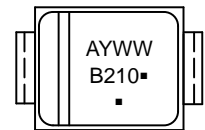

A210 = MBRA2H100T3G
NRVBA2H100T3G

B210 = MBRS2H100T3G
NBRS2H100T3G

A = Assembly Location

Y = Year

WW = Work Week

■ = Pb-Free Package

(Note: Microdot may be in either location)

**The Assembly Location code (A) is front side optional. In cases where the Assembly Location is stamped in the package, the front side assembly code may be blank.

ORDERING INFORMATION

Device	Package	Shipping†
MBRA2H100T3G, NRVBA2H100T3G*	SMA (Pb-Free)	5,000 / Tape & Reel
MBRS2H100T3G, NBRS2H100T3G*, NBRS2H100T3G-VF01*, SBRA2H100T3G	SMB (Pb-Free)	2,500 / Tape & Reel

†For information on tape and reel specifications, including part orientation and tape sizes, please refer to our Tape and Reel Packaging Specifications Brochure, BRD8011/D.

MBRS2H100T3G, NBR2H100T3G, MBRA2H100T3G, NRVBA2H100T3G

MAXIMUM RATINGS

Rating	Symbol	Value	Unit
Peak Repetitive Reverse Voltage Working Peak Reverse Voltage DC Blocking Voltage	V_{RRM} V_{RWM} V_R	100	V
Average Rectified Forward Current ($T_L = 150^\circ\text{C}$)	I_O	2.0	A
Non-Repetitive Peak Surge Current (Surge Applied at Rated Load Conditions Halfwave, Single Phase, 60 Hz)	I_{FSM}	130	A
Storage Temperature Range	T_{stg}	-65 to +175	$^\circ\text{C}$
Operating Junction Temperature (Note 1)	T_J	-65 to +175	$^\circ\text{C}$

Stresses exceeding those listed in the Maximum Ratings table may damage the device. If any of these limits are exceeded, device functionality should not be assumed, damage may occur and reliability may be affected.

- The heat generated must be less than the thermal conductivity from Junction-to-Ambient: $dP_D/dT_J < 1/R_{\theta JA}$.

THERMAL CHARACTERISTICS

Characteristic	Symbol	Value	Unit
Thermal Resistance, Junction-to-Lead (Note 2) MBRA2H100T3G, NRVBA2H100T3G MBRS2H100T3G, NBR2H100T3G	Ψ_{JCL}	14 12	$^\circ\text{C/W}$
Thermal Resistance, Junction-to-Ambient (Note 2) MBRA2H100T3G, NRVBA2H100T3G MBRS2H100T3G, NBR2H100T3G	$R_{\theta JA}$	75 71	$^\circ\text{C/W}$
Thermal Resistance, Junction-to-Ambient (Note 3) MBRA2H100T3G, NRVBA2H100T3G MBRS2H100T3G, NBR2H100T3G	$R_{\theta JA}$	275 230	$^\circ\text{C/W}$

- Mounted with 700 mm square copper pad size (Approximately 1 inch square) 1 oz FR4 Board.
- Mounted with minimum recommended pad size 1 oz FR4 Board.

ELECTRICAL CHARACTERISTICS

Characteristic	Symbol	Value		Unit
		$T_J = 25^\circ\text{C}$	$T_J = 125^\circ\text{C}$	
Maximum Instantaneous Forward Voltage (Note 4) ($I_F = 2.0\text{ A}$)	V_F	0.79	0.65	V
Maximum Instantaneous Reverse Current (Note 4) ($V_R = 100\text{ V}$)	I_R	0.008	1.5	mA

- Pulse Test: Pulse Width $\leq 380\ \mu\text{s}$, Duty Cycle $\leq 2.0\%$.

TYPICAL CHARACTERISTICS

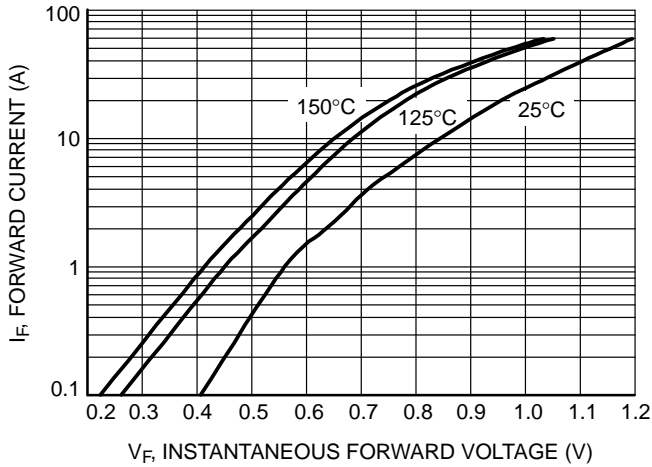

Figure 1. Typical Forward Voltage

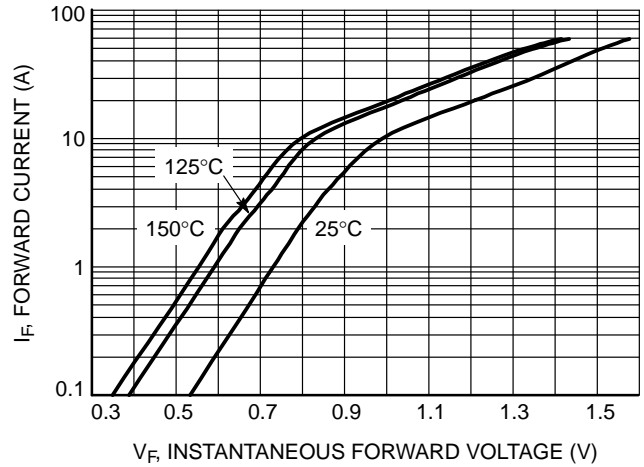

Figure 2. Maximum Forward Voltage

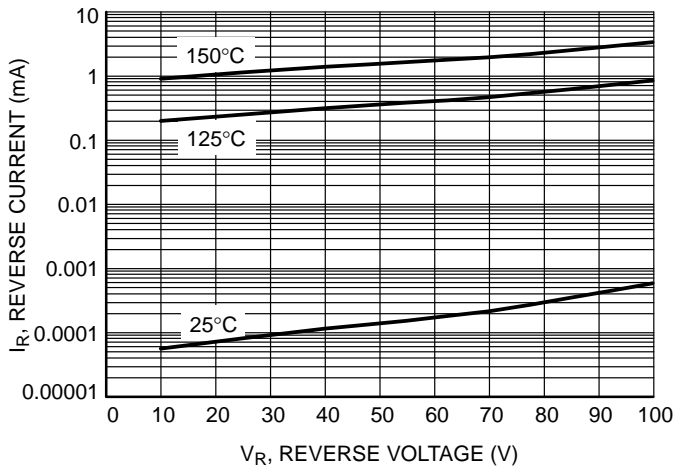

Figure 3. Typical Reverse Current

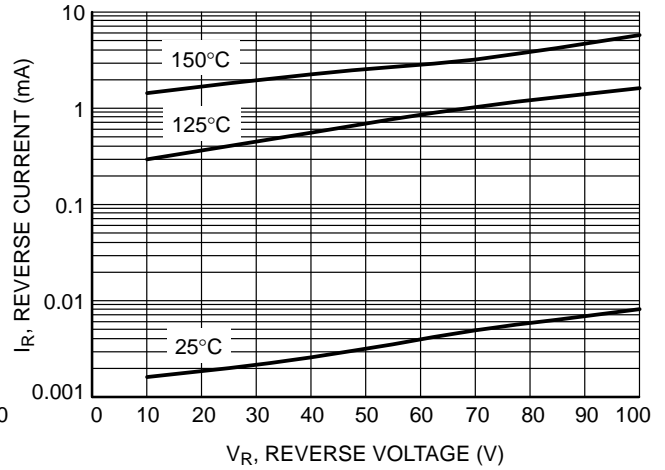

Figure 4. Maximum Reverse Current

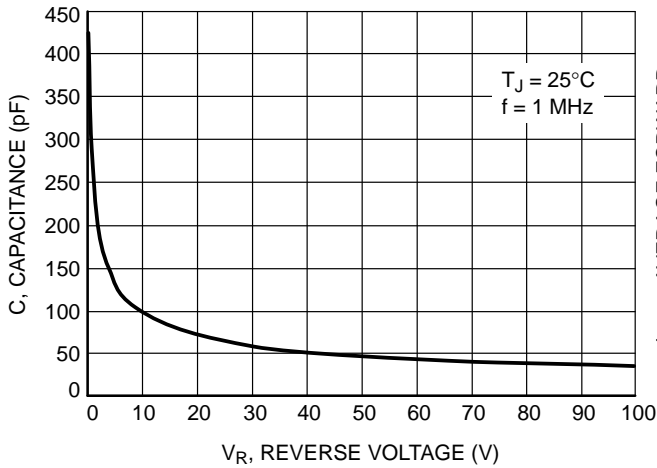

Figure 5. Typical Capacitance

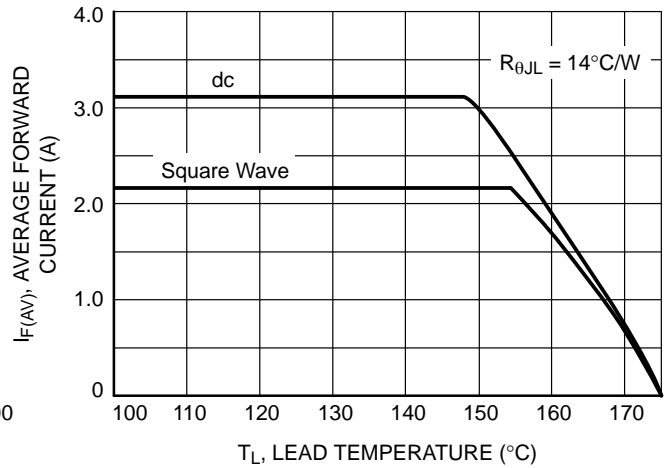

Figure 6. Current Derating – Lead

MBRS2H100T3G, NBR2H100T3G, MBRA2H100T3G, NRVBA2H100T3G

TYPICAL CHARACTERISTICS

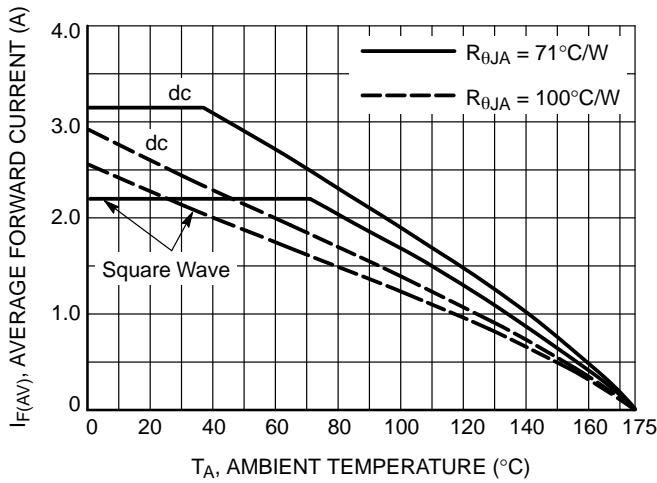

Figure 7. Current Derating, Ambient

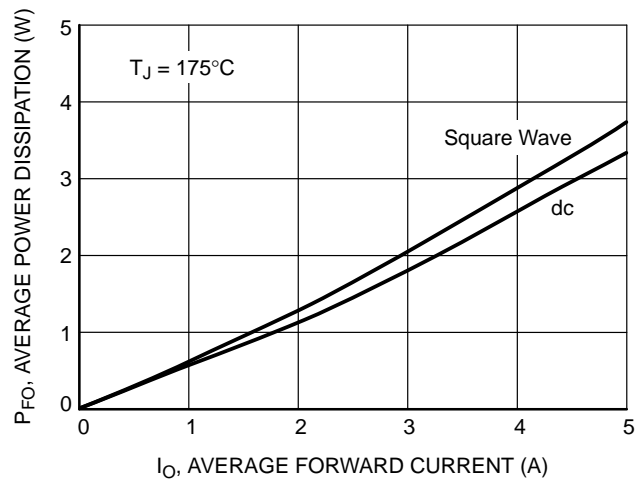

Figure 8. Maximum Forward Power Dissipation

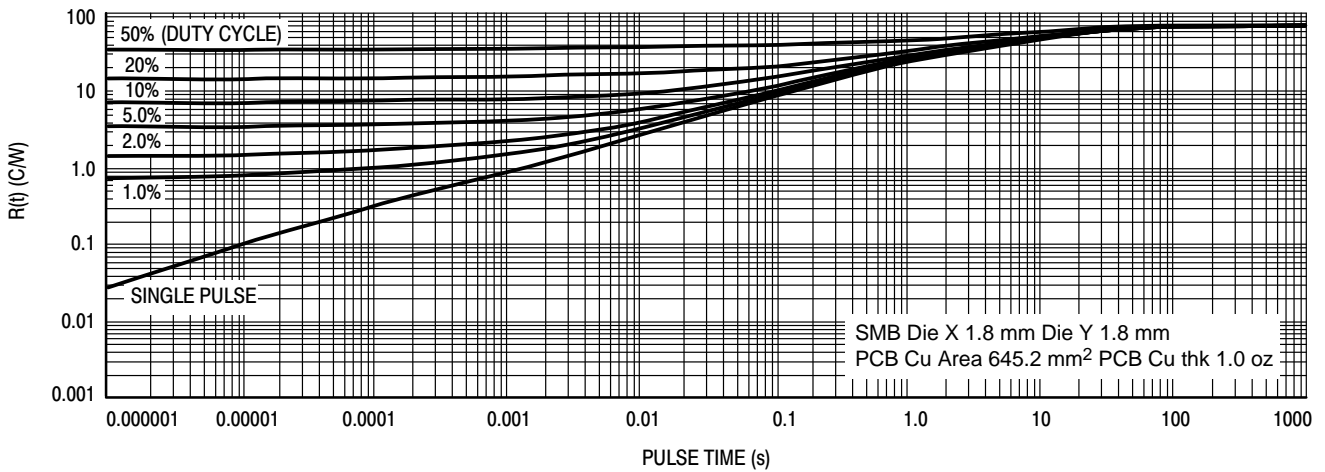

Figure 9. Thermal Response, Junction-to-Ambient (1 inch pad) – MBRS2H100T3G/NBR2H100T3G

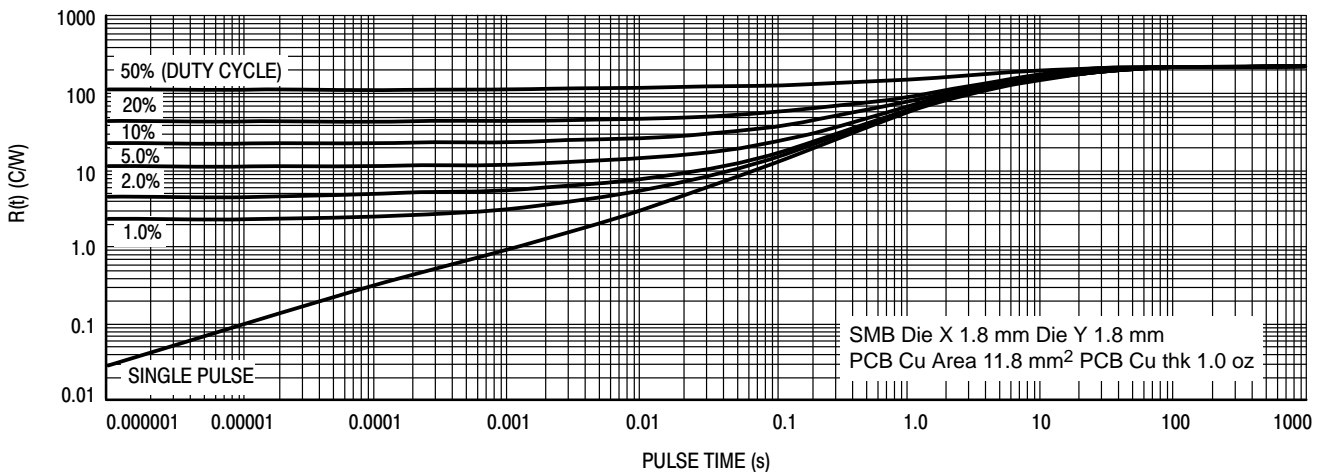

Figure 10. Thermal Response, Junction-to-Ambient (min pad) – MBRS2H100T3G/NBR2H100T3G

MBRS2H100T3G, NBR2H100T3G, MBRA2H100T3G, NRVBA2H100T3G

TYPICAL CHARACTERISTICS

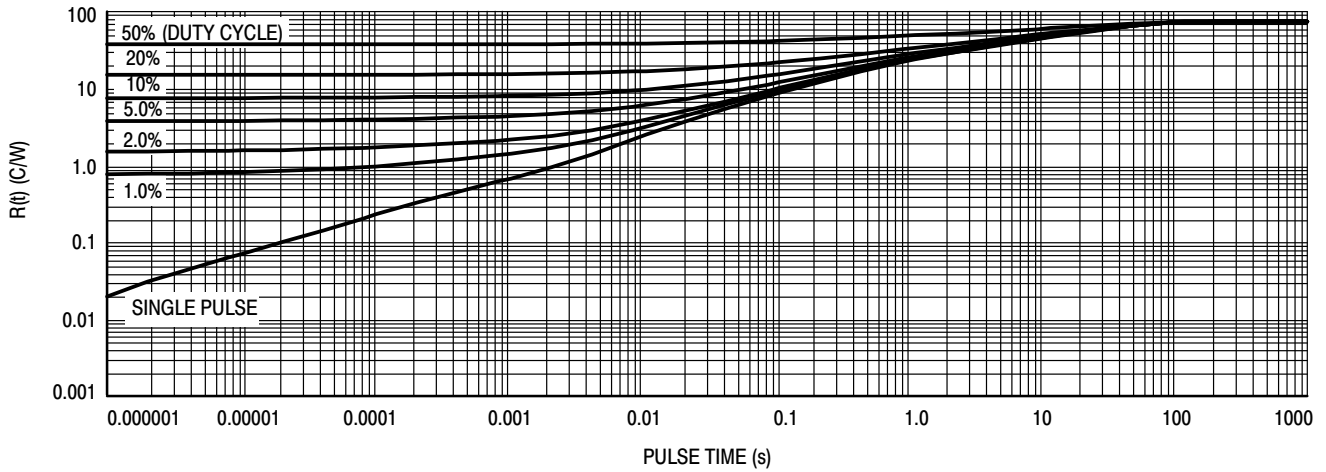

Figure 11. Thermal Response, Junction-to-Ambient (1 inch pad) – MBRA2H100T3G/NRVBA2H100T3G

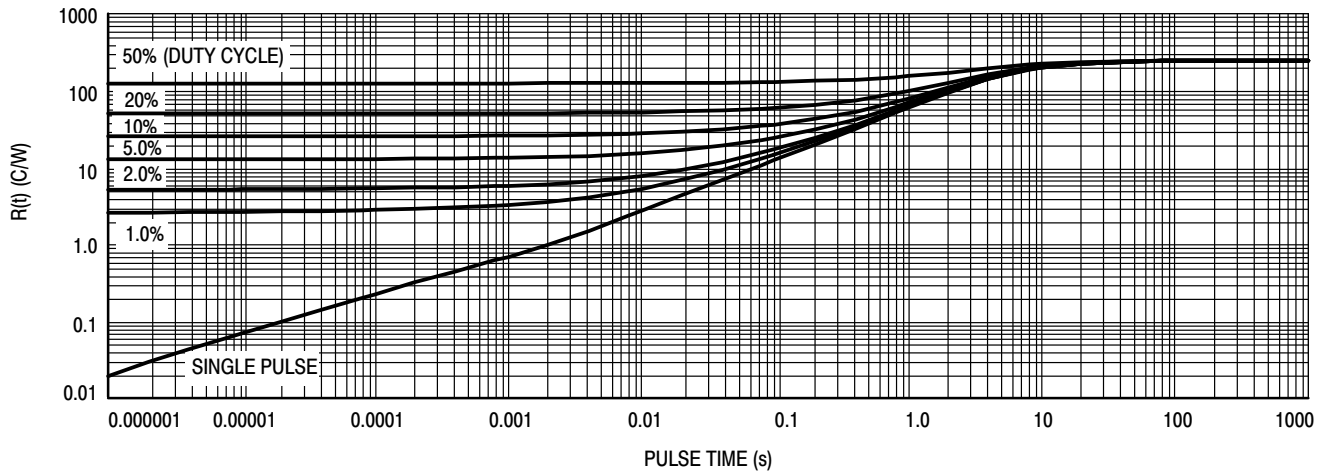

Figure 12. Thermal Response, Junction-to-Ambient (min pad) – MBRA2H100T3G/NRVBA2H100T3G

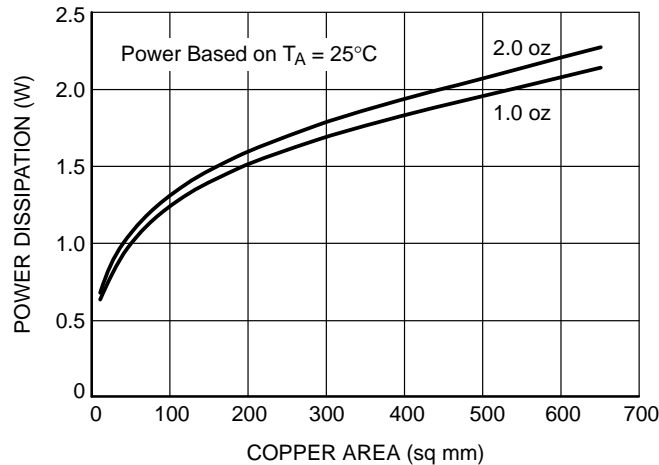
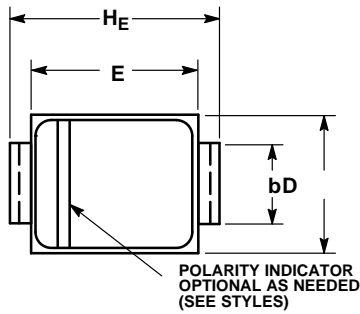

Figure 13. P_D , Junction-to-Ambient (URS copper area)

MBRS2H100T3G, NBR2H100T3G, MBRA2H100T3G, NRVBA2H100T3G

PACKAGE DIMENSIONS

SMA
CASE 403D
ISSUE H



NOTES:

1. DIMENSIONING AND TOLERANCING PER ANSI Y14.5M, 1982.
2. CONTROLLING DIMENSION: INCH.
3. DIMENSION b SHALL BE MEASURED WITHIN DIMENSION L.

DIM	MILLIMETERS			INCHES		
	MIN	NOM	MAX	MIN	NOM	MAX
A	1.97	2.10	2.20	0.078	0.083	0.087
A1	0.05	0.10	0.20	0.002	0.004	0.008
b	1.27	1.45	1.63	0.050	0.057	0.064
c	0.15	0.28	0.41	0.006	0.011	0.016
D	2.29	2.60	2.92	0.090	0.103	0.115
E	4.06	4.32	4.57	0.160	0.170	0.180
HE	4.83	5.21	5.59	0.190	0.205	0.220
L	0.76	1.14	1.52	0.030	0.045	0.060

STYLE 1:

- PIN 1. CATHODE (POLARITY BAND)
- ANODE

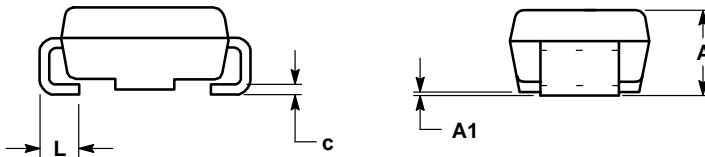

SOLDERING FOOTPRINT*

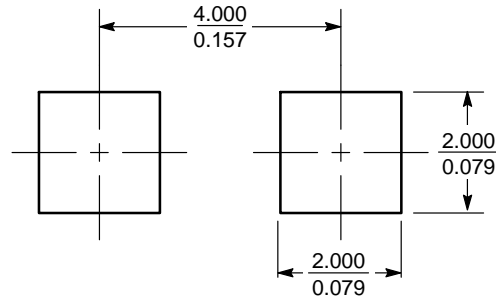

SCALE 8:1 $\left(\frac{\text{mm}}{\text{inches}}\right)$

*For additional information on our Pb-Free strategy and soldering details, please download the ON Semiconductor Soldering and Mounting Techniques Reference Manual, SOLDERRM/D.

MBRS2H100T3G, NBR2H100T3G, MBRA2H100T3G, NRVBA2H100T3G

PACKAGE DIMENSIONS

SMB CASE 403A-03 ISSUE J

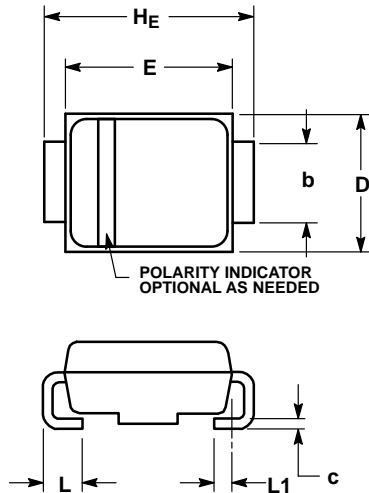

NOTES:

1. DIMENSIONING AND TOLERANCING PER ANSI Y14.5M, 1982.
2. CONTROLLING DIMENSION: INCH.
3. DIMENSION b SHALL BE MEASURED WITHIN DIMENSION L1.

DIM	MILLIMETERS			INCHES		
	MIN	NOM	MAX	MIN	NOM	MAX
A	1.95	2.30	2.47	0.077	0.091	0.097
A1	0.05	0.10	0.20	0.002	0.004	0.008
b	1.96	2.03	2.20	0.077	0.080	0.087
c	0.15	0.23	0.31	0.006	0.009	0.012
D	3.30	3.56	3.95	0.130	0.140	0.156
E	4.06	4.32	4.60	0.160	0.170	0.181
HE	5.21	5.44	5.60	0.205	0.214	0.220
L	0.76	1.02	1.60	0.030	0.040	0.063
L1	0.51 REF			0.020 REF		

SOLDERING FOOTPRINT*

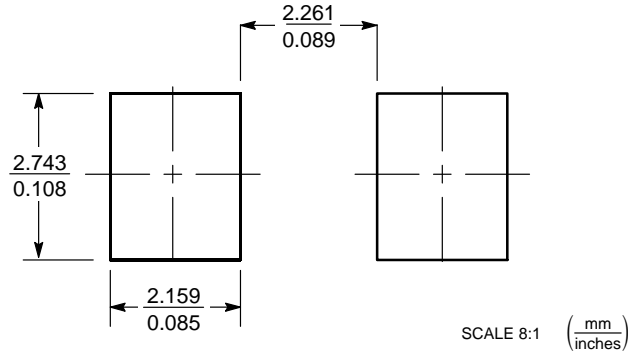

*For additional information on our Pb-Free strategy and soldering details, please download the ON Semiconductor Soldering and Mounting Techniques Reference Manual, SOLDERRM/D.

ON Semiconductor and are trademarks of Semiconductor Components Industries, LLC dba ON Semiconductor or its subsidiaries in the United States and/or other countries. ON Semiconductor owns the rights to a number of patents, trademarks, copyrights, trade secrets, and other intellectual property. A listing of ON Semiconductor's product/patent coverage may be accessed at www.onsemi.com/site/pdf/Patent-Marking.pdf. ON Semiconductor reserves the right to make changes without further notice to any products herein. ON Semiconductor makes no warranty, representation or guarantee regarding the suitability of its products for any particular purpose, nor does ON Semiconductor assume any liability arising out of the application or use of any product or circuit, and specifically disclaims any and all liability, including without limitation special, consequential or incidental damages. Buyer is responsible for its products and applications using ON Semiconductor products, including compliance with all laws, regulations and safety requirements or standards, regardless of any support or applications information provided by ON Semiconductor. "Typical" parameters which may be provided in ON Semiconductor data sheets and/or specifications can and do vary in different applications and actual performance may vary over time. All operating parameters, including "Typicals" must be validated for each customer application by customer's technical experts. ON Semiconductor does not convey any license under its patent rights nor the rights of others. ON Semiconductor products are not designed, intended, or authorized for use as a critical component in life support systems or any FDA Class 3 medical devices or medical devices with a same or similar classification in a foreign jurisdiction or any devices intended for implantation in the human body. Should Buyer purchase or use ON Semiconductor products for any such unintended or unauthorized application, Buyer shall indemnify and hold ON Semiconductor and its officers, employees, subsidiaries, affiliates, and distributors harmless against all claims, costs, damages, and expenses, and reasonable attorney fees arising out of, directly or indirectly, any claim of personal injury or death associated with such unintended or unauthorized use, even if such claim alleges that ON Semiconductor was negligent regarding the design or manufacture of the part. ON Semiconductor is an Equal Opportunity/Affirmative Action Employer. This literature is subject to all applicable copyright laws and is not for resale in any manner.

PUBLICATION ORDERING INFORMATION

LITERATURE FULFILLMENT:

Literature Distribution Center for ON Semiconductor
19521 E. 32nd Pkwy, Aurora, Colorado 80011 USA
Phone: 303-675-2175 or 800-344-3860 Toll Free USA/Canada
Fax: 303-675-2176 or 800-344-3867 Toll Free USA/Canada
Email: orderlit@onsemi.com

N. American Technical Support: 800-282-9855 Toll Free
USA/Canada
Europe, Middle East and Africa Technical Support:
Phone: 421 33 790 2910

ON Semiconductor Website: www.onsemi.com

Order Literature: <http://www.onsemi.com/orderlit>

For additional information, please contact your local Sales Representative

Mouser Electronics

Authorized Distributor

Click to View Pricing, Inventory, Delivery & Lifecycle Information:

[ON Semiconductor:](#)

[NRVBA2H100T3G](#)