

**SURFACE MOUNT GLASS PASSIVATED  
FAST RECOVERY SILICON RECTIFIER**  
**VOLTAGE RANGE 50 to 1000 Volts CURRENT 1.0 Ampere**

**FEATURES**

- \* Glass passivated device
- \* Ideal for surface mounted applications
- \* Low leakage current
- \* Metallurgically bonded construction
- \* Mounting position: Any
- \* Weight: 0.057 gram

**MECHANICAL DATA**

- \* Epoxy : Device has UL flammability classification 94V-0

**MAXIMUM RATINGS AND ELECTRICAL CHARACTERISTICS**

Ratings at 25 °C ambient temperature unless otherwise specified.  
Single phase, half wave, 60 Hz, resistive or inductive load.  
For capacitive load, derate current by 20%.



**DO-214AC**

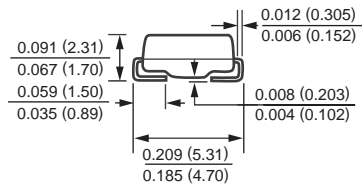
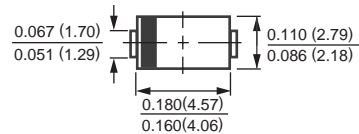

Dimensions in inches and (millimeters)

**MAXIMUM RATINGS** (At TA = 25°C unless otherwise noted)

RATINGS	SYMBOL	FFM101	FFM102	FFM103	FFM104	FFM105	FFM106	FFM107	UNITS
Maximum Recurrent Peak Reverse Voltage	VRRM	50	100	200	400	600	800	1000	Volts
Maximum RMS Voltage	VRMS	35	70	140	280	420	560	700	Volts
Maximum DC Blocking Voltage	Vdc	50	100	200	400	600	800	1000	Volts
Maximum Average Forward Rectified Current at TA = 55°C	Io	1.0							Amps
Peak Forward Surge Current 8.3 ms single half sine-wave superimposed on rated load (JEDEC method)	IFSM	30							Amps
Maximum Thermal Resistance	(Note 2) RθJL	30							°C/W
	(Note 3) RθJA	70							°C/W
Typical Junction Capacitance (Note 1)	CJ	15							pF
Operating and Storage Temperature Range	TJ, TSTG	-55 to + 150							°C

**ELECTRICAL CHARACTERISTICS** (At TA = 25°C unless otherwise noted)

CHARACTERISTICS	SYMBOL	FFM101	FFM102	FFM103	FFM104	FFM105	FFM106	FFM107	UNITS
Maximum Forward Voltage at 1.0A DC	VF	1.3							Volts
Maximum Full Load Reverse Current, Full cycle Average at TA=25°C	IR	50							uAmps
Maximum DC Reverse Current at @TA = 25°C		5.0							uAmps
Rated DC Blocking Voltage @TA = 125°C		100							uAmps
Maximum Reverse Recovery Time (Note 4)	trr	150			250		500		nSec

- NOTES : 1. Measured at 1.0 MHz and applied average voltage of 4.0VDC  
 2. Thermal resistance junction to terminal 6.0mm<sup>2</sup> copper pads to each terminal.  
 3. Thermal resistance junction to ambient, 6.0mm<sup>2</sup> copper pads to each terminal.  
 4. Test Conditions: IF = 0.5A, IR = -1.0A, IRR = -0.25A

# RATING AND CHARACTERISTIC CURVES ( FFM101 THRU FFM107 )

FIG. 1 - TYPICAL FORWARD CURRENT DERATING CURVE

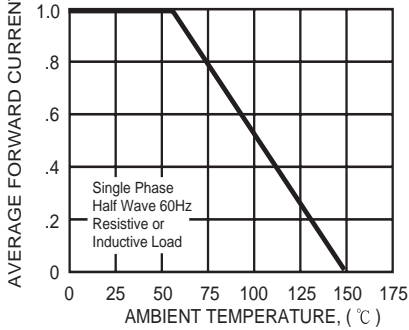

FIG. 2 - MAXIMUM NON-REPETITIVE FORWARD SURGE CURRENT

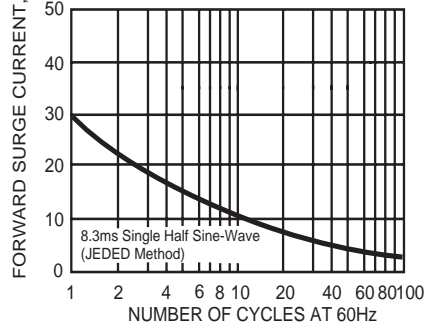

FIG. 3 - TYPICAL REVERSE CHARACTERISTICS

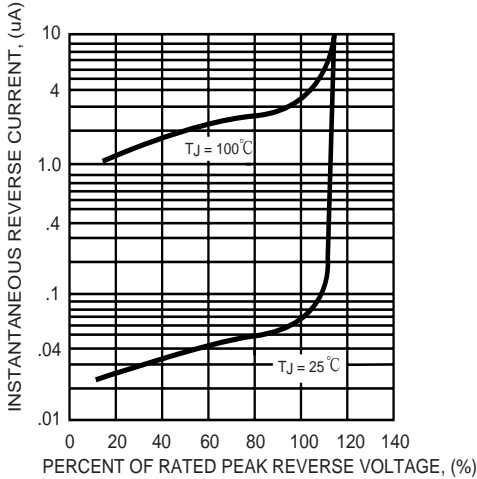

FIG. 4 - TYPICAL INSTANTANEOUS FORWARD CHARACTERISTICS

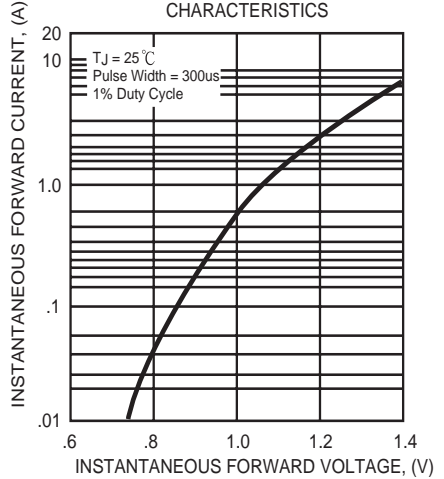

FIG. 5 - TEST CIRCUIT DIAGRAM AND REVERSE RECOVERY TIME CHARACTERISTIC

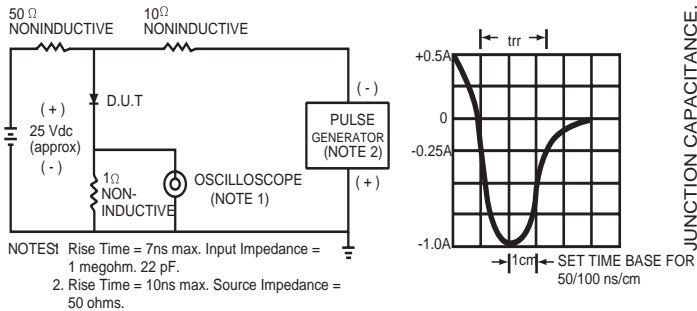
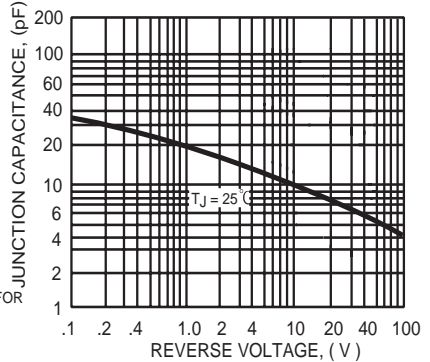
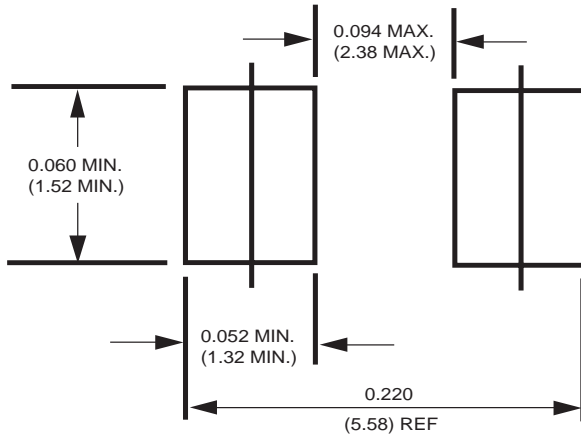

FIG. 6 - TYPICAL JUNCTION CAPACITANCE



## Mounting Pad Layout



Dimensions in inches and (millimeters)

# Mouser Electronics

Authorized Distributor

Click to View Pricing, Inventory, Delivery & Lifecycle Information:

[Rectron:](#)

[FFM106-W](#) [FFM102-W](#) [FFM101-W](#) [FFM104-W](#) [FFM107-W](#) [FFM105-W](#) [FFM103-W](#) [FFM101](#) [FFM102](#) [FFM103](#)  
[FFM104](#) [FFM105](#) [FFM106](#)