



# 120×120×25 mm

San Ace 120 9GV type

## General Specifications

- Material ..... Frame: Plastic (Flammability: UL 94V-0), Impeller: Plastic (Flammability: UL 94V-1)
- Expected life ..... See the table below. (L10 life: 90% survival rate for continuous operation in free air at 60°C, rated voltage)
- Motor protection function ..... Locked rotor burnout protection, Reverse polarity protection  
For details, please refer to p. 547.
- Dielectric strength ..... 50/60 Hz, 500 VAC, for 1 minute (between lead wire conductors and frame)
- Insulation resistance ..... 10 MΩ or more with a 500 VDC megger (between lead wire conductors and frame)
- Sound pressure level (SPL) ..... At 1 m away from the air inlet
- Storage temperature ..... -30 to +70°C (Non-condensing)
- Lead wire ..... ⊕Red ⊖Black Sensor Yellow Control Brown
- Mass ..... 260 g

## Specifications

The models listed below **have ribs and pulse sensors with PWM control function.** For models without ribs, append "1" to the end of model numbers.

Model no.	Rated voltage [V]	Operating voltage range [V]	PWM duty cycle* [%]	Rated current [A]	Rated input [W]	Rated speed [min <sup>-1</sup> ]	Max. airflow [m <sup>3</sup> /min] [CFM]	Max. static pressure [Pa] [inchH <sub>2</sub> O]	SPL [dB (A)]	Operating temperature [°C]	Expected life [h]
9GV1212P4G01	12	10.2 to 13.8	100	1.68	20.16	5100	4.83 171	224 0.9	58	-20 to +70	40000/60°C
			0	0.18	2.16	1650	1.56 55.1	23.5 0.09	30		
9GV1224P4G01	24	20.4 to 27.6	100	0.84	20.16	5100	4.83 171	224 0.9	58		
			0	0.13	3.12	1650	1.56 55.1	23.5 0.09	30		
9GV1248P4J01	48	40.8 to 55.2	100	0.5	24.0	5400	5.11 180	251 1.01	59		
			0	0.15	7.2	3000	2.84 100	77.5 0.31	47		
9GV1248P4G01	48	40.8 to 60.0	100	0.42	20.16	5100	4.83 171	224 0.9	58		
			0	0.07	3.36	1650	1.56 55.1	23.5 0.09	30		
9GV1248P4H01	48	40.8 to 60.0	100	0.33	15.84	4600	4.35 154	182 0.73	55		
			0	0.07	3.36	1650	1.56 55.1	23.5 0.09	30		

\* PWM frequency: 25 kHz

The following sensor and control options are available for selection.

Differs according to the model. Refer to the table on p. 575. Without sensor Pulse sensor Lock sensor

## Airflow - Static Pressure Characteristics / PWM Duty - Speed Characteristics Example

**9GV1212P4G01** With pulse sensor with PWM control function

PWM duty cycle

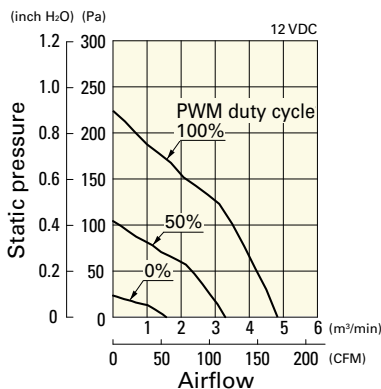

Operating voltage range

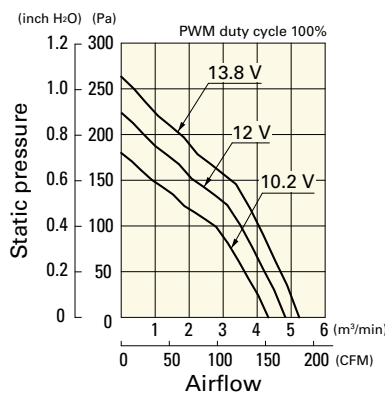

PWM duty - Speed characteristics example

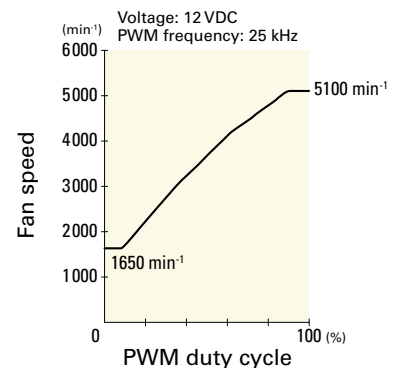

# Airflow - Static Pressure Characteristics / PWM Duty - Speed Characteristics Example

## 9GV1224P4G01 With pulse sensor with PWM control function

PWM duty cycle

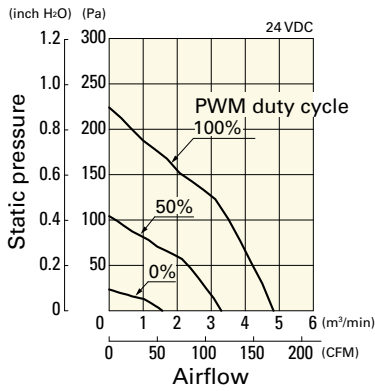

Operating voltage range

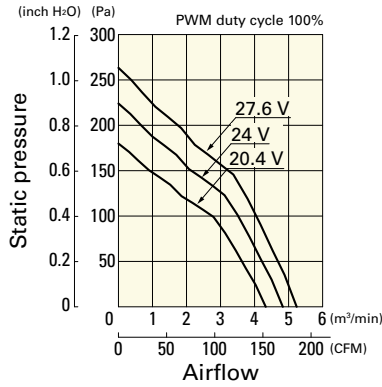

PWM duty - Speed characteristics example

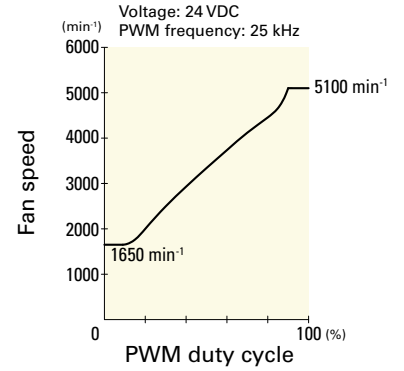

## 9GV1248P4J01 With pulse sensor with PWM control function

PWM duty cycle

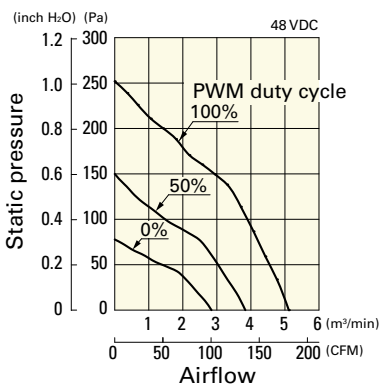

Operating voltage range

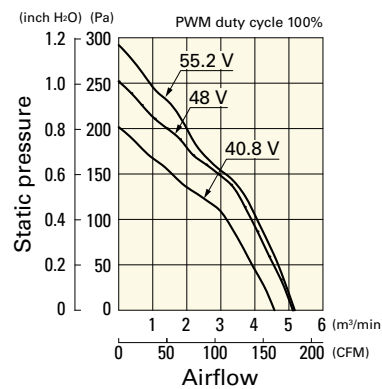

PWM duty - Speed characteristics example

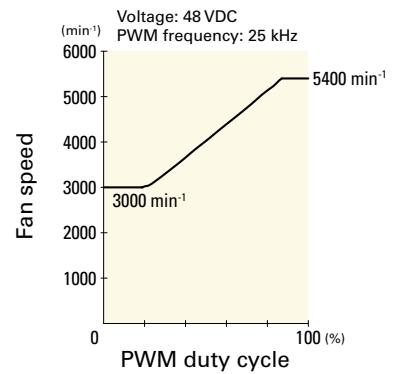

## 9GV1248P4G01 With pulse sensor with PWM control function

PWM duty cycle

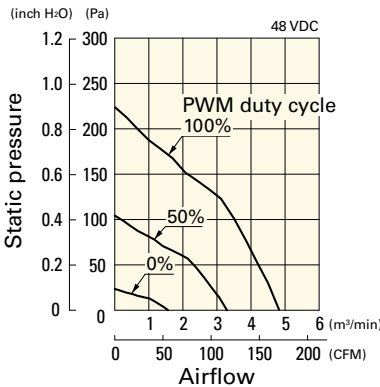

Operating voltage range

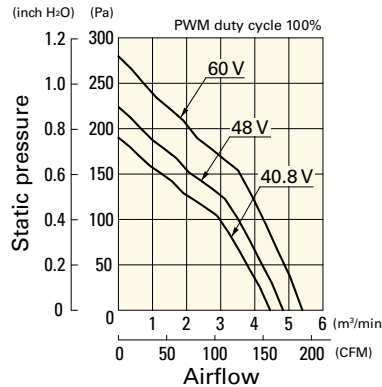

PWM duty - Speed characteristics example

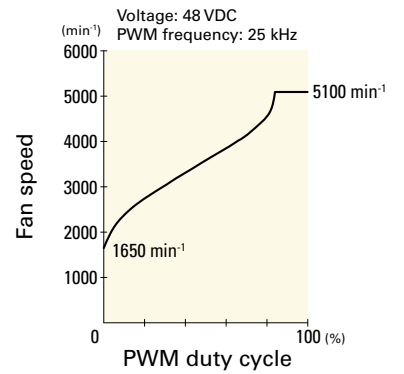

## 9GV1248P4H01 With pulse sensor with PWM control function

PWM duty cycle

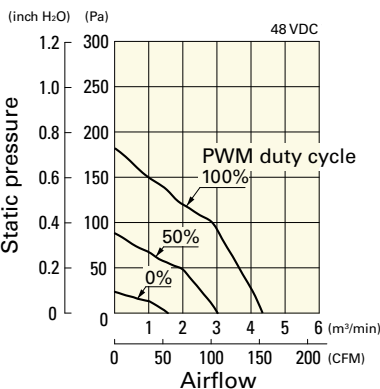

Operating voltage range

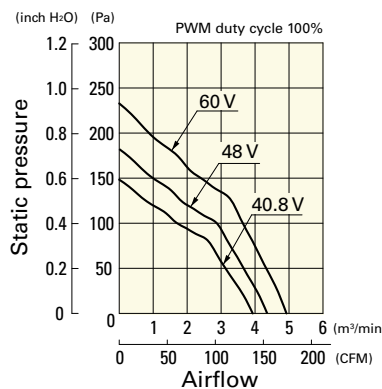

PWM duty - Speed characteristics example

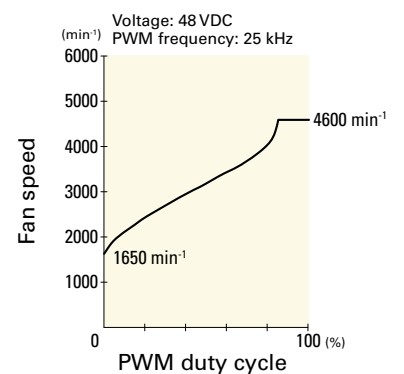

**Dimensions (unit: mm)** (With ribs)

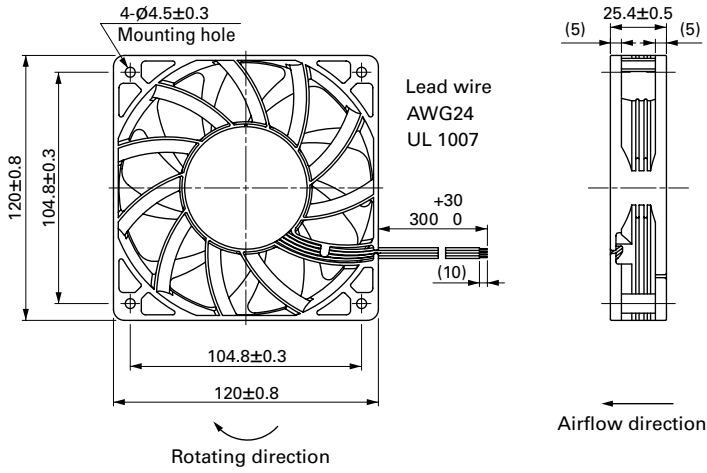

**Reference Dimensions of Mounting Holes and Vent Opening (unit: mm)**

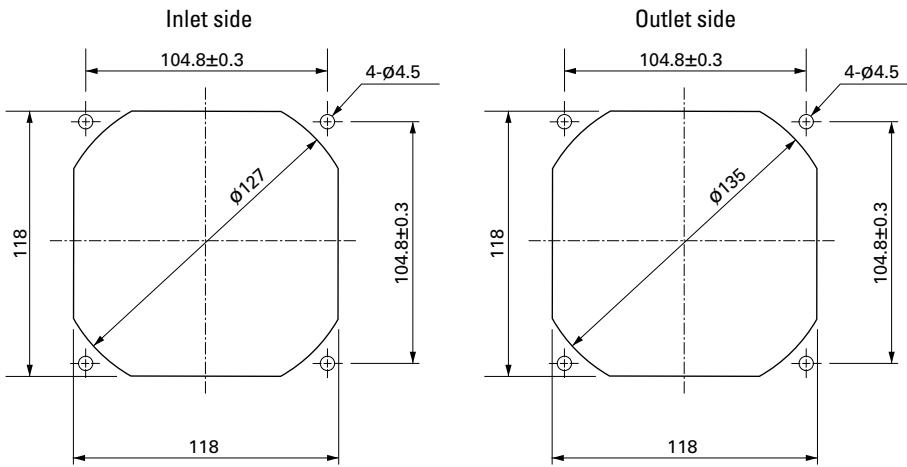

**Options**

**Finger guards**

page: p. 533

Model no.: 109-019E, 109-019K, 109-019C, 109-019H

**Resin finger guards**

page: p. 539

Model no.: 109-1000G

**Resin filter kits**

page: p. 540

Model no.: 109-1000F13 (13PPI), 109-1000F20 (20PPI),  
109-1000F30 (30PPI), 109-1000F40 (40PPI)

# Mouser Electronics

Authorized Distributor

Click to View Pricing, Inventory, Delivery & Lifecycle Information:

## Sanyo Denki:

[9GV1212P4G011](#) [9GV1224P4G01](#) [9GV1248P4H01](#) [9GV1212P4G01](#) [9GV1248P4G01](#) [9GV1248P4J011](#)  
[9GV1248P4J01](#) [9GV1248P4G011](#) [9GV1224G401](#) [9GV1248H401](#) [9GV1248H402](#) [9GV1224G402](#) [9GV1248G4011](#)  
[9GV1212G401](#) [9GV1212G4D01](#) [9GV1224G4D01](#) [9GV1248G401](#) [9GV1212G4011](#) [9GV1212G4021](#) [9GV1248G402](#)  
[9GV1212G402](#) [9GV1224P4G011](#) [9GV1248P4H011](#) [9GV1224G4021](#) [9GV1248H4D01](#)