

## MICRO SWITCH Global Limit Switches

GLA Series

002408

Issue 4

Datasheet



### DESCRIPTION

Honeywell's MICRO SWITCH GLA Limit Switch Series is designed to global EN50041 standards and well suited for worldwide applications. The modular design (heads/actuators, bodies, and contact blocks) of the limit switch allows for rapid response to meet customer applications. The rugged die-cast metal housing of the switch is ideal for indoor and outdoor applications where a degree of IP or NEMA enclosure sealing is required. Normally closed snap-action contacts and normally closed slow-action contacts are positive opening (→).

### DIFFERENTIATION

- Side rotary actuator incorporates dual bearing design which prevents side loading during operation
- Removable contact block allows for ease of wiring
- Modular design of limit switch (heads/actuators, bodies, and contact blocks) allows for rapid customization and delivery
- Optional 1 LED or 2 LED pilot lights in limit switch front cover to indicate voltage present to switch and/or switch actuated
- Specialty contact options, sequential (2-step style) action, and center neutral action

### PORTFOLIO

The GLA Limit Switch Series with standard or plug-in housings (EN50041 design, with 30 mm x 60 mm mounting) complement the smaller GLC Series, GLD Series and GLE Series (EN50047 design, with 20 mm to 22 mm mounting).

The GLA Series is part of the MICRO SWITCH Limit Switch Series that includes the [HDLS Series \(Heavy Duty Limit Switch\)](#) and [General Purpose Limit Switch \(LS\) Series](#).

### FEATURES

- Designed to EN50041 standard, 30 mm x 60 mm mounting
- Available as a standard body or plug-in body with same footprint
- Wide range of actuator heads and levers
- Side rotary switches factory set for CW and CCW actuation; field adjustable for CW only or CCW only
- Certified for global applications; UL/CSA (Americas/Canada), CE (Europe), CCC (Asia-Pacific)<sup>1</sup>
- Conforms to IEC/EN 60947-5-1, EN45545-2 (GLA/GLF Series)
- Sealed to IP67 and NEMA/UL 1, 4, 12, and 13
- Operating temperatures as low as -40 °C to 85 °C [-40 °F to 185 °F]
- Multiple connectivity options to meet most applications: four different threaded conduits, micro-change connectors, mini-change connectors, Deutsch style 4-pin connector
- One or two LED indicators available in switch body
- Single pole double throw, two pole single throw contact blocks (1NC/1NO, 2NC, 2NO) are galvanically (electrically) isolated (Zb) and designed with bifurcated contacts
- Two pole double throw contact block (2NC/2NO) has each pole galvanically (electrically) isolated (Zb)
- Normally closed contacts are positive opening (→), except center neutral style
- Contact blocks are available as snap action or slow action
- Analog output available with side rotary actuator
- Mechanical life up to 15 million operations

### POTENTIAL APPLICATIONS

- Aerial lifts, boom lifts
- Automotive assembly lines and machining centers
- Agriculture equipment
- Conveyors
- Doors and apertures
- Material handling
- Machine tools
- Railroad locomotives and railroad signaling equipment
- Transportation hubs
- Valves

### VALUE TO CUSTOMERS

- Easy to install and maintain
- Rugged metal construction

<sup>1</sup>CCC certification is not available on the GL Series Switches sold within Europe, Middle East, and Africa. Option for CCC certification in these regions is available upon request.

# MICRO SWITCH Global Limit Switches, GLA Series

**Table 1. Specifications**

| Characteristic   | Parameter  |
|--|--|
| Description  | EN50041 industrial grade limit switch, standard body or plug-in body with 30 mm x 60 mm mounting   |
| Certifications   | CE, CCC <sup>1</sup> , CSA, UL   |
| Conforming to standards                                  | IEC/EN 60947-5-1, EN45545-2 (GLA/GLF Series)   |
| Housing material   | Electrostatic epoxy coated zinc  |
| Actuators  | Side rotary, top pin plunger, top adjustable plunger, top roller plunger, top roller lever, wobble stick (multi-directional) actuator, cat whisker (multi-directional) actuator        |
| Termination  | 0.5-14 NPT; PG 13,5; M20; G 1/2 (PF 1/2); Deutsch style 4-pin connector; Micro-change connector; Mini-change connector; Pre-cabled   |
| Contact options*   | 1NC/1NO, 2NC, 2NO, 2NC/2NO, 2NC/2NO sequential, 2NC/2NO center neutral   |
| Contact type   | Snap action, slow action break-before-make (BBM), slow action make-before-break (MBB), slow action   |
| Contact material   | Silver alloy (standard), gold-plated (low-energy applications)   |
| Utilization category                                     | ac15, A300/A600; dc13, Q300  |
| Rated operational voltage (Ue)                           | 240 Vac, 600 Vac, 250 Vdc  |
| Rated operational current (Ie)                           | 3 A, 1.2 A, 0.27 A   |
| Thermal current (Ith)                                    | 10 A, 2.5 A  |
| Rated insulation voltage (Ui)                            | 300 V; 600 V   |
| Rated impulse withstand voltage (Uimp)                   | 2500 V   |
| Short circuit protective device (SCPD), type, and rating | Class J fuse, rated 10A, 600 V   |
| Pollution degree   | 3  |
| Sealing  | IP67; NEMA/UL 1, 4, 12, and 13   |
| Operating temperature                                    | -40 °C to 85 °C [-40 °C to 185 °F] side rotary actuator<br>-25 °C to 85 °C [-13 °F to 185 °F] other actuators  |
| Mechanical life  | Up to 15 million operations  |
| Vibration (actuator not fitted)                          | 10 g conforming to IEC 68-2-6  |
| Shock (actuator not fitted)                              | 50 g conforming to IEC 68-2-27   |
| Options  | Standard limit switch with 1 LED pilot light (GLF Series) or 2 LED pilot lights (GLH Series) in front cover<br>Plug-in limit switch with 1 LED pilot light (GLG Series) in front cover |

\*Normally closed (NC) contacts are positive opening except for the center neutral limit switches

<sup>1</sup>CCC certification is not available on the GL Series Switches sold within Europe, Middle East, and Africa. Option for CCC certification in these regions is available upon request.

**Table 2. Electrical Ratings**

| Electrical Rating |                |                 |                |                                    |
|-------------------|----------------|-----------------|----------------|------------------------------------|
| ac                |                | dc              |                | Gold-plated contacts               |
| A600 Ue (Volts)   | AC15 Ie (Amps) | Q300 Ue (Volts) | DC13 Ie (Amps) |                                    |
| 120               | 6              | 24              | 2.8            | 1 V 10 μA min.<br>50 V 100 mA max. |
| 240               | 3              | 125             | 0.55           |                                    |
| 380               | 1.9            | 250             | 0.27           |                                    |
| 480               | 1.5            |                 |                |                                    |
| 500               | 1.4            |                 |                |                                    |
| 600               | 1.2            |                 |                |                                    |

# MICRO SWITCH Global Limit Switches, GLA Series

Figure 1. Product Nomenclature







| GL                                   | A  | A                       | 01   | A  | E7B   |   |   |  |   |
|--------------------------------------|--|-------------------------|--|--|---|---|---|--|---|
| Switch Type                          | Body Style (EN50041)                         | Conduit                 | Basic Switch   |  | Heads   | Actuators or Levers*                                    |   |  |   |
| <b>GL Series Global Limit Switch</b> | <b>A</b> Non plug-in                         | <b>A</b> 0.5-14 NPT     | <b>01</b> 1NC/1NO, SPDT snap action                      | <b>20</b> 2NC/2NO, DPDT snap action                                      | <b>A</b> Side rotary                              | <b>1A</b> 38 mm fixed, 19 x 6 nylon roller              | <b>3</b> 38 mm fixed yoke, no rollers             | <b>7A</b> 150 mm x Ø6.4 mm plastic rod       | <b>1</b> CW actuation only                            |
|                                      | <b>B</b> Plug-in                             | <b>B</b> PG 13,5        | <b>07</b> 1NC/1NO, SPDT, gold contacts, snap action      | <b>22</b> 2NC/2NO, DPDT, gold contacts, snap action                      | <b>J</b> Side rotary, center neutral              | <b>1B</b> 38 mm fixed, 19 x 6 steel roller              | <b>3A</b> 38 mm fixed yoke, 19 x 6 nylon rollers  | <b>7B</b> 141 mm x Ø6.7 mm coil spring       | <b>2</b> CCW actuation only                           |
|                                      | <b>F</b> Non plug-in with 1 LED pilot light  | <b>C</b> 20 mm          | <b>02</b> 1NC/1NO, SPDT snap action**                    | <b>24</b> 2NC/2NO, DPDT snap action, LED                                 | <b>B</b> Top pin plunger (SST)                    | <b>1C</b> 38 mm fixed, 25 x 12 nylon roller             | <b>3B</b> 38 mm fixed yoke, 19 x 6 steel rollers  | <b>7C</b> 153 mm x Ø4.7 mm steel coil spring | <b>3</b> Head with lever to right                     |
|                                      | <b>G</b> Plug-in with 1 LED pilot light      | <b>D</b> G 1/2 (PF 1/2) | <b>12</b> 1NC/1NO, SPDT snap action, 1 LED**             | <b>32</b> 2NC/2NO, DPDT, snap action, gold contacts, LED                 | <b>C</b> Top roller plunger, SST 12 x 5 mm roller | <b>1T</b> 38 mm fixed, 19 x 9 SST roller                | <b>4J</b> Adjustable aluminum rod, 200 mm max.    | <b>7D</b> 165 mm x Ø1.3 mm SST wire          | <b>4</b> Head with lever to left                      |
|                                      | <b>H</b> Non plug-in with 2 LED pilot lights |                         | <b>03</b> 1NC/1NO, SPDT, BBM, slow action                | <b>21</b> 2NC/2NO, DPDT, snap action, sequential                         | <b>D</b> Top roller lever, nylon 19 x 8 mm roller | <b>1Y</b> 38 mm fixed, 50 x 10 rubber roller            | <b>4K</b> Adjustable aluminum rod, 140 mm max.    | <b>8A</b> 140 mm x Ø1.2 mm SST wire          | <b>5</b> Head with lever to mounting surface          |
|                                      |  |                         | <b>33</b> 1NC/1NO, SPDT, BBM, slow action, gold contacts | <b>28</b> 2NC/2NO, DPDT, snap action, gold contacts, sequential          | <b>H</b> Top adjustable plunger                   | <b>2A</b> 38 to 93 mm adjustable, 19 x 6 nylon roller   | <b>4N</b> Adjustable SST rod, 318 mm max.         | <b>8B</b> 190 mm x Ø1.2 mm SST wire          | <b>6</b> Roller plunger perpendicular to mtg. surface |
|                                      |  |                         | <b>04</b> 1NC/1NO, SPDT, MBB, slow action                | <b>25</b> 2NC/2NO, DPDT, snap action, LED, sequential                    | <b>E</b> Wobble stick                             | <b>2B</b> 38 to 93 mm adjustable, 19 x 6 steel roller   | <b>5A</b> 38 mm fixed offset, 19 x 6 nylon roller | <b>8C</b> 141 mm x Ø6.7 mm SST coil spring   |   |
|                                      |  |                         | <b>34</b> 1NC/1NO, SPDT, MBB, slow action, gold contacts | <b>31</b> 2NC/2NO, DPDT, snap action, gold contacts, LED, sequential     | <b>K</b> Cat whisker                              | <b>2D</b> 38 to 93 mm adjustable, 38 x 5 nylon roller   | <b>5B</b> 38 mm fixed offset, 19 x 6 steel roller |  |   |
|                                      |  |                         | <b>05</b> 2NO, slow action                               | <b>26</b> 2NC/2NO, DPDT, snap action, center neutral                     |   | <b>2W</b> 38 to 93 mm adjustable, 38 x 12 rubber roller |   |  |   |
|                                      |  |                         | <b>35</b> 2NO, slow action, gold contacts                | <b>29</b> 2NC/2NO, DPDT, snap action, center neutral                     |   | <b>2Y</b> 38 to 93 mm adjustable, 50 x 10 rubber roller |   |  |   |
|                                      |  |                         | <b>06</b> 2NC, slow action                               | <b>27</b> 2NC/2NO, DPDT, snap action, LED, center neutral                |   |   |   |  |   |
|                                      |  |                         | <b>36</b> 2NC, slow action, gold contacts                | <b>30</b> 2NC/2NO, DPDT, snap action, LED, center neutral, gold contacts |   |   |   |  |   |

\*\*NOTE: Basic switch codes **02** and **12** may only be used with body styles **B** and **G**.

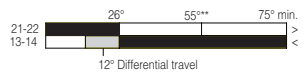
\* Levers beginning with codes 1 to 5 are for **A** and **J** style side rotary heads only. Actuators beginning with Code 7 are for **E** style wobble stick head only. Actuators beginning with Code 8 are for **K** style cat whisker head only.

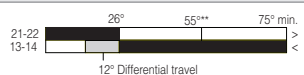
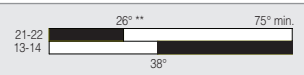
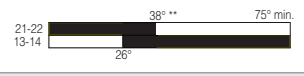
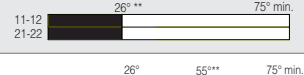
# MICRO SWITCH Global Limit Switches, GLA Series

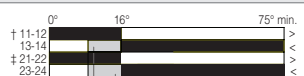
Table 3. MICRO SWITCH GLA Series Side Rotary Order Guide

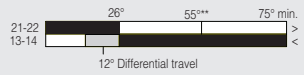
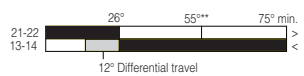
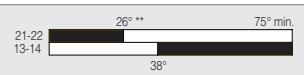
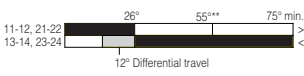
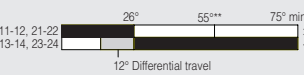
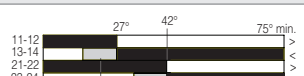
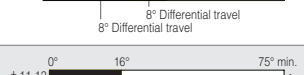
|   |  |                        |                  |                                  |   |  | Catalog Listing*        |               |           |
|---|--|------------------------|------------------|----------------------------------|---|--|-------------------------|---------------|-----------|
| Head and Lever Type   | Contact Arrangement                    | Contact Type           | Contact Material | Operating Torque max. Nm [in-lb] | Bar Chart (degrees)<br>■ contact closed<br>□ contact open | With LED Pilot Light/s   | 0.5-14 NPT Conduit      | 20 mm Conduit |           |
|    | Side rotary, no lever                  | 1NC/1NO                | Snap action      | Silver alloy                     | 0,33 [2.9]  |    | -                       | GLAA01A       | GLAC01A   |
|   |  | 1NC/1NO                | Snap action      | Silver alloy                     | 0,33 [2.9]  |    | 1 LED (yellow)          | GLFA01A       | -         |
|   |  | 1NC/1NO                | Snap action      | Gold-plated                      | 0,33 [2.9]  |    | -                       | GLAA07A       | GLAC07A   |
|   |  | 1NC/1NO                | Slow action, BBM | Silver alloy                     | 0,33 [2.9]  |    | -                       | -             | GLAC03A   |
|   |  | 1NC/1NO                | Slow action, MBB | Silver alloy                     | 0,33 [2.9]  |    | -                       | GLAA04A       | -         |
|   |  | 2NC                    | Slow action      | Silver alloy                     | 0,33 [2.9]  |    | -                       | -             | GLAC06A   |
|   |  | 2NC/2NO                | Snap action      | Silver alloy                     | 0,33 [2.9]  |    | -                       | GLAA20A       | -         |
|   |  | 2NC/2NO Center neutral | Snap action      | Silver alloy                     | 0,33 [2.9]  |   | -                       | GLAA26J       | -         |
|   |  | 2NC/2NO Center neutral | Snap action      | Gold-plated                      | 0,33 [2.9]  |  | -                       | GLAA29J       | -         |
|  | Side rotary, fixed lever, nylon roller | 1NC/1NO                | Snap action      | Silver alloy                     | 0,33 [2.9]  |  | -                       | GLAA01A1A     | GLAC01A1A |
|   |  | 1NC/1NO                | Snap action      | Gold-plated                      | 0,33 [2.9]  |  | 2 LEDs (green & yellow) | GLHA07A1A     | -         |
|   |  | 1NC/1NO                | Slow action, BBM | Silver alloy                     | 0,33 [2.9]  |  | -                       | GLAA03A1A     | -         |
|   |  | 2NC/2NO                | Snap action      | Silver alloy                     | 0,33 [2.9]  |  | -                       | GLAA20A1A     | GLAC20A1A |
|   |  | 2NC/2NO                | Snap action      | Silver alloy                     | 0,33 [2.9]  |  | 2 LEDs (green & yellow) | -             | GLHC24A1A |
|   |  | 2NC/2NO Sequential     | Snap action      | Silver alloy                     | 0,33 [2.9]  |  | -                       | GLAA21A1A     | -         |
|   |  | 2NC/2NO Center neutral | Snap action      | Silver alloy                     | 0,33 [2.9]  |  | -                       | GLAA26J1A     | -         |

\* Note: When conduit style G1/2 (PF1/2) is required, change the 4th digit in the catalog listing to the letter D. For example, GLAA01A1A would change to GLAD01A1A for G1/2 conduit. When conduit style PG13,5 is required, change the 4th digit in the catalog listing to the letter B. For example, GLAA01A1A would change to GLAB01A1A for PG13,5 conduit.

\*\* Positive opening occurs.

† Contacts 11-12, 13-14 operate in CCW direction. ‡ Contacts 21-22, 23-24 operate in CW direction.

# MICRO SWITCH Global Limit Switches, GLA Series

Table 3. MICRO SWITCH GLA Series Side Rotary Order Guide, continued

|  |                        |                  |                  |                                  |  | Catalog Listing*        |                    |                  |  |
|--|------------------------|------------------|------------------|----------------------------------|--|-------------------------|--------------------|------------------|--|
| Head and Lever Type  | Contact Arrangement    | Contact Type     | Contact Material | Operating Torque max. Nm [in-lb] | Bar Chart (degrees)<br>■ contact closed<br>□ contact open                            | With LED Pilot Light/s  | 0.5-14 NPT Conduit | 20 mm Conduit    |  |
|  <p>Side rotary, fixed lever, steel roller</p> | 1NC/1NO                | Snap action      | Silver alloy     | 0,33 [2.9]                       |    | -                       | <b>GLAA01A1B</b>   | <b>GLAC01A1B</b> |  |
|  | 1NC/1NO                | Snap action      | Silver alloy     | 0,33 [2.9]                       |    | 1 LED (yellow)          | <b>GLFA01A1B</b>   | -                |  |
|  | 1NC/1NO                | Snap action      | Silver alloy     | 0,33 [2.9]                       |    | 2 LEDs (green & yellow) | <b>GLHA01A1B</b>   | <b>GLHC01A1B</b> |  |
|  | 1NC/1NO                | Snap action      | Gold-plated      | 0,33 [2.9]                       |    | -                       | <b>GLAA07A1B</b>   | <b>GLAC07A1B</b> |  |
|  | 1NC/1NO                | Slow action, BBM | Silver alloy     | 0,33 [2.9]                       |    | -                       | <b>GLAA03A1B</b>   | -                |  |
|  | 1NC/1NO                | Slow action, MBB | Silver alloy     | 0,33 [2.9]                       |    | -                       | <b>GLAA04A1B</b>   | -                |  |
|  | 2NC                    | Slow action      | Silver alloy     | 0,33 [2.9]                       |   | -                       | <b>GLAA06A1B</b>   | <b>GLAC06A1B</b> |  |
|  | 2NC/2NO                | Snap action      | Silver alloy     | 0,33 [2.9]                       |  | -                       | <b>GLAA20A1B</b>   | <b>GLAC20A1B</b> |  |
|  | 2NC/2NO                | Snap action      | Gold-plated      | 0,33 [2.9]                       |  | -                       | <b>GLAA22A1B</b>   | -                |  |
|  | 2NC/2NO                | Snap action      | Silver alloy     | 0,33 [2.9]                       |  | 1 LED (yellow)          | <b>GLFA24A1B</b>   | -                |  |
|  | 2NC/2NO                | Snap action      | Silver alloy     | 0,33 [2.9]                       |  | 2 LEDs (green & yellow) | -                  | -                |  |
|  | 2NC/2NO                | Snap action      | Gold-plated      | 0,33 [2.9]                       |  | 2 LEDs (green & yellow) | <b>GLHA32A1B</b>   | -                |  |
|  | 2NC/2NO Sequential     | Snap action      | Silver alloy     | 0,33 [2.9]                       |  | -                       | -                  | <b>GLAC21A1B</b> |  |
|  | 2NC/2NO Center neutral | Snap action      | Silver alloy     | 0,33 [2.9]                       |  | -                       | <b>GLAA26J1B</b>   | -                |  |
|  | 2NC/2NO Center neutral | Snap action      | Gold-plated      | 0,33 [2.9]                       |  | -                       | <b>GLAA29J1B</b>   | -                |  |

\* Note: When conduit style G1/2 (PF1/2) is required, change the 4th digit in the catalog listing to the letter D. For example, GLAA01A1A would change to GLAD01A1A for G1/2 conduit. When conduit style PG13,5 is required, change the 4th digit in the catalog listing to the letter B. For example, GLAA01A1A would change to GLAB01A1A for PG13,5 conduit.

\*\* Positive opening occurs.

† Contacts 11-12, 13-14 operate in CCW direction. ‡ Contacts 21-22, 23-24 operate in CW direction.

# MICRO SWITCH Global Limit Switches, GLA Series

Table 3. MICRO SWITCH GLA Series Side Rotary Order Guide, continued

|  |                        |                  |                  |                                  |   |                        | Catalog Listing*   |               |  |
|--|------------------------|------------------|------------------|----------------------------------|---|------------------------|--------------------|---------------|--|
| Head and Lever Type  | Contact Arrangement    | Contact Type     | Contact Material | Operating Torque max. Nm [in-lb] | Bar Chart (degrees)   | With LED Pilot Light/s | 0.5-14 NPT Conduit | 20 mm Conduit |  |
|  <p>Side rotary, adjustable lever, nylon roller</p>   | 1NC/1NO                | Snap action      | Silver alloy     | 0,33 [2.9]                       |    | -                      | GLAA01A2A          | GLAC01A2A     |  |
|  | 1NC/1NO                | Snap action      | Gold-plated      | 0,33 [2.9]                       |    | -                      | GLAA07A2A          | -             |  |
|  | 2NC                    | Slow action      | Silver alloy     | 0,33 [2.9]                       |    | -                      | GLAA06A2A          | -             |  |
|  | 2NC/2NO                | Snap action      | Silver alloy     | 0,33 [2.9]                       |    | -                      | GLAA20A2A          | -             |  |
|  | 2NC/2NO                | Snap action      | Gold-plated      | 0,33 [2.9]                       |    | -                      | GLAA22A2A          | -             |  |
|  | 2NC/2NO                | Snap action      | Silver alloy     | 0,33 [2.9]                       |    | 1 LED (yellow)         | GLFA24A2A          | -             |  |
|  | 2NC/2NO Center neutral | Snap action      | Silver alloy     | 0,33 [2.9]                       |   | -                      | GLAA26J2A          | -             |  |
|  <p>Side rotary, adjustable lever, steel roller</p> | 1NC/1NO                | Snap action      | Silver alloy     | 0,33 [2.9]                       |  | -                      | GLAA01A2B          | GLAC01A2B     |  |
|  | 1NC/1NO                | Snap action      | Gold-plated      | 0,33 [2.9]                       |  | -                      | GLAA07A2B          | GLAC07A2B     |  |
|  | 1NC/1NO                | Snap action      | Silver alloy     | 0,33 [2.9]                       |  | 1 LED (yellow)         | GLFA01A2B          | GLFC01A2B     |  |
|  | 1NC/1NO                | Slow action, BBM | Silver alloy     | 0,33 [2.9]                       |  | -                      | GLAA03A2B          | -             |  |
|  | 1NC/1NO                | Slow action, BBM | Silver alloy     | 0,33 [2.9]                       |  | 1 LED (yellow)         | GLFA03A2B          | -             |  |
|  | 1NC/1NO                | Slow action, BBM | Gold-plated      | 0,33 [2.9]                       |  | 1 LED (yellow)         | GLFA33A2B          | -             |  |
|  | 2NC                    | Slow action      | Silver alloy     | 0,33 [2.9]                       |  | -                      | -                  | GLAC06A2B     |  |
|  | 2NC/2NO                | Snap action      | Silver alloy     | 0,33 [2.9]                       |  | -                      | GLAA20A2B          | GLAC20A2B     |  |
|  | 2NC/2NO Center neutral | Snap action      | Silver alloy     | 0,33 [2.9]                       |  | -                      | GLAA26J2B          | -             |  |

\* Note: When conduit style G1/2 (PF1/2) is required, change the 4th digit in the catalog listing to the letter D. For example, GLAA01A1A would change to GLAD01A1A for G1/2 conduit. When conduit style PG13,5 is required, change the 4th digit in the catalog listing to the letter B. For example, GLAA01A1A would change to GLAB01A1A for PG13,5 conduit.

\*\* Positive opening occurs. † Contacts 11-12, 13-14 operate in CCW direction. ‡ Contacts 21-22, 23-24 operate in CW direction.

# MICRO SWITCH Global Limit Switches, GLA Series

Table 3. MICRO SWITCH GLA Series Side Rotary Order Guide, continued

|   |   |              |                  |                                  |  |  | Catalog Listing*        |               |           |
|---|---|--------------|------------------|----------------------------------|--|--|-------------------------|---------------|-----------|
| Head and Lever Type   | Contact Arrangement   | Contact Type | Contact Material | Operating Torque max. Nm [in-lb] | Bar Chart (degrees)<br>■ contact closed<br>□ contact open                            | With LED Pilot Light/s   | 0.5-14 NPT Conduit      | 20 mm Conduit |           |
|  <p>Side rotary, adjustable lever, Ø 50 mm rubber roller</p> | 1NC/1NO   | Snap action  | Silver alloy     | 0,33 [2.9]                       |    | -  | GLAA01A2Y               | -             |           |
|   |  <p>Side rotary, adjustable aluminum rod</p> | 1NC/1NO      | Snap action      | Silver alloy                     | 0,33 [2.9]   |    | -                       | GLAA01A4J     | GLAC01A4J |
|   |   | 1NC/1NO      | Snap action      | Silver alloy                     | 0,33 [2.9]   |    | 1 LED (yellow)          | -             | GLFC01A4J |
|   |   | 1NC/1NO      | Snap action      | Silver alloy                     | 0,33 [2.9]   |    | 2 LEDs (green & yellow) | GLHA01A4J     | -         |
|   |   | 1NC/1NO      | Slow action, BBM | Silver alloy                     | 0,33 [2.9]   |   | -                       | GLAA03A4J     | -         |
|   |   | 1NC/1NO      | Slow action, MBB | Silver alloy                     | 0,33 [2.9]   |  | -                       | GLAA04A4J     | -         |
|   |   | 2NC/2NO      | Snap action      | Silver alloy                     | 0,33 [2.9]   |  | -                       | GLAA20A4J     | -         |
|   |   | 2NC/2NO      | Snap action      | Gold-plated                      | 0,33 [2.9]   |  | -                       | GLAA22A4J     | -         |
|   |   | 2NC/2NO      | Snap action      | Silver alloy                     | 0,33 [2.9]   |  | 1 LED (yellow)          | GLFA24A4J     | -         |
|   |   | 2NC/2NO      | Snap action      | Gold-plated                      | 0,33 [2.9]   |  | 1 LED (yellow)          | -             | GLFC32A4J |
|   |   | 2NC/2NO      | Snap action      | Silver alloy                     | 0,33 [2.9]   |  | 2 LEDs (green & yellow) | GLHA24A4J     | -         |
| 2NC/2NO Sequential  |   | Snap action  | Silver alloy     | 0,33 [2.9]                       |  | -  | GLAA21A4J               | -             |           |

\* Note: When conduit style G1/2 (PF1/2) is required, change the 4th digit in the catalog listing to the letter D. For example, GLAA01A1A would change to GLAD01A1A for G1/2 conduit. When conduit style PG13,5 is required, change the 4th digit in the catalog listing to the letter B. For example, GLAA01A1A would change to GLAB01A1A for PG13,5 conduit.

\*\* Positive opening occurs.



# MICRO SWITCH Global Limit Switches, GLA Series

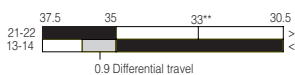

Table 3. MICRO SWITCH GLA Series Side Rotary Order Guide, continued

|   |                     |              |                  |                                     |  |                        | Catalog Listing*   |               |  |
|---|---------------------|--------------|------------------|-------------------------------------|--|------------------------|--------------------|---------------|--|
| Head and Lever Type   | Contact Arrangement | Contact Type | Contact Material | Operating Torque max.<br>Nm [in-lb] | Bar Chart (degrees)  | With LED Pilot Light/s | 0.5-14 NPT Conduit | 20 mm Conduit |  |
|  | 2NC                 | Slow action  | Silver alloy     | 0,33<br>[2.9]                       |  | -                      | <b>GLAA06A5A</b>   | -             |  |
|   | 2NC/2NO             | Snap action  | Silver alloy     | 0,33<br>[2.9]                       |  | -                      | <b>GLAA20A5A</b>   | -             |  |

\* Note: When conduit style G1/2 (PF1/2) is required, change the 4th digit in the catalog listing to the letter D. For example, GLAA01A1A would change to GLAD01A1A for G1/2 conduit. When conduit style PG13,5 is required, change the 4th digit in the catalog listing to the letter B. For example, GLAA01A1A would change to GLAB01A1A for PG13,5 conduit.

\*\* Positive opening occurs.

Table 4. MICRO SWITCH GLA Series Plunger Order Guide

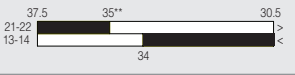
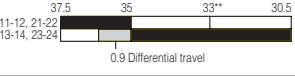
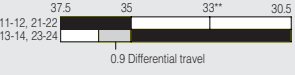
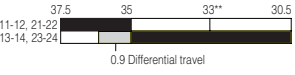
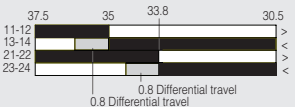
|   |                     |                  |                  |                                |  |                        | Catalog Listing*   |                |  |
|---|---------------------|------------------|------------------|--------------------------------|--|------------------------|--------------------|----------------|--|
| Head Type   | Contact Arrangement | Contact Type     | Contact Material | Operating Force max.<br>N [lb] | Bar Chart (millimeters)  | With LED Pilot Light/s | 0.5-14 NPT Conduit | 20 mm Conduit  |  |
|  | 1NC/1NO             | Snap action      | Silver alloy     | 16<br>[3.6]                    |  | -                      | <b>GLAA01B</b>     | <b>GLAC01B</b> |  |
|   | 1NC/1NO             | Snap action      | Silver alloy     | 16<br>[3.6]                    |  | 1 LED<br>(yellow)      | <b>GLFA01B</b>     | <b>GLFC01B</b> |  |
|   | 1NC/1NO             | Snap action      | Gold-plated      | 16<br>[3.6]                    |  | -                      | -                  | <b>GLAC07B</b> |  |
|   | 1NC/1NO             | Slow action, BBM | Silver alloy     | 16<br>[3.6]                    |  | -                      | <b>GLAA03B</b>     | -              |  |
|   | 2NC/2NO             | Snap action      | Silver alloy     | 16<br>[3.6]                    |  | -                      | <b>GLAA20B</b>     | <b>GLAC20B</b> |  |
|   | 2NC/2NO             | Snap action      | Silver alloy     | 16<br>[3.6]                    |  | 1 LED<br>(yellow)      | <b>GLFA24B</b>     | -              |  |
|   | 2NC/2NO             | Snap action      | Gold-plated      | 16<br>[3.6]                    |  | -                      | <b>GLAA22B</b>     | <b>GLAC22B</b> |  |
|   | 2NC/2NO             | Snap action      | Gold-plated      | 16<br>[3.6]                    |  | 1 LED<br>(yellow)      | <b>GLFA32B</b>     | -              |  |

\* Note: When conduit style G1/2 (PF1/2) is required, change the 4th digit in the catalog listing to the letter D. For example, GLAA01A1A would change to GLAD01A1A for G1/2 conduit. When conduit style PG13,5 is required, change the 4th digit in the catalog listing to the letter B. For example, GLAA01A1A would change to GLAB01A1A for PG13,5 conduit.

\*\* Positive opening occurs.



# MICRO SWITCH Global Limit Switches, GLA Series

Table 5. MICRO SWITCH GLA Series Roller Plunger Order Guide

|  |                     |                  |                  |  |  |                         | Catalog Listing*   |                |  |
|--|---------------------|------------------|------------------|--|--|-------------------------|--------------------|----------------|--|
| Head Type  | Contact Arrangement | Contact Type     | Contact Material | Operating Force max. N [lb]  | Bar Chart (millimeters)<br>■ contact closed<br>□ contact open                        | With LED Pilot Light/s  | 0.5-14 NPT Conduit | 20 mm Conduit  |  |
| <br>Top roller plunger | 1NC/1NO             | Snap action      | Silver alloy     | 16 [3.6]   |    | -                       | <b>GLAA01C</b>     | <b>GLAC01C</b> |  |
|  | 1NC/1NO             | Snap action      | Silver alloy     | 16 [3.6]   |    | 1 LED (yellow)          | <b>GLFA01C</b>     | -              |  |
|  | 1NC/1NO             | Snap action      | Silver alloy     | 16 [3.6]   |    | 2 LEDs (green & yellow) | <b>GLHA01C</b>     | -              |  |
|  | 1NC/1NO             | Snap action      | Gold-plated      | 16 [3.6]   |    | -                       | <b>GLAA07C</b>     | <b>GLAC07C</b> |  |
|  | 1NC/1NO             | Snap action      | Gold-plated      | 16 [3.6]   |    | 1 LED (yellow)          | <b>GLFA07C</b>     | -              |  |
|  | 1NC/1NO             | Slow action, BBM | Silver alloy     | 16 [3.6]   |    | -                       | <b>GLAA03B</b>     | -              |  |
|  | 1NC/1NO             | Slow action, MBB | Silver alloy     | 16 [3.6]   |  | -                       | <b>GLAA04B</b>     | -              |  |
|  | 2NC                 | Slow action      | Silver alloy     | 16 [3.6]   |  | -                       | <b>GLAA06C</b>     | <b>GLAC06C</b> |  |
|  | 2NC/2NO             | Snap action      | Silver alloy     | 16 [3.6]   |  | -                       | <b>GLAA20C</b>     | <b>GLAC20C</b> |  |
|  | 2NC/2NO             | Snap action      | Gold-plated      | 16 [3.6]   |  | -                       | <b>GLAA22C</b>     | -              |  |
|  | 2NC/2NO             | Snap action      | Silver alloy     | 16 [3.6]   |  | 1 LED (yellow)          | <b>GLFA24C</b>     | -              |  |
|  | 2NC/2NO             | Snap action      | Gold-plated      | 16 [3.6]   |  | 2 LEDs (green & yellow) | -                  | <b>GLHC32C</b> |  |
| 2NC/2NO Sequential   | Snap action         | Silver alloy     | 16 [3.6]         |  | -  | <b>GLAA21C</b>          | -                  |                |  |

\* Note: When conduit style G1/2 (PF1/2) is required, change the 4th digit in the catalog listing to the letter D. For example, GLAA01A1A would change to GLAD01A1A for G1/2 conduit. When conduit style PG13,5 is required, change the 4th digit in the catalog listing to the letter B. For example, GLAA01A1A would change to GLAB01A1A for PG13,5 conduit.

\*\* Positive opening occurs.

# MICRO SWITCH Global Limit Switches, GLA Series

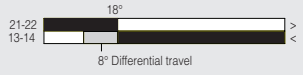

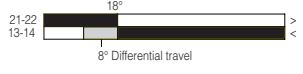

Table 6. MICRO SWITCH GLA Series Wobble Order Guide

|   |                     |                  |                  |                             |  |                         |                    | Catalog Listing* |  |
|---|---------------------|------------------|------------------|-----------------------------|--|-------------------------|--------------------|------------------|--|
| Head Type   | Contact Arrangement | Contact Type     | Contact Material | Operating Force max. N [lb] | Bar Chart (degrees)<br>■ contact closed<br>□ contact open                            | With LED Pilot Light/s  | 0.5-14 NPT Conduit | 20 mm Conduit    |  |
|    | 1NC/1NO             | Snap action      | Silver alloy     | 0,2 [1.8]                   |    | -                       | <b>GLAA01E7A</b>   | -                |  |
|   | 1NC/1NO             | Snap action      | Silver alloy     | 0,2 [1.8]                   |    | -                       | <b>GLAA01E7B</b>   | <b>GLAC01E7B</b> |  |
|   | 1NC/1NO             | Snap action      | Silver alloy     | 0,2 [1.8]                   |   | 1 LED (yellow)          | <b>GLFA01E7B</b>   | <b>GLFC01E7B</b> |  |
|   | 1NC/1NO             | Snap action      | Silver alloy     | 0,2 [1.8]                   |  | 2 LEDs (green & yellow) | <b>GLHA01E7B</b>   | -                |  |
|   | 1NC/1NO             | Snap action      | Gold-plated      | 0,2 [1.8]                   |  | -                       | -                  | <b>GLAC07E7B</b> |  |
|   | 1NC/1NO             | Slow action, BBM | Silver alloy     | 0,2 [1.8]                   |  | -                       | -                  | -                |  |
|   | 2NC/2NO             | Snap action      | Silver alloy     | 0,2 [1.8]                   |  | -                       | <b>GLAA20E7B</b>   | <b>GLAC20E7B</b> |  |
|   | 2NC/2NO             | Snap action      | Silver alloy     | 0,2 [1.8]                   |  | 1 LED (yellow)          | <b>GLFA24E7B</b>   | -                |  |
|  | 1NC/1NO             | Snap action      | Silver alloy     | 0,2 [1.8]                   |  | -                       | <b>GLAA01E7D</b>   | -                |  |

\* Note: When conduit style G1/2 (PF1/2) is required, change the 4th digit in the catalog listing to the letter D. For example, GLAA01A1A would change to GLAD01A1A for G1/2 conduit. When conduit style PG13,5 is required, change the 4th digit in the catalog listing to the letter B. For example, GLAA01A1A would change to GLAB01A1A for PG13,5 conduit.

# MICRO SWITCH Global Limit Switches, GLA Series

Table 6. MICRO SWITCH GLA Series Wobble Order Guide, continued

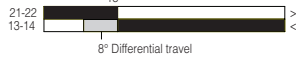
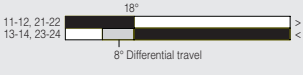
|   |                     |              |                  |                             |  |                        |                    | Catalog Listing* |  |
|---|---------------------|--------------|------------------|-----------------------------|--|------------------------|--------------------|------------------|--|
| Head Type   | Contact Arrangement | Contact Type | Contact Material | Operating Force max. N [lb] | Bar Chart (degrees)<br>■ contact closed<br>□ contact open                            | With LED Pilot Light/s | 0.5-14 NPT Conduit | 20 mm Conduit    |  |
|    | 1NC/1NO             | Snap action  | Silver alloy     | 0,1 [0.9]                   |    | -                      | <b>GLAA01K8A</b>   | -                |  |
|   | 1NC/1NO             | Snap action  | Silver alloy     | 0,1 [0.9]                   |    | -                      | <b>GLAA01K8B</b>   | -                |  |
|   | 2NC/2NO             | Snap action  | Silver alloy     | 0,1 [0.9]                   |  | -                      | <b>GLAA20K8B</b>   | <b>GLAC20K8B</b> |  |
|  | 1NC/1NO             | Snap action  | Silver alloy     | 0,1 [0.9]                   |  | -                      | <b>GLAA01K8C</b>   | -                |  |
|   | 2NC/2NO             | Snap action  | Silver alloy     | 0,1 [0.9]                   |  | -                      | <b>GLAA20K8C</b>   | -                |  |

\* Note: When conduit style G1/2 (PF1/2) is required, change the 4th digit in the catalog listing to the letter D. For example, GLAA01A1A would change to GLAD01A1A for G1/2 conduit. When conduit style PG13,5 is required, change the 4th digit in the catalog listing to the letter B. For example, GLAA01A1A would change to GLAB01A1A for PG13,5 conduit.

# MICRO SWITCH Global Limit Switches, GLA Series

Table 7. MICRO SWITCH GLA Series Top Roller Lever Order Guide

|   |                     |                  |                  |                             |  |                        | Catalog Listing*   |                |  |
|---|---------------------|------------------|------------------|-----------------------------|--|------------------------|--------------------|----------------|--|
| Head Type   | Contact Arrangement | Contact Type     | Contact Material | Operating Force max. N [lb] | Bar Chart (millimeters)<br>■ contact closed<br>□ contact open                      | With LED Pilot Light/s | 0.5-14 NPT Conduit | 20 mm Conduit  |  |
| <br>Top roller lever | 1NC/1NO             | Snap action      | Silver alloy     | 9,5 [2.1]                   |  | —                      | <b>GLAA01D</b>     | <b>GLAC01D</b> |  |
|   | 1NC/1NO             | Snap action      | Silver alloy     | 9,5 [2.1]                   |  | 1 LED (yellow)         | <b>GLFA01D</b>     | —              |  |
|   | 1NC/1NO             | Slow action, MBB | Silver alloy     | 9,5 [2.1]                   |  | —                      | <b>GLAA04D</b>     | —              |  |
|   | 2NC/2NO             | Snap action      | Silver alloy     | 9,5 [2.1]                   |  | —                      | <b>GLAA20D</b>     | <b>GLAC20D</b> |  |
|   | 2NC/2NO             | Snap action      | Gold-plated      | 9,5 [2.1]                   |  | —                      | <b>GLAA22D</b>     | <b>GLAC22D</b> |  |

\* Note: When conduit style G1/2 (PF1/2) is required, change the 4th digit in the catalog listing to the letter D. For example, GLAA01A1A would change to GLAD01A1A for G1/2 conduit. When conduit style PG13,5 is required, change the 4th digit in the catalog listing to the letter B. For example, GLAA01A1A would change to GLAB01A1A for PG13,5 conduit.

\*\* Positive opening occurs.

# MICRO SWITCH Global Limit Switches, GLA Series

Table 8. MICRO SWITCH GLB Series Side Rotary Order Guide (Plug-in Body)

|  |   |              |                  |                                   |  |  | Catalog Listing*   |               |           |
|--|---|--------------|------------------|-----------------------------------|--|--|--------------------|---------------|-----------|
| Head Type  | Contact Arrangement                         | Contact Type | Contact Material | Operating Torque max. Nm [in.-lb] | Bar Chart (degrees)<br>■ contact closed<br>□ contact open                            | With LED Pilot Light/s   | 0.5-14 NPT Conduit | 20 mm Conduit |           |
|  | Side rotary, no lever                       | 1NC/1NO      | Snap action      | Silver alloy                      | 0,33 [2.9]   |    | -                  | GLBA02A       | GLBC02A   |
|  | Side rotary, fixed lever, nylon roller      | 1NC/1NO      | Snap action      | Silver alloy                      | 0,33 [2.9]   |    | -                  | GLBA02A1A     | -         |
|  | Side rotary, fixed lever, steel roller      | 1NC/1NO      | Snap action      | Silver alloy                      | 0,33 [2.9]   |    | -                  | GLBA02A1B     | GLBC02A1B |
|  |   | 1NC/1NO      | Snap action      | Silver alloy                      | 0,33 [2.9]   |    | 1 LED (yellow)     | GLGA12A1B     | GLGC12A1B |
|  | Side rotary, adjustable lever, nylon roller | 1NC/1NO      | Snap action      | Silver alloy                      | 0,33 [2.9]   |  | -                  | GLBA02A2A     | GLBC02A2A |
|  | Side rotary, adjustable lever, steel roller | 1NC/1NO      | Snap action      | Silver alloy                      | 0,33 [2.9]   |  | -                  | GLBA02A2B     | GLBC02A2B |
|  |   | 1NC/1NO      | Snap action      | Silver alloy                      | 0,33 [2.9]   |  | 1 LED (yellow)     | GLGA12A2B     | -         |
|  | Side rotary, adjustable aluminum rod        | 1NC/1NO      | Snap action      | Silver alloy                      | 0,33 [2.9]   |  | -                  | GLBA02A4J     | GLBC02A4J |
| 1NC/1NO  |   | Snap action  | Silver alloy     | 0,33 [2.9]                        |  | 1 LED (yellow)   | GLGA12A4J          | -             |           |

\* Note: When conduit style G1/2 (PF1/2) is required, change the 4th digit in the catalog listing to the letter D. For example, GLA01A1A would change to GLAD01A1A for G1/2 conduit. When conduit style PG13,5 is required, change the 4th digit in the catalog listing to the letter B. For example, GLA01A1A would change to GLAB01A1A for PG13,5 conduit.

\*\* Positive opening occurs.

# MICRO SWITCH Global Limit Switches, GLA Series

Table 9. MICRO SWITCH GLB Series Top Plunger Order Guide (Plug-in Body)

|   |                     |              |             |                             |   |  | Catalog Listing*   |               |         |
|---|---------------------|--------------|-------------|-----------------------------|---|--|--------------------|---------------|---------|
| Head Type   | Contact Arrangement | Contact Type | Contact Mtl | Operating Force max. N [lb] | Bar Chart (millimeters)<br>■ contact closed<br>□ contact open | With LED Pilot Light/s   | 0.5-14 NPT Conduit | 20 mm Conduit |         |
|  | Top pin plunger     | 1NC/1NO      | Snap action | Silver alloy                | 16 [3.6]  |  | -                  | GLBA02B       | GLBC02B |
|   |                     | 1NC/1NO      | Snap action | Silver alloy                | 16 [3.6]  |  | 1 LED (yellow)     | GLGA12B       | GLGC12B |
|   | Top roller plunger  | 1NC/1NO      | Snap action | Silver alloy                | 16 [3.6]  |  | -                  | GLBA02C       | GLBC02C |
|   |                     | 1NC/1NO      | Snap action | Silver alloy                | 16 [3.6]  |  | 1 LED (yellow)     | GLGA12C       | -       |

Table 10. MICRO SWITCH GLB Series Top Roller Lever Order Guide (Plug-in Body)

|   |                     |              |             |                             |   |  | Catalog Listing*   |               |         |
|---|---------------------|--------------|-------------|-----------------------------|---|--|--------------------|---------------|---------|
| Head Type   | Contact Arrangement | Contact Type | Contact Mtl | Operating Force max. N [lb] | Bar Chart (millimeters)<br>■ contact closed<br>□ contact open | With LED Pilot Light   | 0.5-14 NPT Conduit | 20 mm Conduit |         |
|  | Top roller lever    | 1NC/1NO      | Snap action | Silver alloy                | 9.5 [2.1]   |  | -                  | GLBA02D       | GLBC02D |
|   |                     | 1NC/1NO      | Snap action | Silver alloy                | 9.5 [2.1]   |  | 1 LED (yellow)     | GLGA12D       | -       |

\* Note: When conduit style G1/2 (PF1/2) is required, change the 4th digit in the catalog listing to the letter D. For example, GLAA01A1A would change to GLAD01A1A for G1/2 conduit. When conduit style PG13,5 is required, change the 4th digit in the catalog listing to the letter B. For example, GLAA01A1A would change to GLAB01A1A for PG13,5 conduit.

\*\* Positive opening occurs.

# MICRO SWITCH Global Limit Switches, GLA Series

Table 11. MICRO SWITCH GLB Series Wobble Order Guide (Plug-in Body)

|   |                                  |              |              |                             |   |   | Catalog Listing*   |               |           |
|---|----------------------------------|--------------|--------------|-----------------------------|---|---|--------------------|---------------|-----------|
| Head Type   | Contact Arrangement              | Contact Type | Contact Mtl  | Operating Force max. N [lb] | Bar Chart (degrees)<br>■ contact closed<br>□ contact open                           | With LED Pilot Light/s  | 0.5-14 NPT Conduit | 20 mm Conduit |           |
|  | Wobble stick, 150 mm plastic rod | 1NC/1NO      | Snap action  | Silver alloy                | 0,1 [0.9]   |  | -                  | GLBA02E7A     | -         |
|   | Wobble stick, 141 mm coil spring | 1NC/1NO      | Snap action  | Silver alloy                | 0,1 [0.9]   |  | -                  | GLBA02E7B     | GLBC02E7B |
|   | Wobble stick, 141 mm coil spring | 1NC/1NO      | Snap action  | Silver alloy                | 0,1 [0.9]   |  | 1 LED (yellow)     | GLGA12E7B     | -         |
|   | Cat Whisker, 190 mm sst wire     | 1NC/1NO      | Snap action  | Silver alloy                | 0,1 [0.9]   |  | -                  | GLBA02K8B     | -         |
| Cat whisker, 141 mm sst coil spring   | 1NC/1NO                          | Snap action  | Silver alloy | 0,1 [0.9]                   |  | -   | GLBA02K8C          | -             |           |

\* Note: When conduit style G1/2 (PF1/2) is required, change the 4th digit in the catalog listing to the letter D. For example, GLA**A**01A1A would change to GLA**D**01A1A for G1/2 conduit. When conduit style PG13,5 is required, change the 4th digit in the catalog listing to the letter B. For example, GLA**A**01A1A would change to GLA-**B**01A1A for PG13,5 conduit.



# MICRO SWITCH Global Limit Switches, GLA Series

## Product Dimensions: GLA Series

Figure 2. Fixed Lever, Side Rotary Switch - Non-plug-in Body Style, GLZ51 Style Lever, and GLA Body



Figure 3. Fixed Lever, Side Rotary Switch - Plug-in Body Style, GLZ51 Style Lever, and GLB Body



# MICRO SWITCH Global Limit Switches, GLA Series

Figure 4. Adjustable Lever Dimensions, GLZ52



| LEVER  | ROLLER<br>MATL | X DIM        | Y DIM          | Z DIM          |
|--------|----------------|--------------|----------------|----------------|
| GLZ52A | NYLON          | 19,1<br>.75  | 65,9<br>2.59   | 6,4<br>.25     |
| GLZ52B | STEEL          | 19,1<br>.75  | 65,9<br>2.59   | 6,4<br>.25     |
| GLZ52D | NYLON          | 38,1<br>1.5  | 65,9<br>2.59   | 6,4<br>.25     |
| GLZ52E | NYLON          | 19,1<br>.75  | 79,37<br>3.125 | 33,07<br>1.300 |
| GLZ52W | RUBBER         | 40,0<br>1.6  | 71,5<br>2.81   | 12,7<br>.5     |
| GLZ52Y | RUBBER         | 50,0<br>1.97 | 68,8<br>2.71   | 10,0<br>.39    |

Figure 5. Aluminum Rod Lever Dimensions, GLZ54



# MICRO SWITCH Global Limit Switches, GLA Series

**Figure 6. Pin Plunger Dimensions**



**Top Pin Plunger**

Refer to Figure 2 or 3 for other dimensions

**Figure 7. Roller Plunger Dimensions**

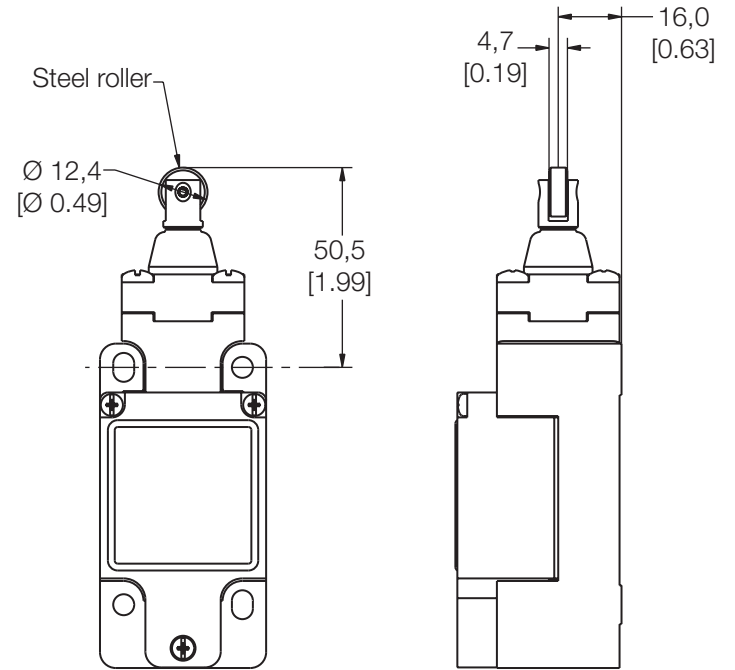

**Top Roller Plunger**

Refer to Figure 2 or 3 for other dimensions

**Figure 8. Roller Lever Dimensions**



**Top Roller Lever**

Refer to Figure 2 or 3 for other dimensions

# MICRO SWITCH Global Limit Switches, GLA Series

## Head Code: E • WOBBLE AND CAT WHISKER ACTUATOR DIMENSIONS

Figure 9. Coil Actuator

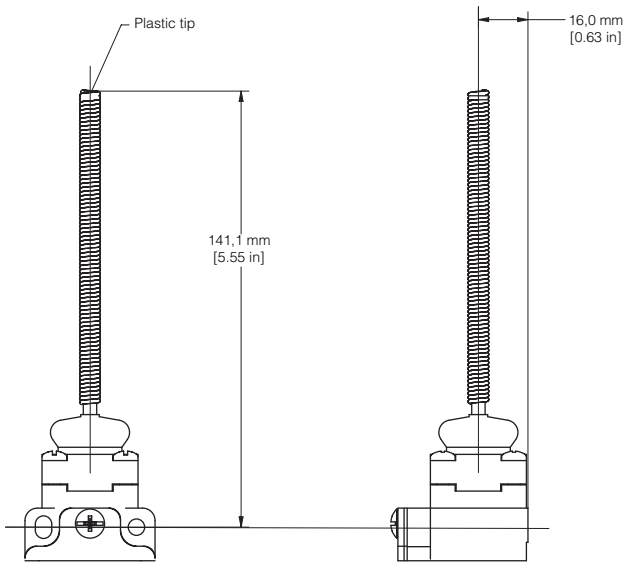

Refer to Figure 2 or 3 for other dimensions

Figure 10. Plastic Rod and Flexible Cable

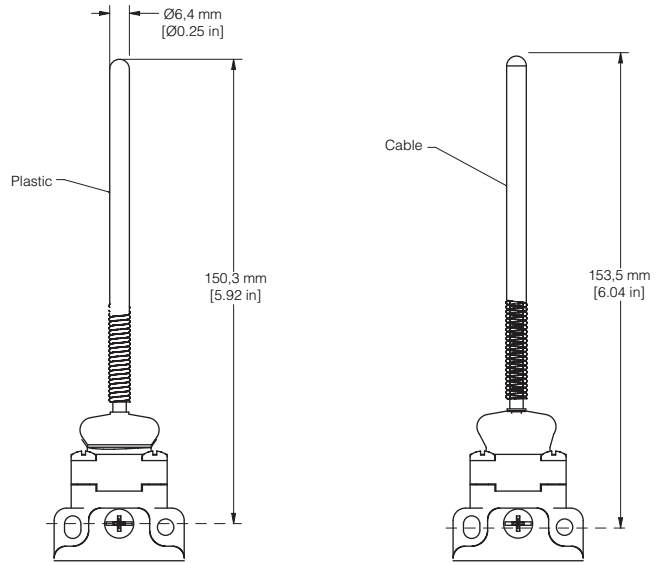

Refer to Figure 2 or 3 for other dimensions

Figure 11. Cat Whisker Wobbles

**5.5 inches (stainless steel)**

**6.5 inches (stainless steel)**

**7.5 inches (stainless steel)**

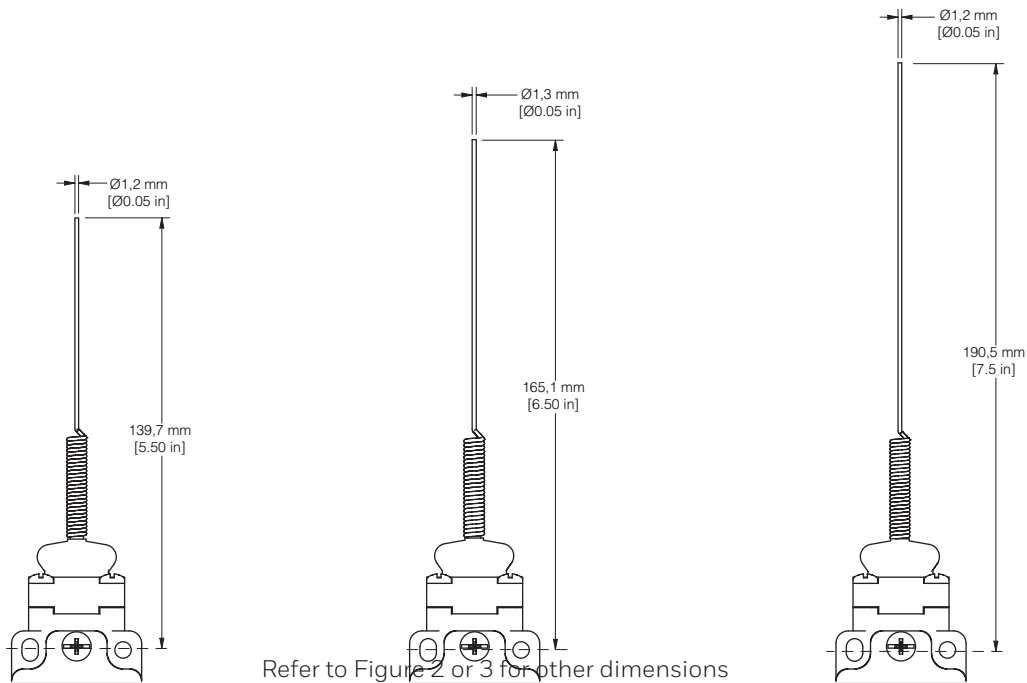

Refer to Figure 2 or 3 for other dimensions

# MICRO SWITCH Global Limit Switches, GLA Series

## APPLICATION INFORMATION

### Side Rotary Assemblies

The side rotary assemblies incorporate a feature for adjusting the free position of the side rotary lever. The EN 50041 body style allows infinite adjustment and reclamp. See the following diagrams for details of the mechanism in each case.

Figure 12. Standard EN 50041 Body Style

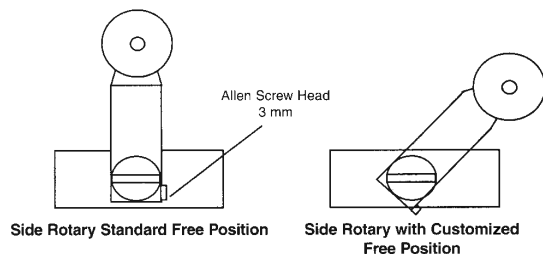

There are two lever mounting options:

1. By fully seating the lever in one of the four 90° detent positions on the shaft hub which provides positive lever retention.
2. By mounting the lever on the serrated portion of the shaft (which enables the lever to be mounted in any position).

To change the rotary lever's free position:

1. Use a 3 mm hex Allen wrench to loosen the Allen screw, as shown in Figure 13, below.
2. Back off the lever 2 mm and move it to the desired free position.
3. Retighten the Allen screw.
4. Check to see if the free position is satisfactory for the application.
5. Repeat the adjustment procedure if necessary.

A teller tab located at the bottom of the lever (see diagram below) helps prevent lever slippage. It enables the installer to detect the correct tightening torque. When this tab cannot be moved, the Allen screw has been tightened properly.

Figure 13. Allen Screw and Teller Tab Location



### EN 50041 Side Rotary Actuator Direction Adjustment

As furnished, GLS rotary switches will operate when the lever is rotated from either the left or right. They can be field modified to operate in one direction only (Clockwise CW; Counter clockwise CCW) by following these steps:

1. Carefully remove the complete head assembly.
2. Turn the head assembly upside down as shown in Figure 14.
3. Pull the plunger mechanism out and rotate it through 90° increments until the alignment tab points to the desired function (CW, CCW, or CW and CCW).
4. Push plunger mechanism in.
5. Reassemble the head assembly and re-test the switch in its application.

Figure 14. Actuation Adjustment

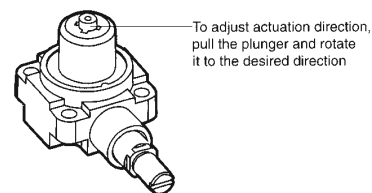

## REPLACEMENT INSTRUCTIONS

All levers for side rotary assemblies are available as replacement parts. All basics, except the plug-in, can be replaced. All EN 50041 heads can be replaced. The replacement procedures for these components are straightforward in nature.

### Side Rotary Levers

Remove the lever from the product being replaced. On EN 50041 product this is achieved by loosening the Allen screw holding the lever on the shaft. Replace the lever and tighten the Allen screw or combination screw. Re-test the switch in its application.

### Heads

All EN 50041 style switch heads can be removed and replaced.

1. Remove the head by unscrewing the four retaining screws on the head assembly.
2. Ensure replacement part is identical to one being removed.
3. Re-test the assembly and ensure correct operation.

### Basic Switches

#### Non-plug-in

Basic switches can be removed and replaced by following this procedure:

1. Remove the cover from the body.
2. Before disconnecting the switch wiring, carefully note the wiring arrangement for your application, particularly the safety ground connection.
3. Remove the basic switch retaining screw.
4. Remove the basic switch and install the replacement basic switch.
5. Use the retaining screw to install the new basic switch – ensure that it is correctly seated in the switch body.
6. Wire the switch terminals as before.
7. Before replacing the cover – ensure that the basic switch wires are not twisted or otherwise lifted from the basic switch (to prevent them from becoming trapped when the cover is replaced).
8. Test the switch in its application.

Figure 15. Retaining screw location

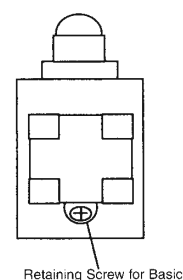

# MICRO SWITCH Global Limit Switches, GLA Series

## Basic Switches

Plug-in EN50041 body style

The switch enclosure portion of this two-piece body style plugs into a pre-wired terminal block mounted in the application. Replacement is accomplished by unplugging the old switch enclosure and plugging-in a new switch enclosure (basics are permanently staked in the switch enclosure).

## LED WIRING

The GLF, GLG, and GLH versions of GLS (EN 50041) come complete with LED indicators. These indicators can be wired in a variety of ways. Operation can indicate switch free or switch operated depending on the wiring arrangement employed. The table below indicates the body styles and indicators offered.

**Table 12. LED Series**

| Body | Function      | Specification                             |
|------|---------------|---|
| GLF  | 1 LED         | 12 → 250 Vac and dc less than 1.5 mA draw |
| GLG  | 1 LED plug-in | 12 → 250 Vac and dc less than 1.5 mA draw |
| GLH  | 2 LED         | 18 → 30 Vdc 7 mA typ. current draw        |

The following wiring diagrams show possible configurations that can be used for the LEDs. Combinations of these arrangements can be used where the dual LED versions of GLS are employed.

**Figure 16. Wiring Diagram 1**



In Figure 16, Wiring Diagram 1, the basic switch contact is open. The current for the LED can flow through the LED (via the load) and the LED illuminates.

**Figure 17. Wiring Diagram 2**



In Figure 17, Wiring Diagram 2, the basic switch contact is closed. The current for the LED cannot flow through the LED and the LED will not illuminate.

**Figure 18. Wiring Diagram 3**



In Figure 18, Wiring Diagram 3, regardless of the position of the basic switch, the current for the LED can flow through the LED and the LED will illuminate indicating power available.

**Figure 19. Wiring Diagram 4**









In Figure 19, Wiring Diagram 4, when the load is energized the LED will illuminate. The above examples suggest options with these versions of GLS. The LED pilot lights should be treated as "for indication only" devices.

**Note:**

While every effort is made to ensure that the above guidelines are accurate, no responsibility can be accepted for failure to apply good engineering practice to machinery design and use of Honeywell products. Never apply any of the procedures outlined above on live circuits. Ensure that testing of changes is carried out with no risk of injury during tests. These guidelines are produced to help our customers make the right choices in applying our Limit Switches to general applications. Contact your local Honeywell representative if you have any difficulties.

## MICRO SWITCH Global Limit Switches, GLA Series

### REPLACEMENT PARTS - Levers

|   | Catalog Listing | Rod/Roller Material          | Rod/Roller Dia. mm [in] | Roller Width mm [in] |
|---|-----------------|------------------------------|-------------------------|----------------------|
| <b>Fixed length lever; 38,1 mm [1.5 in] radius</b>                                  |                 |                              |                         |                      |
|    | GLZ51A          | Nylon                        | 19,0 [0.75]             | 6,35 [0.25]          |
|   | GLZ51B          | Steel                        | 19,0 [0.75]             | 6,35 [0.25]          |
|   | GLZ51C          | Nylon                        | 25,4 [1.00]             | 12,7 [0.50]          |
|   | GLZ51E          | Bronze                       | 19,0 [0.75]             | 6,35 [0.25]          |
|   | GLZ51T          | SST                          | 19,0 [0.75]             | 9,5 [0.38]           |
|   | GLZ51Y          | Rubber                       | 50,0 [1.97]             | 10,0 [0.39]          |
| <b>Adjustable length lever; 38,1 to 89,0 mm [1.5 to 3.5 in] radius</b>              |                 |                              |                         |                      |
|    | GLZ52A          | Nylon                        | 19,0 [0.75]             | 6,35 [0.25]          |
|   | GLZ52B          | Steel                        | 19,0 [0.75]             | 6,35 [0.25]          |
|   | GLZ52D          | Nylon                        | 38,1 [1.50]             | 6,35 [0.25]          |
|   | GLZ52E          | Nylon                        | 19,0 [0.75]             | 33,1 [1.30]          |
|   | GLZ52W          | Rubber                       | 40,7 [1.60]             | 12,7 [0.50]          |
|   | GLZ52Y          | Rubber                       | 50,0 [1.97]             | 10,0 [0.39]          |
| <b>Fixed length yoke lever; 38,1 mm [1.5in] radius</b>                              |                 |                              |                         |                      |
|   | GLZ53           | No rollers                   | n/a                     | n/a                  |
|   | GLZ53A          | Nylon                        | 19,0 [0.75]             | 6,35 [0.25]          |
|   | GLZ53B          | Steel                        | 19,0 [0.75]             | 6,35 [0.25]          |
|   | GLZ53E          | Bronze                       | 19,0 [0.75]             | 6,35 [0.25]          |
| <b>Adjustable rod levers</b>  |                 |                              |                         |                      |
|  | GLZ54           | Hub only                     | n/a                     | n/a                  |
|   | GLZ54J          | Alum. rod 200 mm [7.9 in]    | 3,17 mm [0.125 in]      | n/a                  |
|   | GLZ54K          | Alum. rod 140 mm [5.51 in]   | 3,17 mm [0.125 in]      | n/a                  |
|   | GLZ54N          | SST rod 318 mm [12.5 in]     | 3,17 mm [0.125 in]      | n/a                  |
| <b>Fixed length offset lever; 38,1 mm [1.5 in] radius</b>                           |                 |                              |                         |                      |
|  | GLZ55A          | Nylon                        | 19,0 [0.75]             | 6,35 [0.25]          |
|   | GLZ55B          | Steel                        | 19,0 [0.75]             | 6,35 [0.25]          |
|   | GLZ55E          | Bronze                       | 19,0 [0.75]             | 6,35 [0.25]          |
| <b>Fixed length spring rod</b>  |                 |                              |                         |                      |
|  | GLZ68           | Delrin rod, 305 mm [12.0 in] | 6,35 [0.25]             | n/a                  |

### REPLACEMENT PARTS - Basic Switches

| Basic Switch Code  | GLA Body | GLF Body (1 LED) | GLH Body (2 LEDs) |
|--|----------|------------------|-------------------|
| <b>01;</b> 1NC/1NO, snap action  | GLZ301   | GLZ301           | GLZ301            |
| <b>03;</b> 1NC/1NO, slow action BBM                                      | GLZ303   | GLZ303           | GLZ303            |
| <b>04;</b> 1NC/1NO, slow action MBB                                      | GLZ304   | GLZ304           | GLZ304            |
| <b>06;</b> 2NC, Slow action  | GLZ306   | GLZ306           | GLZ306            |
| <b>07;</b> 1NC/1NO, snap action, gold contacts                           | GLZ307   | GLZ307           | GLZ307            |
| <b>20;</b> 2NC/2NO, snap action  | GLZ320   | -                | -                 |
| <b>21;</b> 2NC/2NO, snap action, sequence                                | GLZ321   | -                | -                 |
| <b>22;</b> 2NC/2NO, snap action, gold contacts                           | GLZ322   | -                | -                 |
| <b>24;</b> 2NC/2NO, snap action, use with LED body                       | -        | GLZ324           | GLZ324            |
| <b>26;</b> 2NC/2NO, snap action, center neutral                          | GLZ326   | -                | -                 |
| <b>32;</b> 2NC/2NO, snap action, gold-plated contacts, use with LED body | -        | GLZ332           | GLZ332            |
| <b>33;</b> 1NC/1NO, slow action BBM, gold-plated contacts                | GLZ333   | GLZ333           | GLZ333            |
| <b>34;</b> 1NC/1NO, slow action, MBB, gold plated contacts               | GLZ334   | GLZ334           | GLZ334            |
| <b>36;</b> 2NC, slow action, gold-plated contacts                        | GLZ336   | GLZ336           | GLZ336            |



## MICRO SWITCH Global Limit Switches, GLA Series

---

### REPLACEMENT PARTS - Heads

| Head type                                  | GLA      | GLB      | GLF      | GLG      | GLH      |
|--|----------|----------|----------|----------|----------|
| <b>A;</b> Side rotary, less lever          | GLZ1AA   | GLZ1AA   | GLZ1AA   | GLZ1AA   | GLZ1AA   |
| <b>B;</b> Top pin plunger                  | GLZ1AB   | GLZ1AB   | GLZ1AB   | GLZ1AB   | GLZ1AB   |
| <b>C;</b> Top roller plunger               | GLZ1AC   | GLZ1AC   | GLZ1AC   | GLZ1AC   | GLZ1AC   |
| <b>D;</b> Top roller lever                 | GLZ1AD   | GLZ1AD   | GLZ1AD   | GLZ1AD   | GLZ1AD   |
| <b>E7A;</b> Wobble plastic rod, 150 mm     | GLZ1AE7A | GLZ1AE7A | GLZ1AE7A | GLZ1AE7A | GLZ1AE7A |
| <b>E7B;</b> Wobble sst coil spring, 141 mm | GLZ1AE7B | GLZ1AE7B | GLZ1AE7B | GLZ1AE7B | GLZ1AE7B |
| <b>E7D;</b> Wobble sst wire, 165 mm        | GLZ1AE7D | GLZ1AE7D | GLZ1AE7D | GLZ1AE7D | GLZ1AE7D |
| <b>K8A;</b> Cat whisker, 140 mm sst wire   | GLZ1AK8A | GLZ1AK8A | GLZ1AK8A | GLZ1AK8A | GLZ1AK8A |
| <b>K8B;</b> Cat whisker, 190 mm sst wire   | GLZ1AK8B | GLZ1AK8B | GLZ1AK8B | GLZ1AK8B | GLZ1AK8B |
| <b>K8C;</b> Cat whisker, sst coil spring   | GLZ1AK8C | GLZ1AK8C | GLZ1AK8C | GLZ1AK8C | GLZ1AK8C |

## ADDITIONAL MATERIALS

The following associated literature is available at [sensing.honeywell.com](http://sensing.honeywell.com):

- Product range guide
- Product application-specific information
  - Sensors and switches in front loaders
  - Sensors and switches in mobile cranes
  - Sensors and switches in oil rig applications

### **WARNING** **PERSONAL INJURY**

DO NOT USE these products as safety or emergency stop devices or in any other application where failure of the product could result in personal injury.

**Failure to comply with these instructions could result in death or serious injury.**

### **WARNING** **MISUSE OF DOCUMENTATION**

- The information presented in this product sheet is for reference only. Do not use this document as a product installation guide.
- Complete installation, operation, and maintenance information is provided in the instructions supplied with each product.

**Failure to comply with these instructions could result in death or serious injury.**

### **For more information**

Honeywell Sensing and Internet of Things services its customers through a worldwide network of sales offices and distributors. For application assistance, current specifications, pricing or the nearest Authorized Distributor, visit [sensing.honeywell.com](http://sensing.honeywell.com) or call:

|              |                     |
|--------------|---------------------|
| Asia Pacific | +65 6355-2828       |
| Europe       | +44 (0) 1698 481481 |
| USA/Canada   | +1-800-537-6945     |

### **Honeywell Sensing and Internet of Things**

9680 Old Bailes Road  
Fort Mill, SC 29707  
[www.honeywell.com](http://www.honeywell.com)

### **Warranty/Remedy**

Honeywell warrants goods of its manufacture as being free of defective materials and faulty workmanship during the applicable warranty period. Honeywell's standard product warranty applies unless agreed to otherwise by Honeywell in writing; please refer to your order acknowledgment or consult your local sales office for specific warranty details. If warranted goods are returned to Honeywell during the period of coverage, Honeywell will repair or replace, at its option, without charge those items that Honeywell, in its sole discretion, finds defective. **The foregoing is buyer's sole remedy and is in lieu of all other warranties, expressed or implied, including those of merchantability and fitness for a particular purpose. In no event shall Honeywell be liable for consequential, special, or indirect damages.**

While Honeywell may provide application assistance personally, through our literature and the Honeywell web site, it is buyer's sole responsibility to determine the suitability of the product in the application.

Specifications may change without notice. The information we supply is believed to be accurate and reliable as of this writing. However, Honeywell assumes no responsibility for its use.