

Base strip - MDSTB 2,5/10-G1 - 1762774

Please be informed that the data shown in this PDF Document is generated from our Online Catalog. Please find the complete data in the user's documentation. Our General Terms of Use for Downloads are valid (<http://phoenixcontact.com/download>)

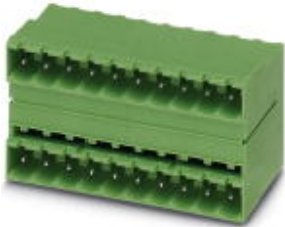

Header, Nominal current: 10 A, Rated voltage (III/2): 320 V, Number of positions: 10, Pitch: 5 mm, Color: green, Contact surface: Tin, Mounting: Wave soldering, In combination with MVSTB or FKCV plug components, both an MVSTBW (or FKCVW) and an MVSTBR plug (or FKCVR) must be used. Combination with TMSTBP plug components is not possible!

The figure shows a 10-pos. version with 20 contacts

Product Features

- MDSTBW 2,5/...-G with stand-off
- G1 types without offset levels, for flush installation on the front of devices
- Add-on ejectors for high-pos. connectors should be mounted to the left and right

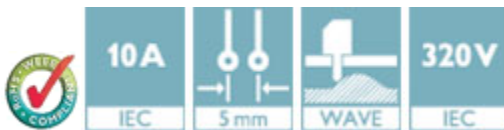

Key Commercial Data

Packing unit	1 pc
GTIN	 4 017918 031350
Weight per Piece (excluding packing)	18.08 g
Custom tariff number	85366990
Country of origin	Greece

Technical data

Dimensions

Length	22 mm
Pitch	5.00 mm
Dimension a	45 mm
Constructional height	29 mm
Length of the solder pin	3.5 mm
Pin dimensions	1 x 1 mm

Base strip - MDSTB 2,5/10-G1 - 1762774

Technical data

Dimensions

Hole diameter	1.4 mm
---------------	--------

General

Range of articles	MDSTB 2,5/...-G1
Insulating material group	I
Rated surge voltage (III/3)	4 kV
Rated surge voltage (III/2)	4 kV
Rated surge voltage (II/2)	4 kV
Rated voltage (III/3)	250 V
Rated voltage (III/2)	320 V
Rated voltage (II/2)	630 V
Connection in acc. with standard	EN-VDE
Nominal current I_N	10 A
Maximum load current	10 A
Insulating material	PA
Flammability rating according to UL 94	V0
Color	green
Number of positions	10

Standards and Regulations

Connection in acc. with standard	EN-VDE
	CSA
Flammability rating according to UL 94	V0

Classifications

eCl@ss

eCl@ss 4.0	272607xx
eCl@ss 4.1	27260701
eCl@ss 5.0	27260701
eCl@ss 5.1	27260701
eCl@ss 6.0	27260704
eCl@ss 7.0	27440402
eCl@ss 8.0	27440402
eCl@ss 9.0	27440402

ETIM

ETIM 3.0	EC001121
----------	----------

Base strip - MDSTB 2,5/10-G1 - 1762774

Classifications

ETIM

ETIM 4.0	EC002637
ETIM 5.0	EC002637

UNSPSC

UNSPSC 6.01	30211810
UNSPSC 7.0901	39121409
UNSPSC 11	39121409
UNSPSC 12.01	39121409
UNSPSC 13.2	39121409

Approvals

Approvals

Approvals

CSA / VDE Gutachten mit Fertigungsüberwachung / IEC60335 CB Scheme / EAC / cULus Recognized / EAC

Ex Approvals

Approvals submitted

Approval details

CSA 		
	B	D
Nominal current I _N	10 A	10 A
Nominal voltage U _N	300 V	300 V

VDE Gutachten mit Fertigungsüberwachung 	
Nominal current I _N	10 A
Nominal voltage U _N	250 V

Base strip - MDSTB 2,5/10-G1 - 1762774

Approvals

IECEE CB Scheme	
Nominal current I _N	10 A
Nominal voltage U _N	250 V

EAC

cULus Recognized		
	B	D
Nominal current I _N	15 A	10 A
Nominal voltage U _N	300 V	300 V

EAC

Accessories

Accessories

Coding element

Coding star - CR-MSTB - 1734401



Coding section, inserted into the recess in the header or the inverted plug, red insulating material

Filler plug

Accessories - MSTB-BL - 1755477



Keying cap, for forming sections, plugs onto header pin, green insulating material

Labeled terminal marker

Base strip - MDSTB 2,5/10-G1 - 1762774

Accessories

Marker card - SK 5/3,8:FORTL.ZAHLEN - 0804183



Marker card, Card, white, labeled, Horizontal: Consecutive numbers 1 - 10, 11 - 20, etc. up to 91 - (99)100, Mounting type: Adhesive, for terminal block width: 5 mm, Lettering field: 5 x 3.8 mm

Additional products

Printed-circuit board connector - TVFKC 1,5/10-ST - 1713910



Plug component, Nominal current: 10 A, Rated voltage (III/2): 320 V, Number of positions: 10, Pitch: 5 mm, Connection method: Push-in spring connection, Color: green, Contact surface: Tin

Printed-circuit board connector - TVFKCL 1,5/10-ST - 1716001

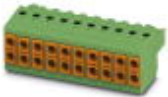

Plug component, Nominal current: 10 A, Rated voltage (III/2): 320 V, Number of positions: 10, Pitch: 5 mm, Connection method: Push-in spring connection, Color: green, Contact surface: Tin

Plug - QC 1,5/10-ST - 1718041



Plug component, Nominal current: 12 A, Rated voltage (III/2): 630 V, Number of positions: 10, Pitch: 5 mm, Connection method: Displacement connection, Color: green, Contact surface: Tin

Printed-circuit board connector - MSTB 2,5/10-ST - 1754601



Plug component, Nominal current: 12 A, Rated voltage (III/2): 320 V, Number of positions: 10, Pitch: 5 mm, Connection method: Screw connection with tension sleeve, Color: green, Contact surface: Tin

Base strip - MDSTB 2,5/10-G1 - 1762774

Accessories

Printed-circuit board connector - MSTB 2,5/10-STZ - 1759004



Plug component, Nominal current: 12 A, Rated voltage (III/2): 320 V, Number of positions: 10, Pitch: 5 mm, Connection method: Screw connection with tension sleeve, Color: green, Contact surface: Tin

Printed-circuit board connector - MSTBP 2,5/10-ST - 1765852



Plug component, Nominal current: 12 A, Rated voltage (III/2): 320 V, Number of positions: 10, Pitch: 5 mm, Connection method: Screw connection with tension sleeve, Color: green, Contact surface: Tin

Printed-circuit board connector - SMSTB 2,5/10-ST - 1768833



Plug component, Nominal current: 12 A, Rated voltage (III/2): 320 V, Number of positions: 10, Pitch: 5 mm, Connection method: Screw connection with tension sleeve, Color: green, Contact surface: Tin

Printed-circuit board connector - FRONT-MSTB 2,5/10-ST - 1779495



Plug component, Nominal current: 12 A, Rated voltage (III/2): 320 V, Number of positions: 10, Pitch: 5 mm, Connection method: Front screw connection, Color: green, Contact surface: Tin

Printed-circuit board connector - MVSTBR 2,5/10-ST - 1792090



Plug component, Nominal current: 12 A, Rated voltage (III/2): 320 V, Number of positions: 10, Pitch: 5 mm, Connection method: Screw connection with tension sleeve, Color: green, Contact surface: Tin

Base strip - MDSTB 2,5/10-G1 - 1762774

Accessories

Printed-circuit board connector - MVSTBW 2,5/10-ST - 1792605



Plug component, Nominal current: 12 A, Rated voltage (III/2): 320 V, Number of positions: 10, Pitch: 5 mm, Connection method: Screw connection with tension sleeve, Color: green, Contact surface: Tin

Printed-circuit board connector - FKCVR 2,5/10-ST - 1909799



Plug component, Nominal current: 12 A, Rated voltage (III/2): 320 V, Number of positions: 10, Pitch: 5 mm, Connection method: Push-in spring connection, Color: green, Contact surface: Tin

Printed-circuit board connector - FKCVW 2,5/10-ST - 1910115



Plug component, Nominal current: 12 A, Rated voltage (III/2): 320 V, Number of positions: 10, Pitch: 5 mm, Connection method: Push-in spring connection, Color: green, Contact surface: Tin

Printed-circuit board connector - FKC 2,5/10-ST - 1910432



Plug component, Nominal current: 12 A, Rated voltage (III/2): 320 V, Number of positions: 10, Pitch: 5 mm, Connection method: Push-in spring connection, Color: green, Contact surface: Tin

Printed-circuit board connector - FKCS 2,5/10-ST - 1974818



Plug component, Nominal current: 12 A, Rated voltage (III/2): 320 V, Number of positions: 10, Pitch: 5 mm, Connection method: Push-in spring connection, Color: green, Contact surface: Tin

Drawings

Base strip - MDSTB 2,5/10-G1 - 1762774

Dimensional drawing

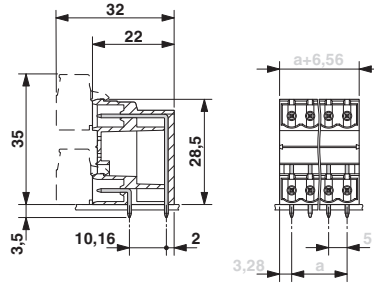

Drilling diagram

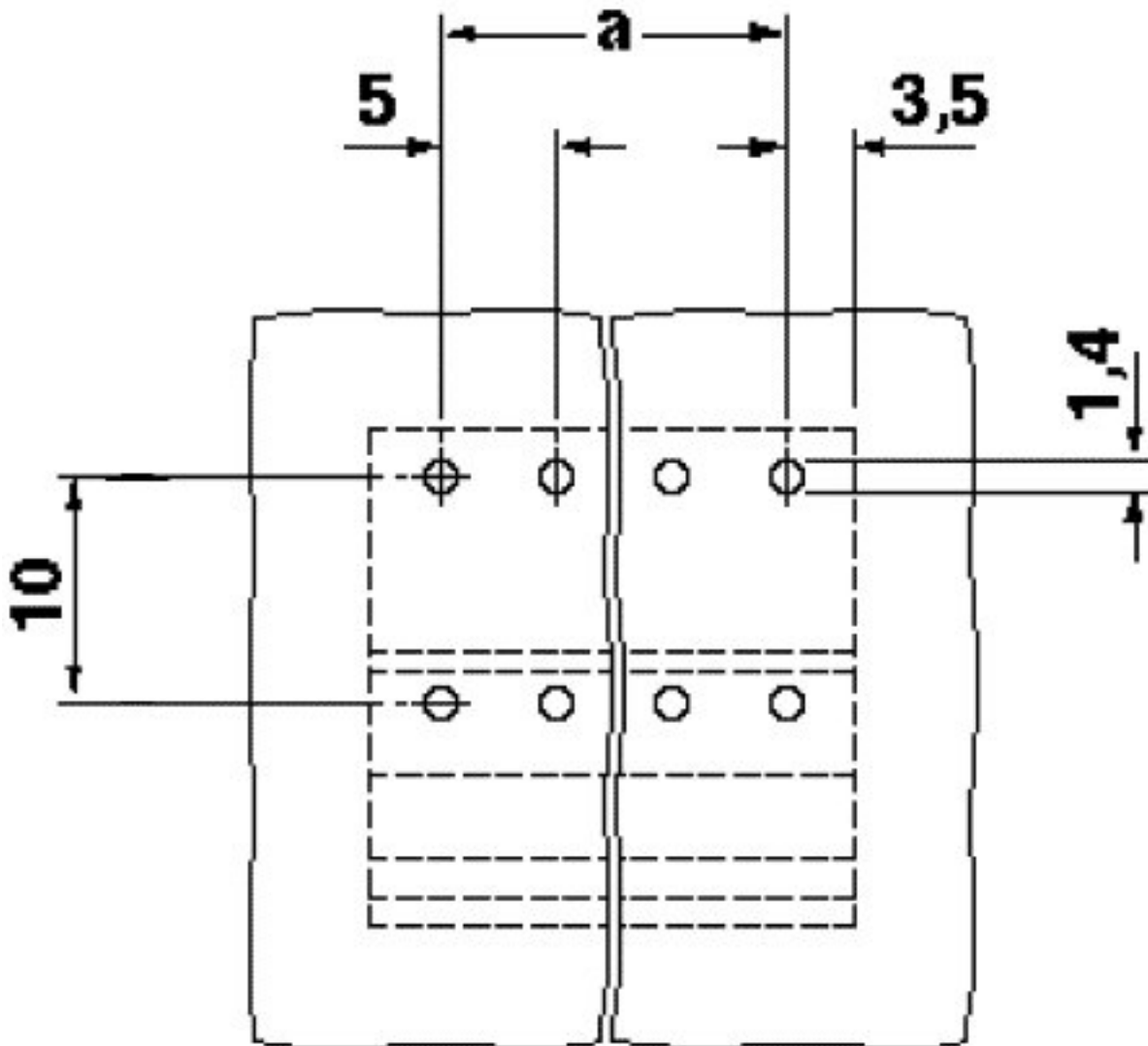

Mouser Electronics

Authorized Distributor

Click to View Pricing, Inventory, Delivery & Lifecycle Information:

[Phoenix Contact:](#)

[1762774](#)