

THIS DRAWING IS UNPUBLISHED. RELEASED FOR PUBLICATION 20
 © COPYRIGHT 20 BY - ALL RIGHTS RESERVED.

REVISIONS					
P	LTR	DESCRIPTION	DATE	DWN	APVD
C6		REVISED PER ECO-12-007711	26APR2012	KH	MS

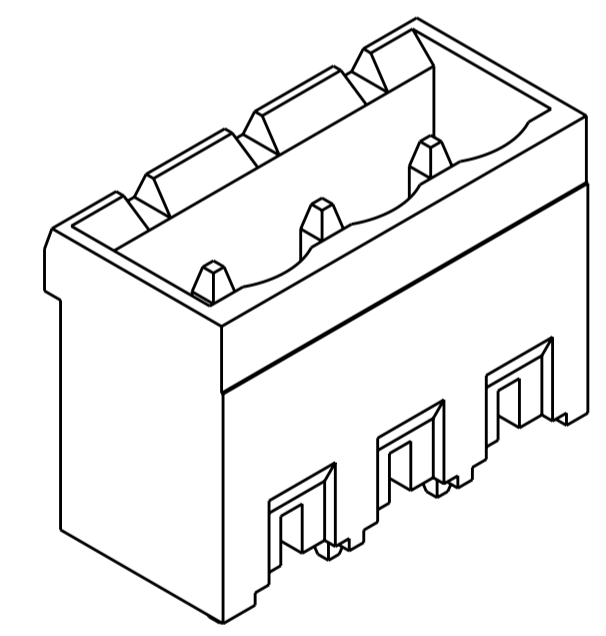

796636-3 AS SHOWN

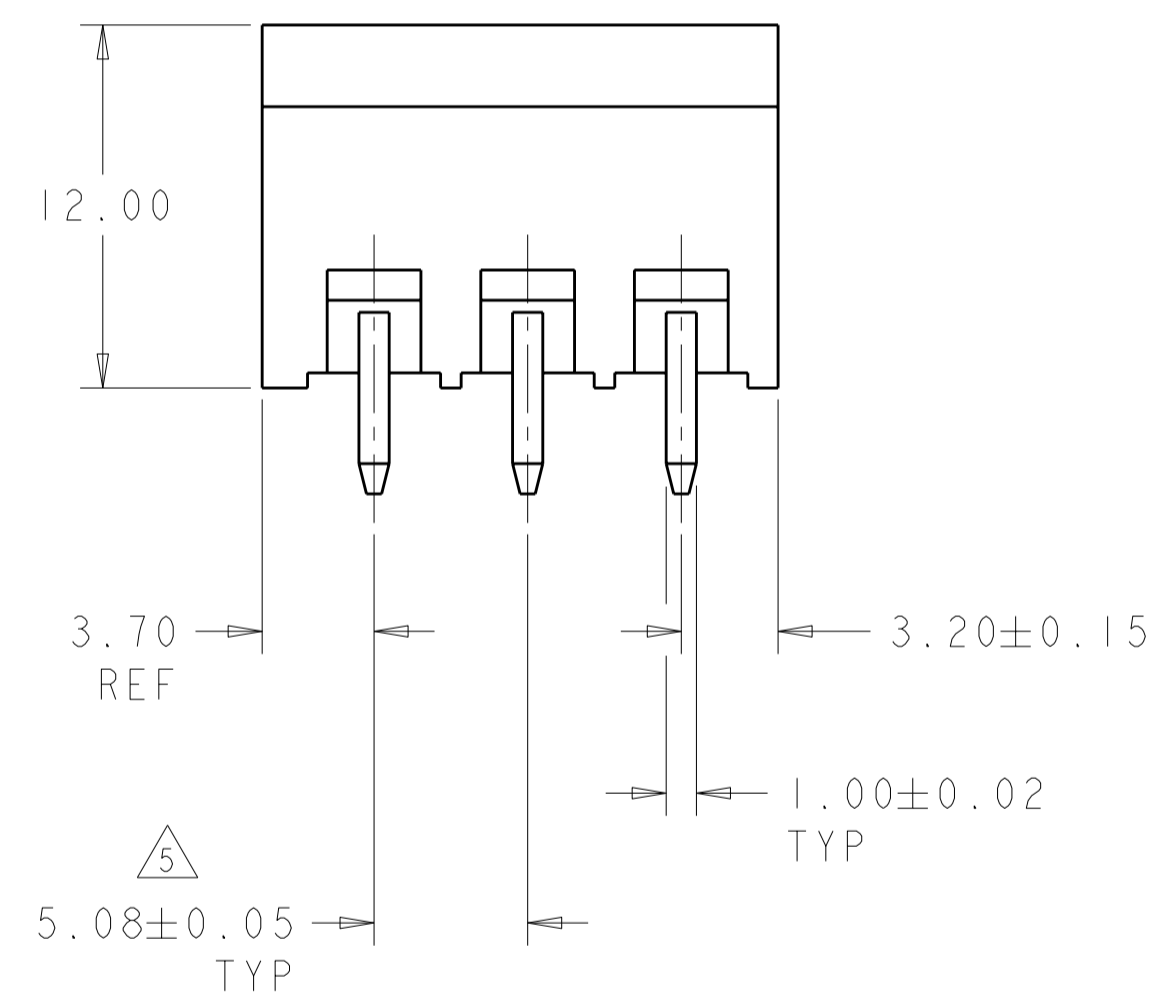
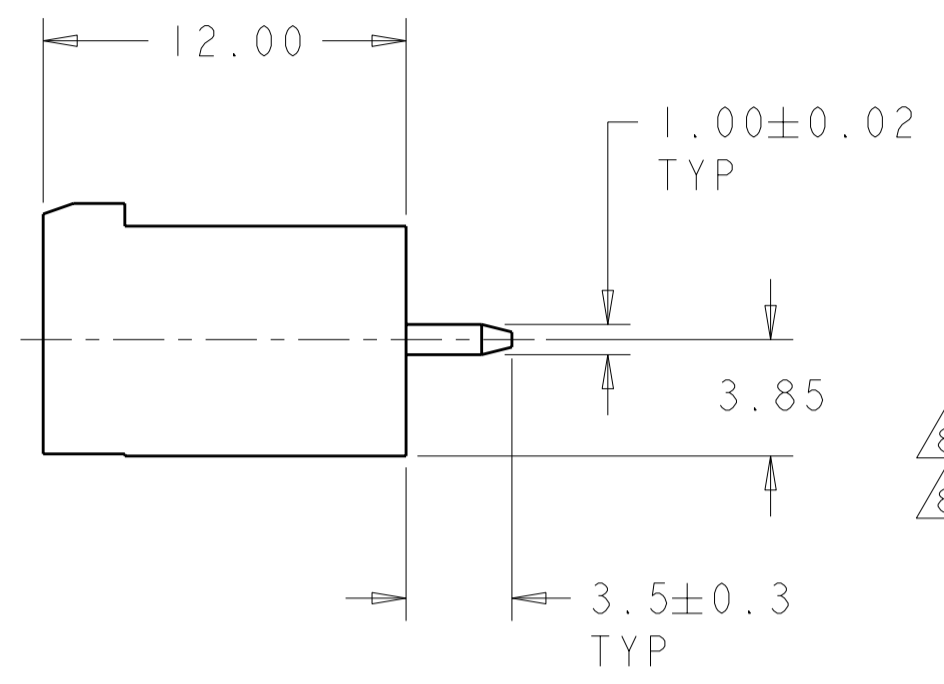
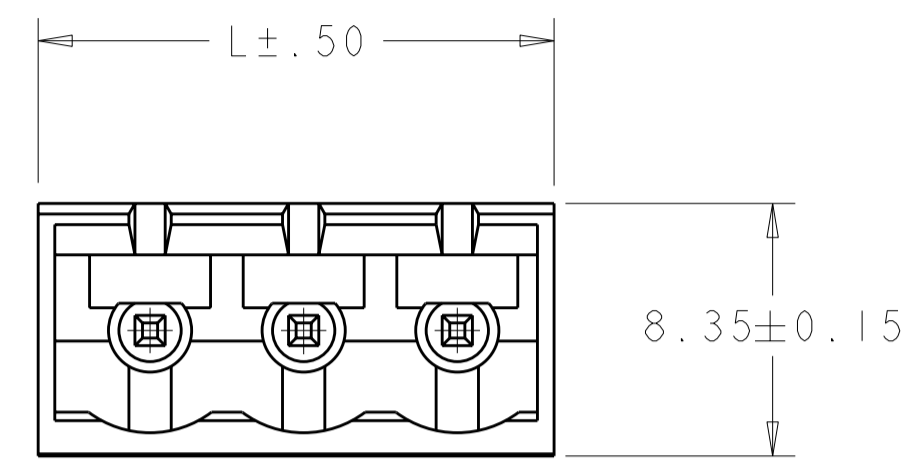
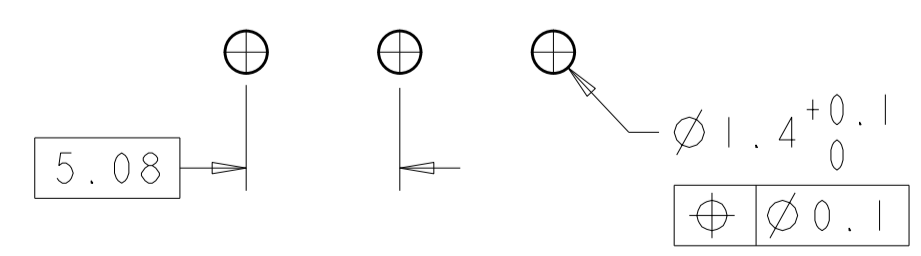

RECOMMENDED PC BOARD LAYOUT

8	TIN	-	DETAIL N	108.50	21	2-796636-9
8	TIN	-	DETAIL M	78.02	15	2-796636-8
	.762µm GOLD	-	-	42.46	8	2-796636-7
	TIN	6	DETAIL L	22.14	4	2-796636-6
	TIN	-	-	128.82	25	2-796636-5
	TIN	-	-	123.74	24	2-796636-4
	TIN	-	-	118.66	23	2-796636-3
	TIN	-	-	113.58	22	2-796636-2
	TIN	-	-	108.50	21	2-796636-1
	TIN	-	-	103.42	20	2-796636-0
	TIN	-	-	98.34	19	1-796636-9
	TIN	-	-	93.26	18	1-796636-8
	TIN	-	-	88.18	17	1-796636-7
	TIN	-	-	83.10	16	1-796636-6
	TIN	-	-	78.02	15	1-796636-5
	TIN	-	-	72.94	14	1-796636-4
	TIN	-	-	67.86	13	1-796636-3
	TIN	-	-	62.78	12	1-796636-2
	TIN	-	-	57.70	11	1-796636-1
	TIN	-	-	52.62	10	1-796636-0
	TIN	-	-	47.54	9	796636-9
	TIN	-	-	42.46	8	796636-8
	TIN	-	-	37.38	7	796636-7
	TIN	-	-	32.30	6	796636-6
	TIN	-	-	27.22	5	796636-5
	TIN	-	-	22.14	4	796636-4
	TIN	-	-	17.06	3	796636-3
	TIN	-	-	11.98	2	796636-2
CONTACT FINISH	MARKING	SPECIAL	DIM L	NO OF POSN	PART NUMBER	

THIS DRAWING IS A CONTROLLED DOCUMENT.

DWN: S. WELDON 19OCT2000
 CHK: D. BIEVENOUR 19OCT2000
 APVD: D. BIEVENOUR 19OCT2000

STE TE Connectivity

NAME: TERMI-BLOK HEADER ASSEMBLY, 180 DEGREE, CLOSED ENDS, 5.08mm PITCH

SIZE: A2 CAGE CODE: 00779 DRAWING NO: 796636

MATERIAL: TOLERANCES UNLESS OTHERWISE SPECIFIED: 0 PLC ±0.3, 1 PLC ±0.3, 2 PLC ±0.25, 3 PLC ±, 4 PLC ±, ANGLES ±, FINISH

APPLIC. SPEC: - WEIGHT: -

CUSTOMER DRAWING SCALE: 4:1 SHEET 1 OF 2 REV C6

THIS DRAWING IS UNPUBLISHED. RELEASED FOR PUBLICATION 20
 © COPYRIGHT 20 BY - ALL RIGHTS RESERVED.

LOC	DIST	REVISIONS			
P	LTR	DESCRIPTION	DATE	DWN	APVD
FT	0	-	SEE SHEET 1	-	-

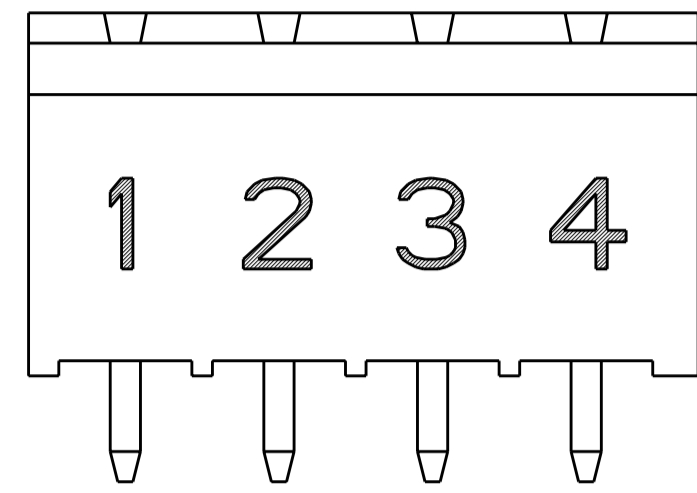

DETAIL L

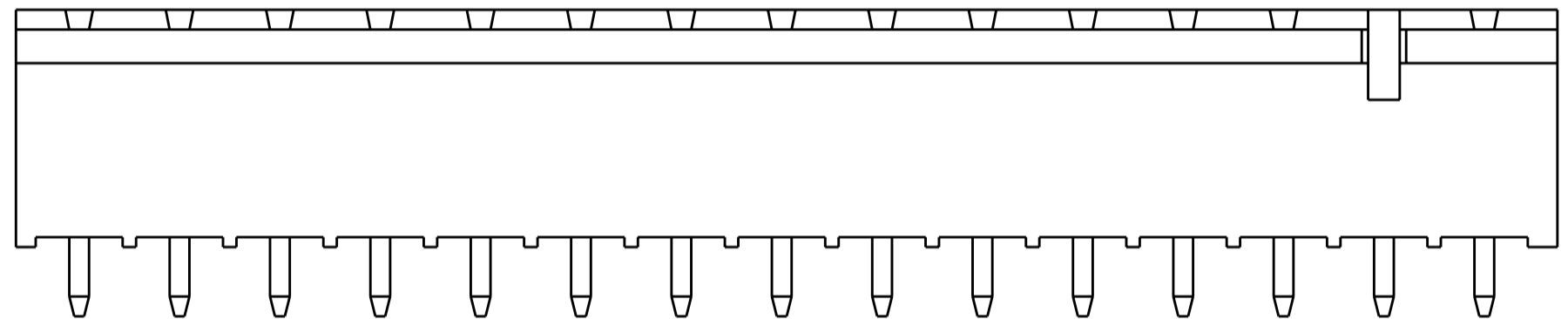

DETAIL M
2-796636-8

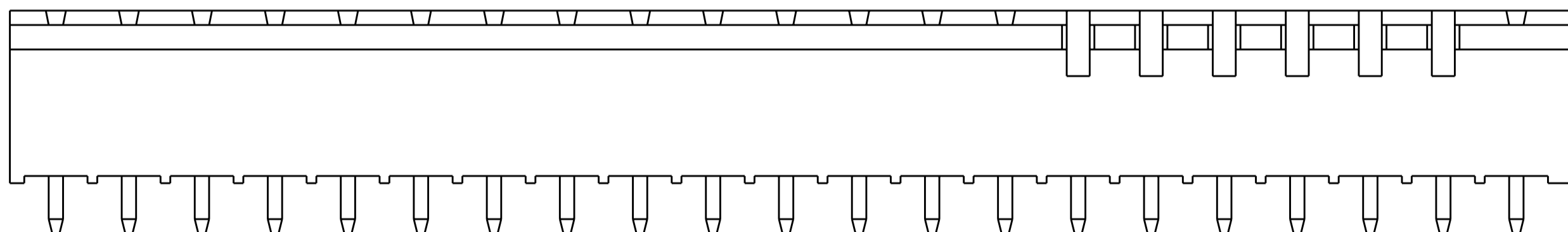

DETAIL N
2-796636-9

- 1. MATERIALS AND FINISH:
HOUSING: PA 6-6, UL 94-V0, COLOR: GREEN.
TERMINAL: COPPER ALLOY, TIN PLATED.
- 2. SUITABLE FOR 1,6-2, 4mm PC BOARD THICKNESS.
- 3. RECOGNIZED UNDER THE COMPONENT PROGRAM OF UNDERWRITERS LABORATORIES INC. FILE N° E60677.
- 4. IMQ CERTIFICATE WITH SURVEILLANCE IN CONFORMITY WITH IEC 998-1/998-2-1.}
- 5. NOT CUMULATIVE TOLERANCE
- 6. INK MARKED WHITE
NUMERICAL SEQUENCE: FROM LEFT TO RIGHT.
- 7. BUCHANAN LOGO TO APPEAR ON HOUSING, LOCATION OPTIONAL WHERE SPACE PERMITS.
- 8. KEYS TO BE GLUED IN PLACE AS SHOWN.

THIS DRAWING IS A CONTROLLED DOCUMENT.		DWN S. WELDON	19OCT2000	STE TE Connectivity													
DIMENSIONS: mm		CHK D. BIEVENOUR	19OCT2000														
TOLERANCES UNLESS OTHERWISE SPECIFIED:		APVD D. BIEVENOUR	19OCT2000														
<table border="0"> <tr><td>0 PLC</td><td>±</td></tr> <tr><td>1 PLC</td><td>±</td></tr> <tr><td>2 PLC</td><td>±</td></tr> <tr><td>3 PLC</td><td>±</td></tr> <tr><td>4 PLC</td><td>±</td></tr> <tr><td>ANGLES</td><td>±</td></tr> <tr><td>FINISH</td><td>±</td></tr> </table>		0 PLC	±		1 PLC	±	2 PLC	±	3 PLC	±	4 PLC	±	ANGLES	±	FINISH	±	PRODUCT SPEC
0 PLC	±																
1 PLC	±																
2 PLC	±																
3 PLC	±																
4 PLC	±																
ANGLES	±																
FINISH	±																
MATERIAL		APPLICATION SPEC	-	NAME TERMI-BLOK HEADER ASSEMBLY, 180 DEGREE, CLOSED ENDS, 5.08mm PITCH													
		WEIGHT	-	SIZE A200779													
		CUSTOMER DRAWING		CAGE CODE C-796636													
				DRAWING NO -													
				RESTRICTED TO -													
				SCALE 4:1 SHEET 2 OF 2 REV C6													

Mouser Electronics

Authorized Distributor

Click to View Pricing, Inventory, Delivery & Lifecycle Information:

[TE Connectivity:](#)

[796636-4](#)