



**SD-C Series 450W Discrete Bidirectional TVS Diode**  **AUTOMOTIVE GRADE**  **RoHS**  **GREEN**



**Pinout and Functional Block Diagram**

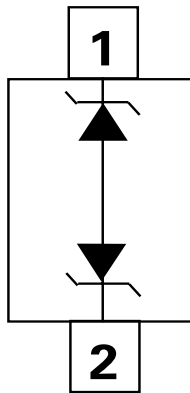

**Description**

The SD-C series can safely absorb repetitive ESD strikes at  $\pm 30\text{kV}$  (contact discharge, IEC 61000-4-2) without performance degradation and safely dissipate 30A (SD05C) of 8/20 $\mu\text{s}$  induced surge current (IEC 61000-4-5 2<sup>ND</sup> Edition) with very low clamping voltages.

**Features**

- ESD, IEC 61000-4-2,  $\pm 30\text{kV}$  contact,  $\pm 30\text{kV}$  air
- EFT, IEC 61000-4-4, 40A (5/50ns)
- Lightning, 30A (8/20 as defined in IEC 61000-4-5 2nd edition) SD05C
- Low clamping voltage
- Low leakage current
- Small SOD323 package fits 0805 footprints
- AEC-Q101 qualified
- RoHS Compliant and Lead Free
- Moisture Sensitivity Level (MSL-1)

**Applications**

- Switches / Buttons
- Test Equipment / Instrumentation
- Point-of-Sale Terminals
- Medical Equipment
- Notebooks / Desktops / Servers
- Computer Peripherals
- Automotive Electronics

**Additional Information**



**Datasheet**



**Resources**



**Samples**

Life Support Note:

**Not Intended for Use in Life Support or Life Saving Applications**

The products shown herein are not designed for use in life sustaining or life saving applications unless otherwise expressly indicated.

### Absolute Maximum Ratings

Symbol	Parameter	Value	Units
$P_{pk}$	Peak Pulse Power ( $t_p=8/20\mu s$ )	450	W
$T_{OP}$	Operating Temperature	-40 to 125	°C
$T_{STOR}$	Storage Temperature	-55 to 150	°C

Note:

CAUTION: Stresses above those listed in "Absolute Maximum Ratings" may cause permanent damage to the device. This is a stress only rating and operation of the component at these or any other conditions above those indicated in the operational sections of this specification is not implied.

### SD05C Electrical Characteristics ( $T_{OP}=25^\circ C$ )

Parameter	Symbol	Test Conditions	Min	Typ	Max	Units
Reverse Standoff Voltage	$V_{RWM}$	$I_R=1\mu A$	-	-	5.0	V
Breakdown Voltage	$V_R$	$I_R=1mA$	6.0	-	-	V
Reverse Leakage Current	$I_{LEAK}$	$V_R=5V$	-	-	1.0	$\mu A$
Clamp Voltage <sup>1</sup>	$V_C$	$I_{pp}=1A, t_p=8/20\mu s, Fwd$	-	-	10.0	V
		$I_{pp}=10A, t_p=8/20\mu s, Fwd$	-	-	14.5	V
Dynamic Resistance <sup>2</sup>	$R_{DYN}$	TLP, $t_p=100ns, I/O$ to Ground	-	0.31	-	$\Omega$
Peak Pulse Current	$I_{pp}$	$t_p=8/20\mu s$	-	-	30.0	A
ESD Withstand Voltage <sup>1</sup>	$V_{ESD}$	IEC 61000-4-2 (Contact Discharge)	$\pm 30$	-	-	kV
		IEC 61000-4-2 (Air Discharge)	$\pm 30$	-	-	kV
Diode Capacitance <sup>1</sup>	$C_{I/O-I/O}$	Reverse Bias=0V, f=1MHz	-	-	200	pF

### SD12C Electrical Characteristics ( $T_{OP}=25^\circ C$ )

Parameter	Symbol	Test Conditions	Min	Typ	Max	Units
Reverse Standoff Voltage	$V_{RWM}$	$I_R=1\mu A$	-	-	12.0	V
Breakdown Voltage	$V_R$	$I_R=1mA$	13.3	-	-	V
Reverse Leakage Current	$I_{LEAK}$	$V_R=12V$	-	-	1.0	$\mu A$
Clamp Voltage <sup>1</sup>	$V_C$	$I_{pp}=1A, t_p=8/20\mu s, Fwd$	-	-	18.5	V
		$I_{pp}=10A, t_p=8/20\mu s, Fwd$	-	-	23.0	V
Dynamic Resistance <sup>2</sup>	$R_{DYN}$	TLP, $t_p=100ns, I/O$ to Ground	-	0.41	-	$\Omega$
Peak Pulse Current	$I_{pp}$	$t_p=8/20\mu s$	-	-	17.0	A
ESD Withstand Voltage <sup>1</sup>	$V_{ESD}$	IEC 61000-4-2 (Contact Discharge)	$\pm 30$	-	-	kV
		IEC 61000-4-2 (Air Discharge)	$\pm 30$	-	-	kV
Diode Capacitance <sup>1</sup>	$C_{I/O-I/O}$	Reverse Bias=0V, f=1MHz	-	-	100	pF

**SD15C Electrical Characteristics (T<sub>OP</sub>=25°C)**

Parameter	Symbol	Test Conditions	Min	Typ	Max	Units
Reverse Standoff Voltage	V <sub>RWM</sub>	I <sub>R</sub> =1μA	-	-	15.0	V
Breakdown Voltage	V <sub>R</sub>	I <sub>R</sub> =1mA	16.7	-	-	V
Reverse Leakage Current	I <sub>LEAK</sub>	V <sub>R</sub> =15V	-	-	1.0	μA
Clamp Voltage <sup>1</sup>	V <sub>C</sub>	I <sub>PP</sub> =1A, t <sub>p</sub> =8/20μs, Fwd	-	-	24.0	V
		I <sub>PP</sub> =10A, t <sub>p</sub> =8/20μs, Fwd	-	-	31.0	V
Dynamic Resistance <sup>2</sup>	R <sub>DYN</sub>	TLP, tp=100ns, I/O to Ground	-	0.46	-	Ω
Peak Pulse Current	I <sub>PP</sub>	t <sub>p</sub> =8/20μs	-	-	12.0	A
ESD Withstand Voltage <sup>1</sup>	V <sub>ESD</sub>	IEC 61000-4-2 (Contact Discharge)	±30	-	-	kV
		IEC 61000-4-2 (Air Discharge)	±30	-	-	kV
Diode Capacitance <sup>1</sup>	C <sub>I/O-I/O</sub>	Reverse Bias=0V, f=1MHz	-	-	75	pF

**SD24C Electrical Characteristics (T<sub>OP</sub>=25°C)**

Parameter	Symbol	Test Conditions	Min	Typ	Max	Units
Reverse Standoff Voltage	V <sub>RWM</sub>	I <sub>R</sub> =1μA	-	-	24.0	V
Breakdown Voltage	V <sub>R</sub>	I <sub>R</sub> =1mA	26.7	-	-	V
Reverse Leakage Current	I <sub>LEAK</sub>	V <sub>R</sub> =24V	-	-	1.0	μA
Clamp Voltage <sup>1</sup>	V <sub>C</sub>	I <sub>PP</sub> =1A, t <sub>p</sub> =8/20μs, Fwd	-	-	34.0	V
		I <sub>PP</sub> =5A, t <sub>p</sub> =8/20μs, Fwd	-	-	42.0	V
Dynamic Resistance <sup>2</sup>	R <sub>DYN</sub>	TLP, tp=100ns, I/O to Ground	-	0.62	-	Ω
Peak Pulse Current	I <sub>PP</sub>	t <sub>p</sub> =8/20μs	-	-	7.0	A
ESD Withstand Voltage <sup>1</sup>	V <sub>ESD</sub>	IEC 61000-4-2 (Contact Discharge)	±30	-	-	kV
		IEC 61000-4-2 (Air Discharge)	±30	-	-	kV
Diode Capacitance <sup>1</sup>	C <sub>I/O-I/O</sub>	Reverse Bias=0V, f=1MHz	-	-	50	pF

**SD36C Electrical Characteristics (T<sub>OP</sub>=25°C)**

Parameter	Symbol	Test Conditions	Min	Typ	Max	Units
Reverse Standoff Voltage	V <sub>RWM</sub>	I <sub>R</sub> =1μA	-	-	36.0	V
Breakdown Voltage	V <sub>R</sub>	I <sub>R</sub> =1mA	40.0	-	-	V
Reverse Leakage Current	I <sub>LEAK</sub>	V <sub>R</sub> =36V	-	-	1.0	μA
Clamp Voltage <sup>1</sup>	V <sub>C</sub>	I <sub>PP</sub> =1A, t <sub>p</sub> =8/20μs, Fwd	-	-	50.0	V
		I <sub>PP</sub> =4A, t <sub>p</sub> =8/20μs, Fwd	-	-	60.0	V
Dynamic Resistance <sup>2</sup>	R <sub>DYN</sub>	TLP, tp=100ns, I/O to Ground	-	0.68	-	Ω
Peak Pulse Current	I <sub>PP</sub>	t <sub>p</sub> =8/20μs	-	-	5.0	A
ESD Withstand Voltage <sup>1</sup>	V <sub>ESD</sub>	IEC 61000-4-2 (Contact Discharge)	±30	-	-	kV
		IEC 61000-4-2 (Air Discharge)	±30	-	-	kV
Diode Capacitance <sup>1</sup>	C <sub>I/O-I/O</sub>	Reverse Bias=0V, f=1MHz	-	-	30	pF

Note:

- Parameter is guaranteed by design and/or component characterization.
- Transmission Line Pulse (TLP) with 100ns width and 200ps rise time.

**Capacitance vs. Bias**

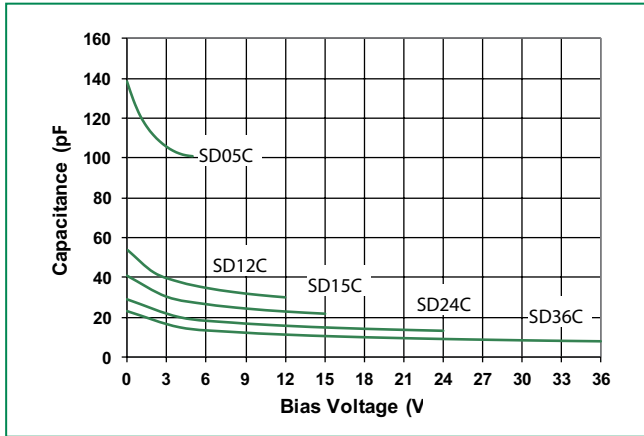

**Power Derating Curve**

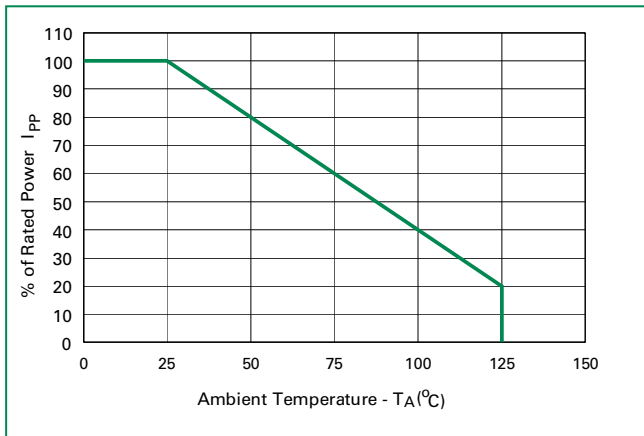

**8/20  $\mu$ s Pulse Waveform**

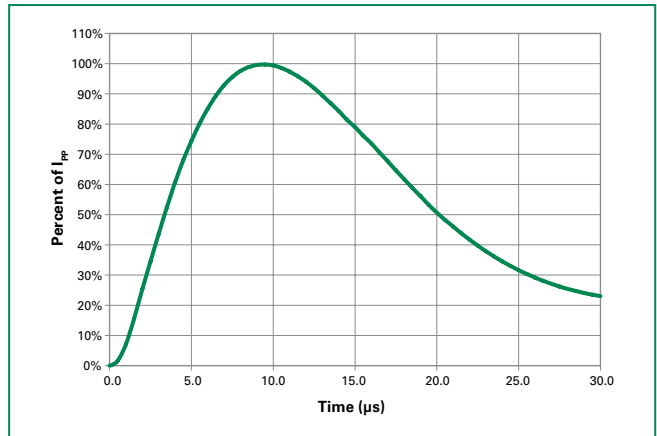

**SD05C Transmission Line Pulsing (TLP) Plot**

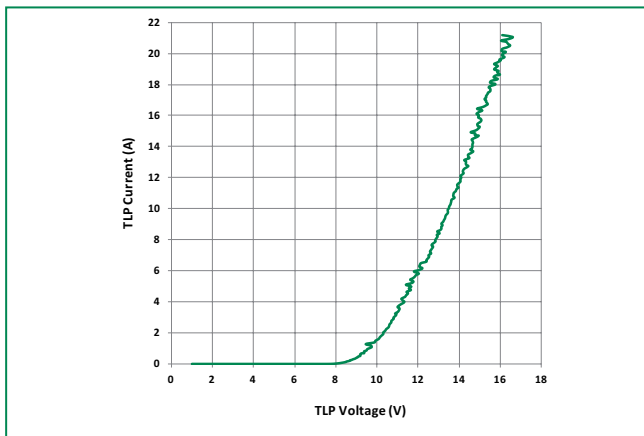

**SD12C Transmission Line Pulsing (TLP) Plot**

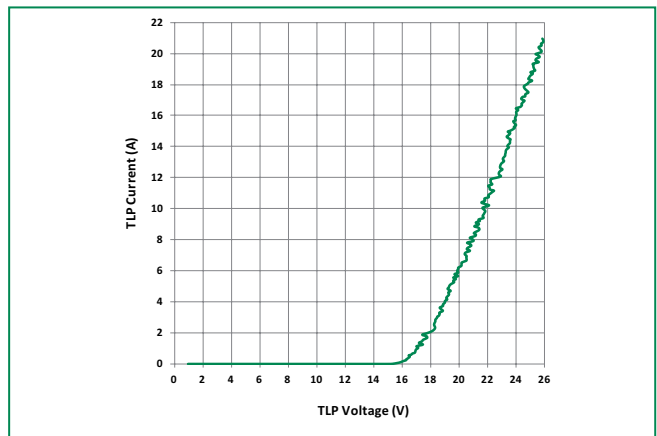

**SD15C Transmission Line Pulsing(TLP) Plot**

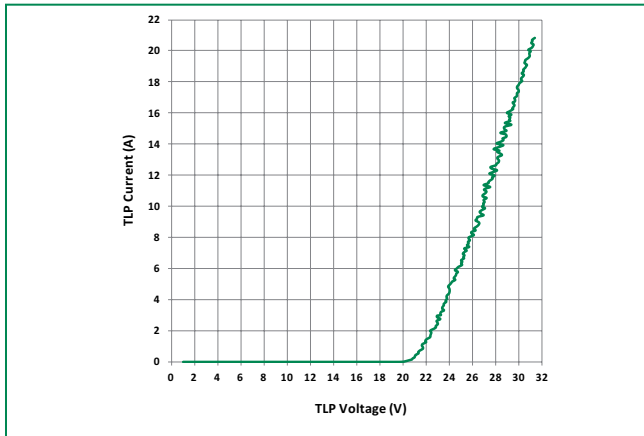

**SD24C Transmission Line Pulsing(TLP) Plot**

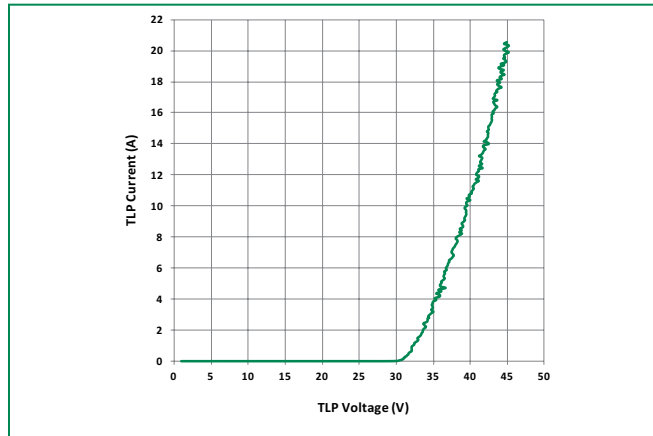

**SD36C Transmission Line Pulsing(TLP) Plot**

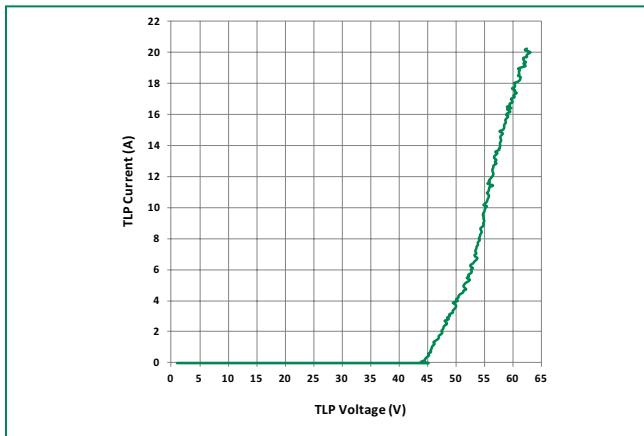

**Soldering Parameters**

Reflow Condition		Pb – Free assembly
Pre Heat	- Temperature Min ( $T_{s(min)}$ )	150°C
	- Temperature Max ( $T_{s(max)}$ )	200°C
	- Time (min to max) ( $t_s$ )	60 – 180 secs
Average ramp up rate (Liquidus) Temp ( $T_L$ ) to peak		3°C/second max
$T_{s(max)}$ to $T_L$ - Ramp-up Rate		3°C/second max
Reflow	- Temperature ( $T_L$ ) (Liquidus)	217°C
	- Temperature ( $t_L$ )	60 – 150 seconds
Peak Temperature ( $T_p$ )		260 <sup>+0/-5</sup> °C
Time within 5°C of actual peak Temperature ( $t_p$ )		20 – 40 seconds
Ramp-down Rate		6°C/second max
Time 25°C to peak Temperature ( $T_p$ )		8 minutes Max.
Do not exceed		260°C

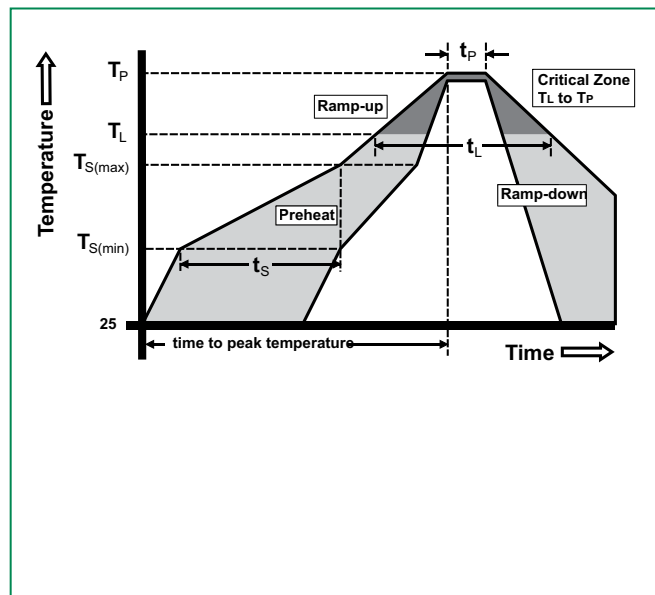

### Product Characteristics

<b>Lead Plating</b>	Matte Tin
<b>Lead Material</b>	Copper Alloy
<b>Lead Coplanarity</b>	0.0004 inches (0.102mm)
<b>Substrate material</b>	Silicon
<b>Body Material</b>	Molded Compound
<b>Flammability</b>	UL Recognized compound meeting flammability rating V-0

### Ordering Information

Part Number	Package	Min. Order Qty.
SD05C-01FTG	SOD323	3000
SD12C-01FTG	SOD323	3000
SD15C-01FTG	SOD323	3000
SD24C-01FTG	SOD323	3000
SD36C-01FTG	SOD323	3000

### Part Marking System

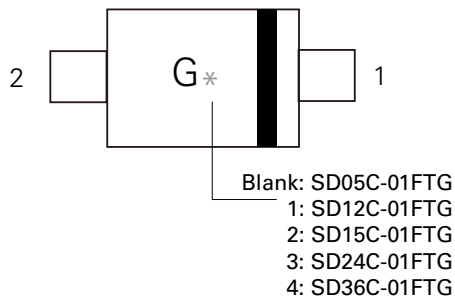

### Part Numbering System

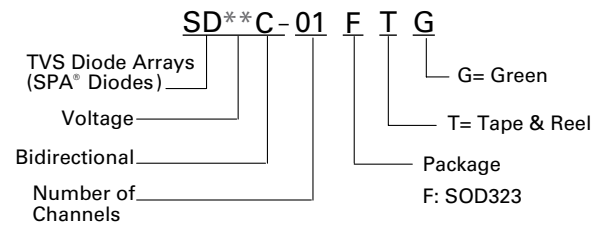

### Package Dimensions -SOD323

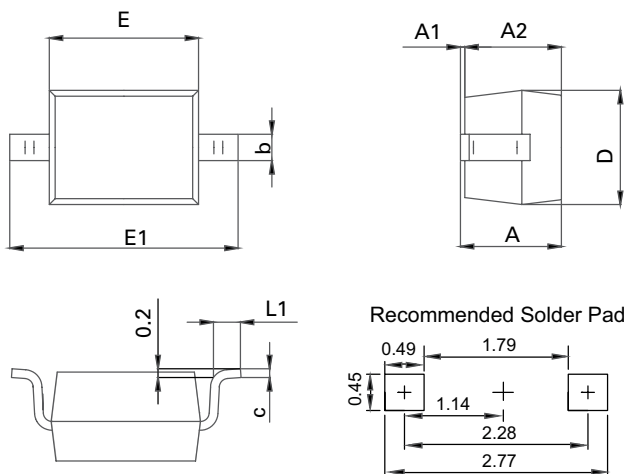

Unit: mm

Symbol	SOD323			
	Millimeters		Inches	
	Min	Max	Min	Max
<b>A</b>	0.8	1.14	0.031	0.045
<b>A1</b>	0.00	0.10	0.000	0.004
<b>A2</b>	0.80	1.04	0.031	0.014
<b>b</b>	0.25	0.35	0.010	0.014
<b>c</b>	0.08	0.15	0.003	0.006
<b>D</b>	1.15	1.45	0.045	0.057
<b>E</b>	1.60	1.90	0.063	0.075
<b>E1</b>	2.44	2.70	0.096	0.106
<b>L1</b>	0.25	0.45	0.010	0.018

**Embossed Carrier Tape & Reel Specification – SOD323**

