



Is Now Part of



ON Semiconductor®

To learn more about ON Semiconductor, please visit our website at
www.onsemi.com

Please note: As part of the Fairchild Semiconductor integration, some of the Fairchild orderable part numbers will need to change in order to meet ON Semiconductor's system requirements. Since the ON Semiconductor product management systems do not have the ability to manage part nomenclature that utilizes an underscore (_), the underscore (_) in the Fairchild part numbers will be changed to a dash (-). This document may contain device numbers with an underscore (_). Please check the ON Semiconductor website to verify the updated device numbers. The most current and up-to-date ordering information can be found at www.onsemi.com. Please email any questions regarding the system integration to Fairchild_questions@onsemi.com.

ON Semiconductor and the ON Semiconductor logo are trademarks of Semiconductor Components Industries, LLC dba ON Semiconductor or its subsidiaries in the United States and/or other countries. ON Semiconductor owns the rights to a number of patents, trademarks, copyrights, trade secrets, and other intellectual property. A listing of ON Semiconductor's product/patent coverage may be accessed at www.onsemi.com/site/pdf/Patent-Marking.pdf. ON Semiconductor reserves the right to make changes without further notice to any products herein. ON Semiconductor makes no warranty, representation or guarantee regarding the suitability of its products for any particular purpose, nor does ON Semiconductor assume any liability arising out of the application or use of any product or circuit, and specifically disclaims any and all liability, including without limitation special, consequential or incidental damages. Buyer is responsible for its products and applications using ON Semiconductor products, including compliance with all laws, regulations and safety requirements or standards, regardless of any support or applications information provided by ON Semiconductor. "Typical" parameters which may be provided in ON Semiconductor data sheets and/or specifications can and do vary in different applications and actual performance may vary over time. All operating parameters, including "Typicals" must be validated for each customer application by customer's technical experts. ON Semiconductor does not convey any license under its patent rights nor the rights of others. ON Semiconductor products are not designed, intended, or authorized for use as a critical component in life support systems or any FDA Class 3 medical devices or medical devices with a same or similar classification in a foreign jurisdiction or any devices intended for implantation in the human body. Should Buyer purchase or use ON Semiconductor products for any such unintended or unauthorized application, Buyer shall indemnify and hold ON Semiconductor and its officers, employees, subsidiaries, affiliates, and distributors harmless against all claims, costs, damages, and expenses, and reasonable attorney fees arising out of, directly or indirectly, any claim of personal injury or death associated with such unintended or unauthorized use, even if such claim alleges that ON Semiconductor was negligent regarding the design or manufacture of the part. ON Semiconductor is an Equal Opportunity/Affirmative Action Employer. This literature is subject to all applicable copyright laws and is not for resale in any manner.

FDC855N

Single N-Channel, Logic Level, PowerTrench® MOSFET 30V, 6.1A, 27mΩ

Features

- Max $r_{DS(on)}$ = 27mΩ at $V_{GS} = 10V$, $I_D = 6.1A$
- Max $r_{DS(on)}$ = 36mΩ at $V_{GS} = 4.5V$, $I_D = 5.3A$
- SuperSOT™ -6 package: small footprint (72% smaller than standard SO-8; low profile (1mm thick).
- RoHS Compliant



General Description

This N-Channel Logic Level MOSFET is an efficient solution for low voltage and battery powered applications. Utilizing Fairchild Semiconductor's advanced PowerTrench® process, this device possesses minimized on-state resistance to optimize the power consumption. They are ideal for applications where in-line power loss is critical.

Application

- Power Management in Notebook, Hard Disk Drive

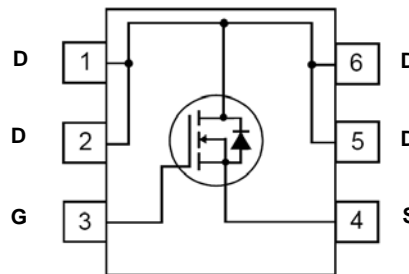
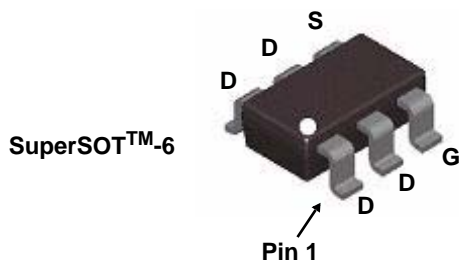

MOSFET Maximum Ratings $T_A = 25^\circ C$ unless otherwise noted

Symbol	Parameter	Rated	Units
V_{DS}	Drain to Source Voltage	30	V
V_{GS}	Gate to Source Voltage	±20	V
I_D	Drain Current -Continuous $T_A = 25^\circ C$ (Note 1a)	6.1	A
	-Pulsed	20	
P_D	Power Dissipation (Steady State) (Note 1a)	1.6	W
	Power Dissipation (Steady State) (Note 1b)	0.8	
T_J, T_{STG}	Operating and Storage Junction Temperature Range	-55 to +150	°C

Thermal Characteristics

$R_{\theta JC}$	Thermal Resistance, Junction to Case (Note 1)	30	°C/W
$R_{\theta JA}$	Thermal Resistance, Junction to Ambient (Note 1a)	78	

Package Marking and Ordering Information

Device Marking	Device	Package	Reel Size	Tape Width	Quantity
.855	FDC855N	SuperSOT-6	7"	8 mm	3000 units

Electrical Characteristics $T_J = 25^\circ\text{C}$ unless otherwise noted

Symbol	Parameter	Test Conditions	Min	Typ	Max	Units
BV_{DSS}	Drain to Source Breakdown Voltage	$I_D = 250\mu\text{A}, V_{GS} = 0\text{V}$	30			V
$\frac{\Delta BV_{DSS}}{\Delta T_J}$	Breakdown Voltage Temperature Coefficient	$I_D = 250\mu\text{A}$, referenced to 25°C		24		mV/ $^\circ\text{C}$
I_{DSS}	Zero Gate Voltage Drain Current	$V_{GS} = 0\text{V}, V_{DS} = 24\text{V}$, $T_C = 125^\circ\text{C}$			1 250	μA
I_{GSS}	Gate to Source Leakage Current	$V_{GS} = \pm 20\text{V}, V_{DS} = 0\text{V}$			± 100	nA

On Characteristics

$V_{GS(th)}$	Gate to Source Threshold Voltage	$V_{GS} = V_{DS}, I_D = 250\mu\text{A}$	1.0	2.0	3.0	V
$\frac{\Delta V_{GS(th)}}{\Delta T_J}$	Gate to Source Threshold Voltage Temperature Coefficient	$I_D = 250\mu\text{A}$, referenced to 25°C		-6		mV/ $^\circ\text{C}$
$r_{DS(on)}$	Static Drain to Source On Resistance	$V_{GS} = 10\text{V}, I_D = 6.1\text{A}$		20.7	27.0	m Ω
		$V_{GS} = 4.5\text{V}, I_D = 5.3\text{A}$		28.2	36.0	
		$V_{GS} = 10\text{V}, I_D = 6.1\text{A}, T_J = 125^\circ\text{C}$		30.1	39.3	
g_{FS}	Forward Transconductance	$V_{DD} = 10\text{V}, I_D = 6.1\text{A}$		20		S

Dynamic Characteristics

C_{iss}	Input Capacitance	$V_{DS} = 15\text{V}, V_{GS} = 0\text{V}$, $f = 1\text{MHz}$		493	655	pF
C_{oss}	Output Capacitance			108	145	pF
C_{rss}	Reverse Transfer Capacitance			62	95	pF
R_g	Gate Resistance	$f = 1\text{MHz}$		1.0		Ω

Switching Characteristics

$t_{d(on)}$	Turn-On Delay Time	$V_{DD} = 15\text{V}, I_D = 6.1\text{A}$, $V_{GS} = 10\text{V}, R_{GEN} = 6\Omega$		6	12	ns
t_r	Rise Time			2	10	ns
$t_{d(off)}$	Turn-Off Delay Time			14	23	ns
t_f	Fall Time			2	10	ns
Q_g	Total Gate Charge at 10V		$V_{GS} = 0\text{V to } 10\text{V}$	$V_{DD} = 15\text{V}$, $I_D = 6.1\text{A}$	9.2	13
Q_g	Total Gate Charge at 5V	$V_{GS} = 0\text{V to } 5\text{V}$	4.9		7.0	nC
Q_{gs}	Gate to Source Charge		1.7			nC
Q_{gd}	Gate to Drain "Miller" Charge		3.1			nC

Drain-Source Diode Characteristics

V_{SD}	Source to Drain Diode Forward Voltage	$V_{GS} = 0\text{V}, I_S = 1.3\text{A}$ (Note 2)		0.80	1.2	V
t_{rr}	Reverse Recovery Time	$I_F = 6.1\text{A}, di/dt = 100\text{A}/\mu\text{s}$		17	31	ns
Q_{rr}	Reverse Recovery Charge			6	12	nC

Notes:

1: $R_{\theta JA}$ is the sum of the junction-to-case and case-to-ambient thermal resistance where the case thermal reference is defined as the solder mounting surface of the drain pins. $R_{\theta JC}$ is guaranteed by design while $R_{\theta CA}$ is determined by the user's board design.



a. 78°C/W when mounted on a 1 in^2 pad of 2 oz copper.



b. 156°C/W when mounted on a minimum pad of 2 oz copper.

2: Pulse Test: Pulse Width < 300 μs , Duty Cycle < 2.0%.

Typical Characteristics $T_J = 25^\circ\text{C}$ unless otherwise noted

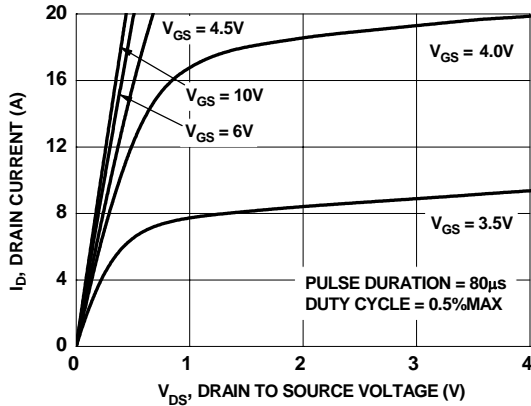

Figure 1. On-Region Characteristics

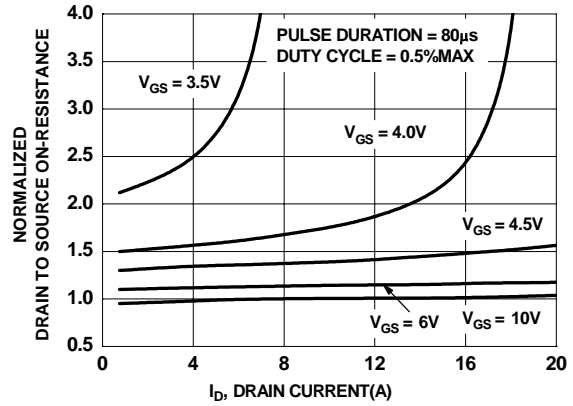

Figure 2. Normalized On-Resistance vs Drain Current and Gate Voltage

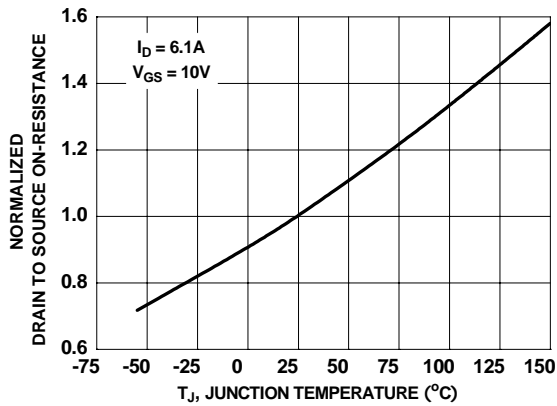

Figure 3. Normalized On-Resistance vs Junction Temperature

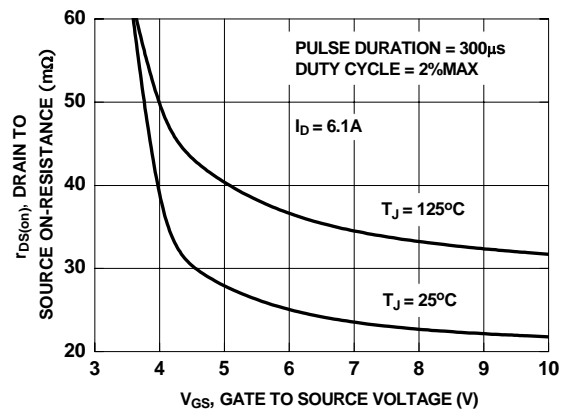

Figure 4. On-Resistance vs Gate to Source Voltage

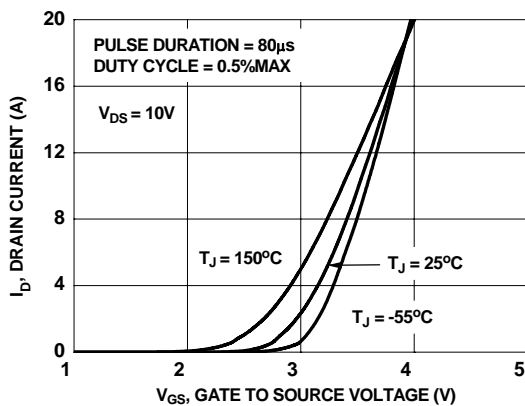

Figure 5. Transfer Characteristics

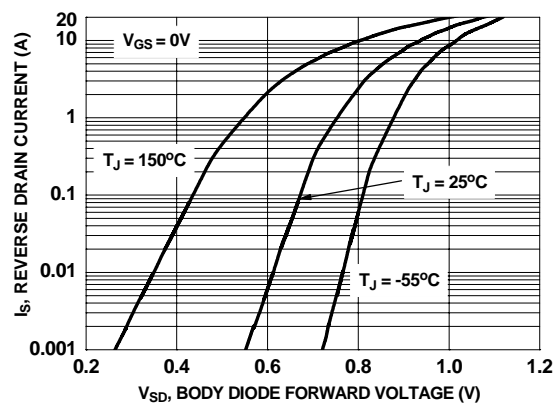

Figure 6. Source to Drain Diode Forward Voltage vs Source Current

Typical Characteristics $T_J = 25^\circ\text{C}$ unless otherwise noted

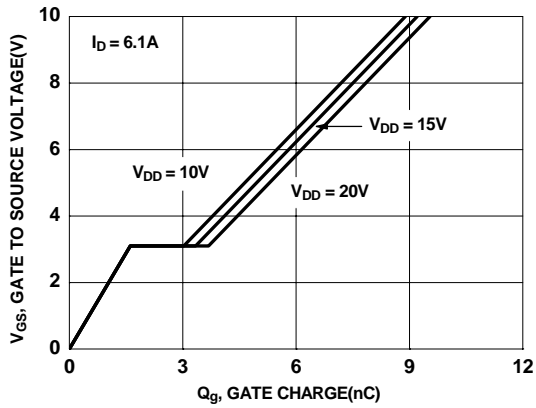

Figure 7. Gate Charge Characteristics

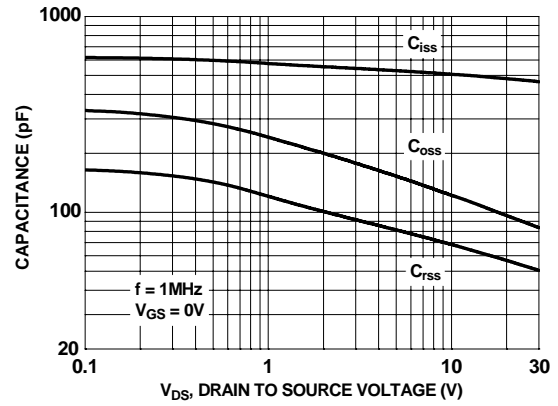

Figure 8. Capacitance vs Drain to Source Voltage

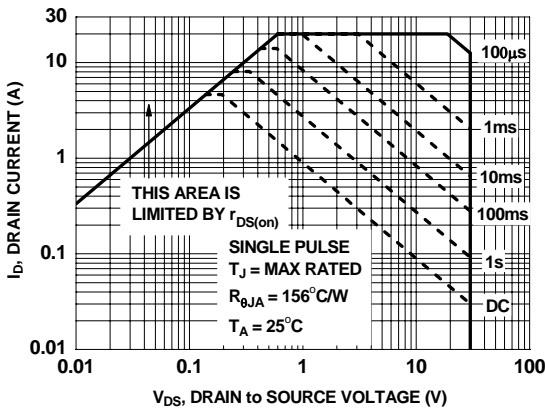

Figure 9. Forward Bias Safe Operating Area

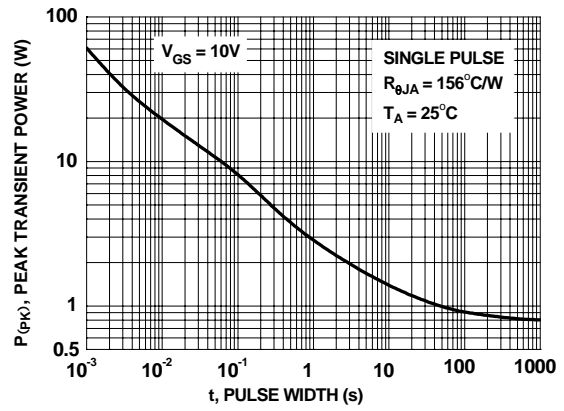

Figure 10. Single Pulse Maximum Power Dissipation

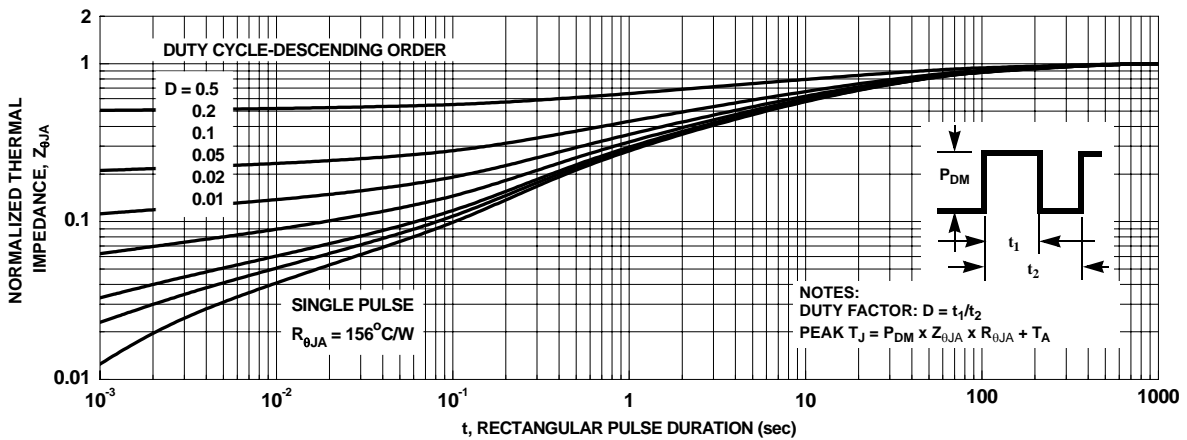
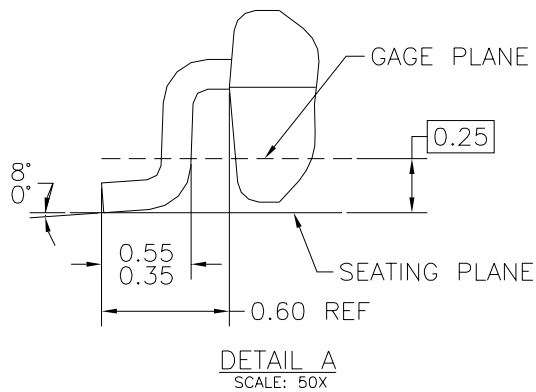
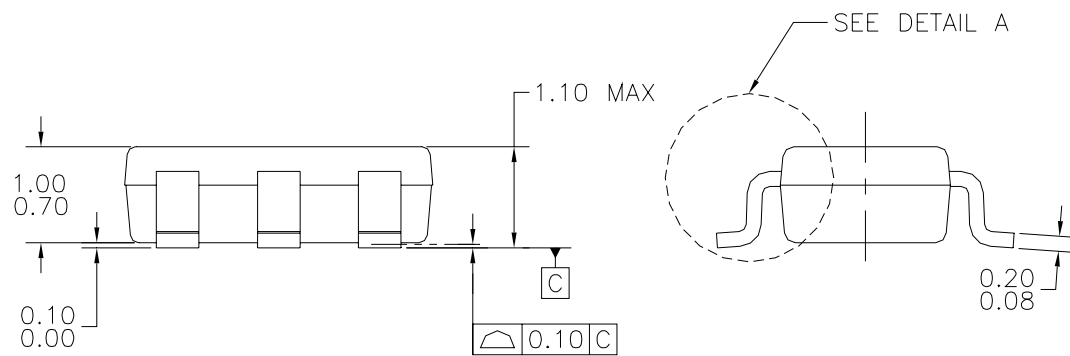
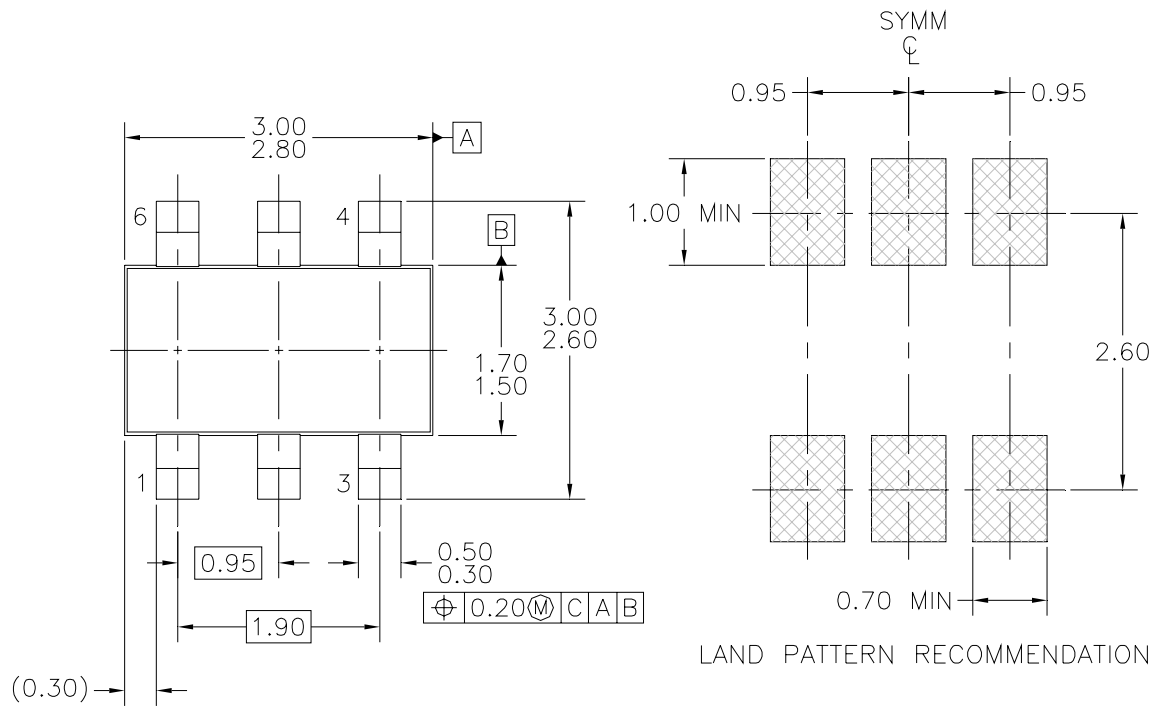

Figure 11. Transient Thermal Response Curve

Dimensional Outline and Pad Layout



NOTES: UNLESS OTHERWISE SPECIFIED





- A) THIS PACKAGE CONFORMS TO JEDEC MO-193. VAR. AA, ISSUE C, DATED JANUARY 2000.
- B) ALL DIMENSIONS ARE IN MILLIMETERS.

MA06AREVD

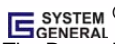

TRADEMARKS

The following includes registered and unregistered trademarks and service marks, owned by Fairchild Semiconductor and/or its global subsidiaries, and is not intended to be an exhaustive list of all such trademarks.

ACEx®	FPS™	PDP-SPM™	SupreMOS™
Build it Now™	FRFET®	Power220®	SyncFET™
CorePLUS™	Global Power Resource SM	POWEREDGE®	 SYSTEM GENERAL®
CROSSVOLT™	Green FPS™	Power-SPM™	The Power Franchise®
CTL™	Green FPS™ e-Series™	PowerTrench®	 the power franchise
Current Transfer Logic™	GTO™	Programmable Active Droop™	TinyBoost™
EcoSPARK®	<i>i-Lo</i> ™	QFET®	TinyBuck™
EZSWITCH™ *	IntelliMAX™	QS™	TinyLogic®
	ISOPLANAR™	QT Optoelectronics™	TINYOPTO™
	MegaBuck™	Quiet Series™	TinyPower™
Fairchild®	MICROCOUPLER™	RapidConfigure™	TinyPWM™
Fairchild Semiconductor®	MicroFET™	SMART START™	TinyWire™
FACT Quiet Series™	MicroPak™	SPM®	µSerDes™
FACT®	MillerDrive™	STEALTH™	UHC®
FAST®	Motion-SPM™	SuperFET™	Ultra FRFET™
FastvCore™	OPTOLOGIC®	SuperSOT™-3	UniFET™
FlashWriter® *	OPTOPLANAR®	SuperSOT™-6	VCX™
		SuperSOT™-8	

* EZSWITCH™ and FlashWriter® are trademarks of System General Corporation, used under license by Fairchild Semiconductor.

DISCLAIMER

FAIRCHILD SEMICONDUCTOR RESERVES THE RIGHT TO MAKE CHANGES WITHOUT NOTICE TO ANY PRODUCTS HEREIN TO IMPROVE RELIABILITY, FUNCTION, OR DESIGN. FAIRCHILD DOES NOT ASSUME ANY LIABILITY ARISING OUT OF THE APPLICATION OR USE OF ANY PRODUCT OR CIRCUIT DESCRIBED HEREIN; NEITHER DOES IT CONVEY ANY LICENSE UNDER ITS PATENT RIGHTS, NOR THE RIGHTS OF OTHERS. THESE SPECIFICATIONS DO NOT EXPAND THE TERMS OF FAIRCHILD'S WORLDWIDE TERMS AND CONDITIONS, SPECIFICALLY THE WARRANTY THEREIN, WHICH COVERS THESE PRODUCTS.

LIFE SUPPORT POLICY

FAIRCHILD'S PRODUCTS ARE NOT AUTHORIZED FOR USE AS CRITICAL COMPONENTS IN LIFE SUPPORT DEVICES OR SYSTEMS WITHOUT THE EXPRESS WRITTEN APPROVAL OF FAIRCHILD SEMICONDUCTOR CORPORATION.

As used herein:

- Life support devices or systems are devices or systems which, (a) are intended for surgical implant into the body or (b) support or sustain life, and (c) whose failure to perform when properly used in accordance with instructions for use provided in the labeling, can be reasonably expected to result in a significant injury to the user.
- A critical component in any component of a life support, device or system whose failure to perform can be reasonably expected to cause the failure of the life support device or system, or to affect its safety or effectiveness.

PRODUCT STATUS DEFINITIONS

Definition of Terms

Datasheet Identification	Product Status	Definition
Advance Information	Formative or In Design	This datasheet contains the design specifications for product development. Specifications may change in any manner without notice.
Preliminary	First Production	This datasheet contains preliminary data; supplementary data will be published at a later date. Fairchild Semiconductor reserves the right to make changes at any time without notice to improve design.
No Identification Needed	Full Production	This datasheet contains final specifications. Fairchild Semiconductor reserves the right to make changes at any time without notice to improve design.
Obsolete	Not In Production	This datasheet contains specifications on a product that has been discontinued by Fairchild Semiconductor. The datasheet is printed for reference information only.

Rev. I33

ON Semiconductor and  are trademarks of Semiconductor Components Industries, LLC dba ON Semiconductor or its subsidiaries in the United States and/or other countries. ON Semiconductor owns the rights to a number of patents, trademarks, copyrights, trade secrets, and other intellectual property. A listing of ON Semiconductor's product/patent coverage may be accessed at www.onsemi.com/site/pdf/Patent-Marking.pdf. ON Semiconductor reserves the right to make changes without further notice to any products herein. ON Semiconductor makes no warranty, representation or guarantee regarding the suitability of its products for any particular purpose, nor does ON Semiconductor assume any liability arising out of the application or use of any product or circuit, and specifically disclaims any and all liability, including without limitation special, consequential or incidental damages. Buyer is responsible for its products and applications using ON Semiconductor products, including compliance with all laws, regulations and safety requirements or standards, regardless of any support or applications information provided by ON Semiconductor. "Typical" parameters which may be provided in ON Semiconductor data sheets and/or specifications can and do vary in different applications and actual performance may vary over time. All operating parameters, including "Typicals" must be validated for each customer application by customer's technical experts. ON Semiconductor does not convey any license under its patent rights nor the rights of others. ON Semiconductor products are not designed, intended, or authorized for use as a critical component in life support systems or any FDA Class 3 medical devices or medical devices with a same or similar classification in a foreign jurisdiction or any devices intended for implantation in the human body. Should Buyer purchase or use ON Semiconductor products for any such unintended or unauthorized application, Buyer shall indemnify and hold ON Semiconductor and its officers, employees, subsidiaries, affiliates, and distributors harmless against all claims, costs, damages, and expenses, and reasonable attorney fees arising out of, directly or indirectly, any claim of personal injury or death associated with such unintended or unauthorized use, even if such claim alleges that ON Semiconductor was negligent regarding the design or manufacture of the part. ON Semiconductor is an Equal Opportunity/Affirmative Action Employer. This literature is subject to all applicable copyright laws and is not for resale in any manner.

PUBLICATION ORDERING INFORMATION

LITERATURE FULFILLMENT:

Literature Distribution Center for ON Semiconductor
19521 E. 32nd Pkwy, Aurora, Colorado 80011 USA
Phone: 303-675-2175 or 800-344-3860 Toll Free USA/Canada
Fax: 303-675-2176 or 800-344-3867 Toll Free USA/Canada
Email: orderlit@onsemi.com

N. American Technical Support: 800-282-9855 Toll Free
USA/Canada
Europe, Middle East and Africa Technical Support:
Phone: 421 33 790 2910
Japan Customer Focus Center
Phone: 81-3-5817-1050

ON Semiconductor Website: www.onsemi.com
Order Literature: <http://www.onsemi.com/orderlit>
For additional information, please contact your local
Sales Representative

Mouser Electronics

Authorized Distributor

Click to View Pricing, Inventory, Delivery & Lifecycle Information:

[ON Semiconductor:](#)

[FDC855N](#)