

THIS DRAWING IS UNPUBLISHED. RELEASED FOR PUBLICATION 20
 © COPYRIGHT 20 BY - ALL RIGHTS RESERVED.

LOC		DIST		REVISIONS			
ES	00	P	LYR	DESCRIPTION	DATE	DWN	APVD
		A7		ECR-15-010757	20JUL2015	SL	RR
		A8		ECR-17-010693	24JUL2017	WW	RR
		A9		ECR-18-007518	16MAY2018	WW	FL
		A10		ECR-18-007702	27MAY2018	WW	FL

NOTE

- 1 SEE SHEET 4 FOR AVAILABLE CONFIGURATIONS
- 2 MATERIAL: HOUSING, NYLON, UL94 V0, 750°C GWT NO FLAME
EIGHT COLORS AVAILABLE, INCLUDING: NATURAL, RED, BLUE, YELLOW, BLACK, GREY, GREEN, PURPLE
WHITE VERSION IS PRELIMINARY
CONTACT, COPPER ALLOY, 0.60MM THICK
- 3 FINISH: OPTION 1: TIN PLATING OVER NICKEL UNDERPLATING
OPTION 2: AG PLATING OVER NICKEL UNDERPLATING
- 4 PCB LAYOUT AS SHOWN

△5 THE PART NUMBERS SHOWING IN SHEET 2 & 3 & 4 ARE FOR NATURAL COLOR. THE PART NUMBER FOR OTHER COLOR ARE BASED ON THE NATURAL ONE. FOR THE SAME CONFIGURATION, THE PREFIX AND POSTFIX OF THE P/N ARE THE SAME, ONLY THE BASE NUMBER IS DIFFERENT ACCORDING TO DIFFERENT COLOR, DETAIL PLEASE SEE SHEET 5

△6 PACKAGING: LOOSE PIECE OR TUBE. THE PART NUMBERS IN THIS DRAWING ARE WITH LOOSE PIECE PACKAGING EXCEPT THE PN 1-2322471-3. PLEASE CONTACT TE SALES REPRESENTATIVES FOR TUBE PACKAGING REQUIREMENT.

△7 FOR PN 7-1971817-5 PIN LAYOUT AS FOLLOW

△8 PRELIMINARY PART NOT RELEASED FOR PRODUCTION

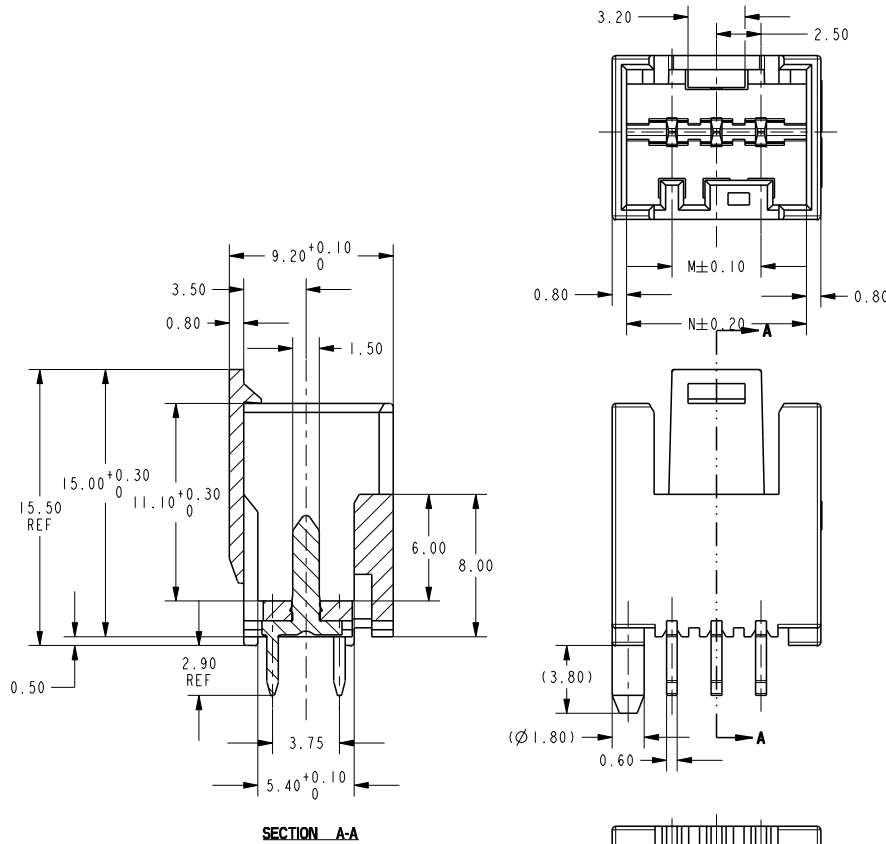
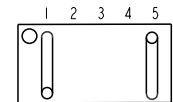

SECTION A-A

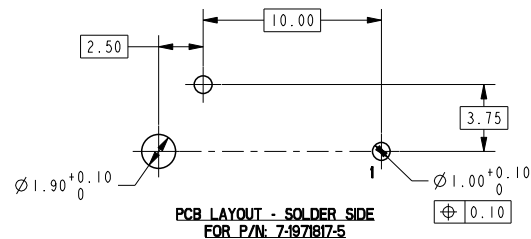
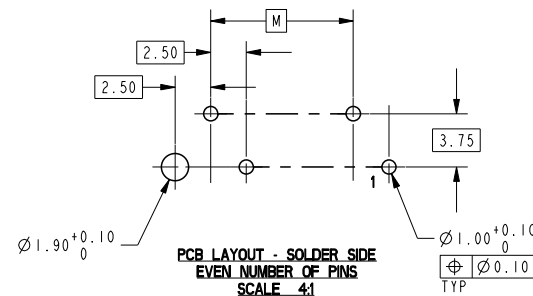
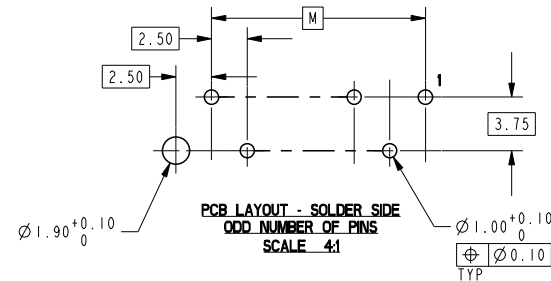

N	M	NO. OF POS.
40.10	35.00	15
37.60	32.50	14
35.10	30.00	13
32.60	27.50	12
30.10	25.00	11
27.60	22.50	10
25.10	20.00	9
22.60	17.50	8
20.10	15.00	7
17.60	12.50	6
15.10	10.00	5
12.60	7.50	4
10.10	5.00	3

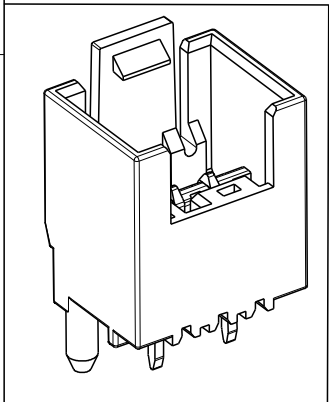

THIS DRAWING IS A CONTROLLED DOCUMENT. DWN: WINTER WANG 12NOV2012
 CHK: HAPYE WU 12NOV2012
 APVD: YI HONG MAO 12NOV2012

TE Connectivity
TE
 NAME: RAST 2.5 TAB HEADER ASSY TH, VERTICAL, EXTERNAL LOCKING
 PRODUCT SPEC: 108-106079
 APPLICATION SPEC: -
 SIZE: A2 CAGE CODE: 00779 DRAWING NO: ©=1971817
 RESTRICTED TO: -
 WEIGHT: -
 CUSTOMER DRAWING SCALE: 5:1 SHEET 1 OF 5 REV: A10

4

3

2

1

THIS DRAWING IS UNPUBLISHED. RELEASED FOR PUBLICATION 20
COPYRIGHT 20 BY - ALL RIGHTS RESERVED.

LOC	DIST	REVISIONS					
ES	00	P	LYR	DESCRIPTION	DATE	DWN	APVD

QTY	TAB CONTACT	QTY	HOUSING	POS.	TE PART NO.
15	TAB CONTACT w/ SILVER PLATING	I	RAST 2.5 TAB HEADER HOUSING, EXTERNAL LOCKING, 15P (SEE THE DETAIL LAYOUT ON SHEET 4)	15	3-1971838-5 2-1971838-5 1-1971838-5
9		I	RAST 2.5 TAB HEADER HOUSING, EXTERNAL LOCKING, 14P (SEE THE DETAIL LAYOUT ON SHEET 4)	14	2-1971838-4 1-1971838-4
14		I	RAST 2.5 TAB HEADER HOUSING, EXTERNAL LOCKING, 13P (SEE THE DETAIL LAYOUT ON SHEET 4)	13	1-1971838-3
13		I	RAST 2.5 TAB HEADER HOUSING, EXTERNAL LOCKING, 13P (SEE THE DETAIL LAYOUT ON SHEET 4)	13	1-1971838-3
8		I	RAST 2.5 TAB HEADER HOUSING, EXTERNAL LOCKING, 12P (SEE THE DETAIL LAYOUT ON SHEET 4)	12	2-1971838-2 1-1971838-2
12		I	RAST 2.5 TAB HEADER HOUSING, EXTERNAL LOCKING, 12P (SEE THE DETAIL LAYOUT ON SHEET 4)	12	2-1971838-2 1-1971838-2
11		I	RAST 2.5 TAB HEADER HOUSING, EXTERNAL LOCKING, 11P (SEE THE DETAIL LAYOUT ON SHEET 4)	11	2-1971838-1 1-1971838-1

QTY	TAB CONTACT	QTY	HOUSING	POS.	TE PART NO.
10	TAB CONTACT w/ SILVER PLATING	I	RAST 2.5 TAB HEADER HOUSING, EXTERNAL LOCKING, 10P (SEE THE DETAIL LAYOUT ON SHEET 4)	10	3-1971837-0 2-1971837-0 1-1971837-0
9		I	RAST 2.5 TAB HEADER HOUSING, EXTERNAL LOCKING, 9P (SEE THE DETAIL LAYOUT ON SHEET 4)	9	7-1971837-9 6-1971837-9 5-1971837-9 4-1971837-9 3-1971837-9 2-1971837-9 1-1971837-9
6		I	RAST 2.5 TAB HEADER HOUSING, EXTERNAL LOCKING, 8P (SEE THE DETAIL LAYOUT ON SHEET 4)	8	5-1971837-8 4-1971837-8 3-1971837-8 2-1971837-8 1-1971837-8
9		I	RAST 2.5 TAB HEADER HOUSING, EXTERNAL LOCKING, 8P (SEE THE DETAIL LAYOUT ON SHEET 4)	8	7-1971837-7 6-1971837-7 5-1971837-7 4-1971837-7 3-1971837-7 2-1971837-7 1-1971837-7
8		I	RAST 2.5 TAB HEADER HOUSING, EXTERNAL LOCKING, 8P (SEE THE DETAIL LAYOUT ON SHEET 4)	8	4-1971837-6 3-1971837-6 2-1971837-6 1-1971837-6
6		I	RAST 2.5 TAB HEADER HOUSING, EXTERNAL LOCKING, 7P (SEE THE DETAIL LAYOUT ON SHEET 4)	7	4-1971837-5 3-1971837-5 2-1971837-5 1-1971837-5
7		I	RAST 2.5 TAB HEADER HOUSING, EXTERNAL LOCKING, 7P (SEE THE DETAIL LAYOUT ON SHEET 4)	7	7-1971837-4 6-1971837-4 5-1971837-4 4-1971837-4 3-1971837-4 2-1971837-4 1-1971837-4
6		I	RAST 2.5 TAB HEADER HOUSING, EXTERNAL LOCKING, 6P (SEE THE DETAIL LAYOUT ON SHEET 4)	6	1971837-3 9-1971837-3 8-1971837-3 7-1971837-3 6-1971837-3 5-1971837-3 4-1971837-3 3-1971837-3
5		I	RAST 2.5 TAB HEADER HOUSING, EXTERNAL LOCKING, 5P (SEE THE DETAIL LAYOUT ON SHEET 4)	5	2-1971837-3 1-1971837-3
4		I	RAST 2.5 TAB HEADER HOUSING, EXTERNAL LOCKING, 4P (SEE THE DETAIL LAYOUT ON SHEET 4)	4	1-1971837-3

THIS DRAWING IS A CONTROLLED DOCUMENT. DWN: WINTER WANG 12NOV2012
CHK: HAPYE WU 12NOV2012
APVD: YIYHONG MAO 12NOV2012

TE Connectivity
NAME: RAST 2.5 TAB HEADER ASSY TH, VERTICAL, EXTERNAL LOCKING

PRODUCT SPEC: -
APPLICATION SPEC: -
WEIGHT: -
CUSTOMER DRAWING

DIMENSIONS: (mm)
TOLERANCES UNLESS OTHERWISE SPECIFIED:
0 PLC ±
1 PLC ±
2 PLC ±0.20
3 PLC ±
4 PLC ±
ANGLES ±
FINISH

SIZE: A2
CAGE CODE: 00779
DRAWING NO: ©=1971817
SCALE: 5:1
SHEET: 2 of 5
REV: A10

4

3

2

1

THIS DRAWING IS UNPUBLISHED. RELEASED FOR PUBLICATION 20
BY - ALL RIGHTS RESERVED.

LOC	DIST	REVISIONS			
P	LYR	DESCRIPTION	DATE	DWN	APVD
ES	00				

QTY	TAB CONTACT	QTY	HOUSING	POS.	TE PART NO.									
10	TAB CONTACT w/ TIN PLATING	I	RAST 2.5 TAB HEADER HOUSING, EXTERNAL LOCKING, 10P (SEE THE DETAIL LAYOUT ON SHEET 4)	10	3-1971817-0 2-1971817-0 1-1971817-0									
9		I	RAST 2.5 TAB HEADER HOUSING, EXTERNAL LOCKING, 9P (SEE THE DETAIL LAYOUT ON SHEET 4)	9	7-1971817-9 6-1971817-9 5-1971817-9 4-1971817-9 3-1971817-9 2-1971817-9 1-1971817-9									
6					I	RAST 2.5 TAB HEADER HOUSING, EXTERNAL LOCKING, 8P (SEE THE DETAIL LAYOUT ON SHEET 4)	8	5-1971817-8 4-1971817-8 3-1971817-8 2-1971817-8 1-1971817-8						
9								I	RAST 2.5 TAB HEADER HOUSING, EXTERNAL LOCKING, 7P (SEE THE DETAIL LAYOUT ON SHEET 4)	7	7-1971817-7 6-1971817-7 5-1971817-7 4-1971817-7 3-1971817-7 2-1971817-7 1-1971817-7			
8											I	RAST 2.5 TAB HEADER HOUSING, EXTERNAL LOCKING, 6P (SEE THE DETAIL LAYOUT ON SHEET 4)	6	4-1971817-6 3-1971817-6 2-1971817-6 1-1971817-6
6					I	RAST 2.5 TAB HEADER HOUSING, EXTERNAL LOCKING, 5P (SEE THE DETAIL LAYOUT ON SHEET 4)	5							7-1971817-5 6-1971817-5 4-1971817-5 3-1971817-5 2-1971817-5 1-1971817-5
2														I
5								I	RAST 2.5 TAB HEADER HOUSING, EXTERNAL LOCKING, 3P (SEE THE DETAIL LAYOUT ON SHEET 4)	3				
7		7-1971817-5 6-1971817-5												
6		7-1971817-5 6-1971817-5												
5		7-1971817-4 6-1971817-4												
4		7-1971817-4 6-1971817-4												
3		7-1971817-4 6-1971817-4												
2		7-1971817-4 6-1971817-4												
1		7-1971817-4 6-1971817-4												
1		7-1971817-4 6-1971817-4												
1		7-1971817-4 6-1971817-4												



15	TAB CONTACT w/ TIN PLATING	I	RAST 2.5 TAB HEADER HOUSING, EXTERNAL LOCKING, 15P (SEE THE DETAIL LAYOUT ON SHEET 4)	15	3-1971818-5 2-1971818-5 1-1971818-5			
9		I	RAST 2.5 TAB HEADER HOUSING, EXTERNAL LOCKING, 14P (SEE THE DETAIL LAYOUT ON SHEET 4)	14	2-1971818-4			
14		I	RAST 2.5 TAB HEADER HOUSING, EXTERNAL LOCKING, 13P (SEE THE DETAIL LAYOUT ON SHEET 4)	13	1-1971818-4			
13					1-1971818-3			
8					I	RAST 2.5 TAB HEADER HOUSING, EXTERNAL LOCKING, 12P (SEE THE DETAIL LAYOUT ON SHEET 4)	12	2-1971818-2 1-1971818-2
12		I	RAST 2.5 TAB HEADER HOUSING, EXTERNAL LOCKING, 11P (SEE THE DETAIL LAYOUT ON SHEET 4)	11				2-1971818-1 1-1971818-1
11								2-1971818-1 1-1971818-1
QTY		TAB CONTACT	QTY	HOUSING				POS.

THIS DRAWING IS A CONTROLLED DOCUMENT.

DWN: WINTER WANG 12NOV2012
CHK: HAPYE WU 12NOV2012
APVD: YIYHONG MAO 12NOV2012

TE Connectivity

NAME: RAST 2.5 TAB HEADER ASSY TH, VERTICAL, EXTERNAL LOCKING

PRODUCT SPEC: -
APPLICATION SPEC: -
WEIGHT: -
CUSTOMER DRAWING

DIMENSIONS: (mm)
TOLERANCES UNLESS OTHERWISE SPECIFIED:
0 PLC ±
1 PLC ±
2 PLC ±0.20
3 PLC ±
4 PLC ±
ANGLES ±1°
FINISH

SIZE: A2
CAGE CODE: 00779
DRAWING NO: ©=1971817
SCALE: 5:1
SHEET: 3 OF 5
REV: A10

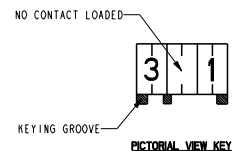
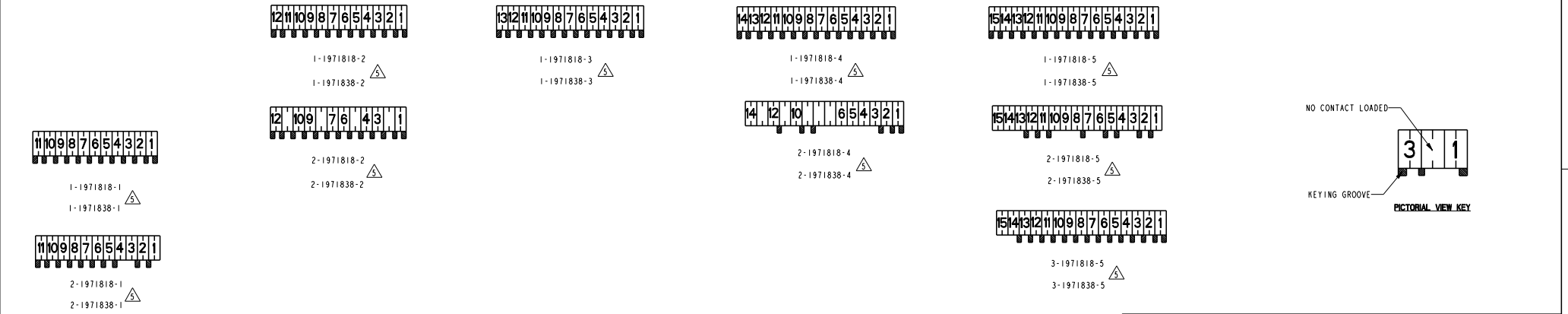
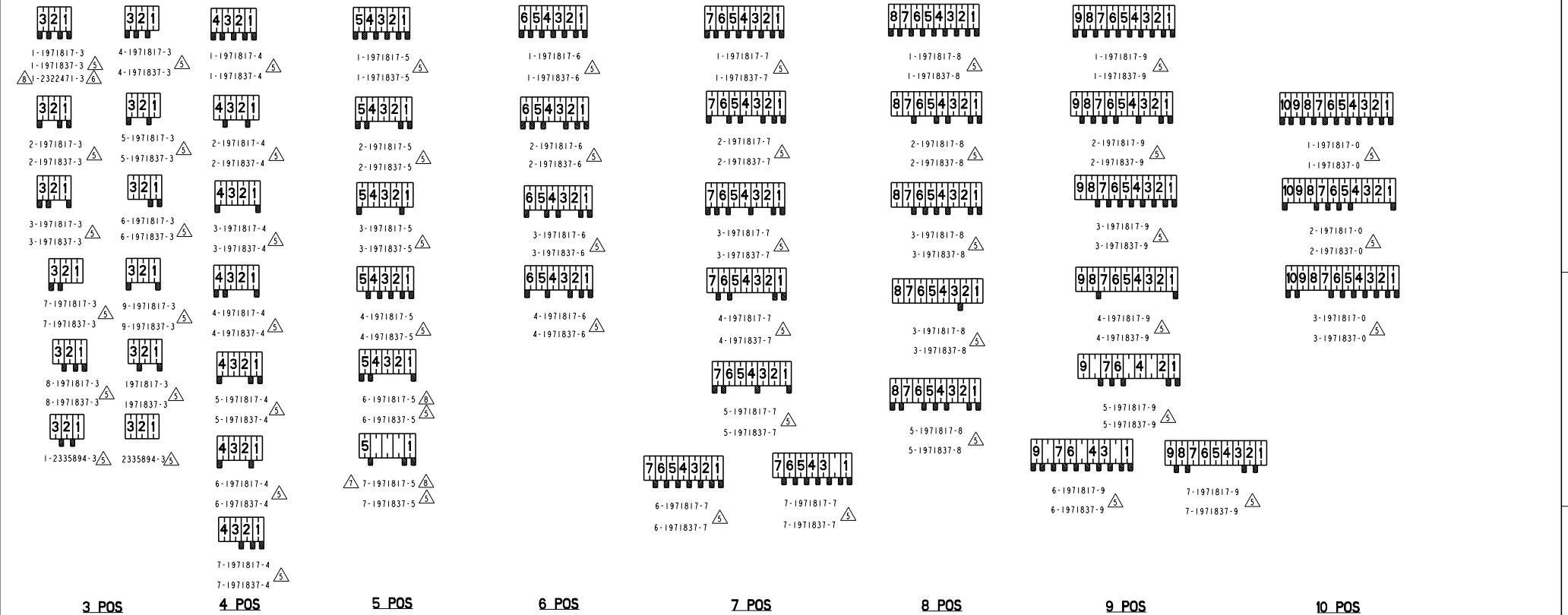

4

3

2

1

THIS DRAWING IS UNPUBLISHED. RELEASED FOR PUBLICATION 20
 © COPYRIGHT 20 BY - ALL RIGHTS RESERVED.

LOC	DIST	REVISIONS			
P	LYR	DESCRIPTION	DATE	DWN	APVD
ES	00				

FOR ANY KEYING CONFIGURATION, THERE ARE EIGHT COLORS AVAILABLE, BESIDES THE NATURAL COLOR, THERE ARE OTHER SEVEN COLORS, INCLUDE: YELLOW, BLUE, GREY, PURPLE, RED, GREEN, BLACK. THE WHITE VERSION IS PRELIMINARY. THE P/N OF THE COLOR CONNECTOR ARE BASED ON THE NATURAL CONNECTOR, THE PREFIX AND POSTFIX ARE THE SAME FOR THE SAME KEYING CONFIGURATION, BUT THE BASE NUMBERS ARE DIFFERENT ACCORDING TO DIFFERENT COLOR. THE FOLLOWING SHOWS WHAT'S THE P/N FOR COLOR CONNECTOR

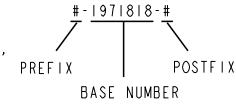

COLOR	PART NUMBER OF THE CONNECTOR				COMMENTS
	WITH TIN PLATING CONTACT		WITH AG PLATING CONTACT		
NATURAL	#-1971817-#	#-1971818-#	#-1971837-#	#-1971838-#	THE DETAIL P/N FOR DIFFERENT KEYING SEE SHEET 2 & 3 & 4
RED	#-1971938-#	#-1971939-#	#-2232141-#	#-2232142-#	THE PREFIX AND POSTFIX ARE THE SAME WITH THE P/N OF THE NATURAL CONNECTOR FOR THE SAME KEYING CONFIGURATION, JUST THE BASE NUMBERS ARE DIFFERENT BASED ON DIFFERENT COLOR. # CAN BE THE NUMBER FROM 0 TO 9.
BLUE	#-2232143-#	#-2232144-#	#-2232145-#	#-2232146-#	
YELLOW	#-2232147-#	#-2232148-#	#-2232149-#	#-2232150-#	
BLACK	#-1971994-#	#-1971995-#	#-2232151-#	#-2232152-#	
GREY	#-1971976-#	#-1971977-#	#-2232153-#	#-2232154-#	
GREEN	#-1971988-#	#-1971989-#	#-2232155-#	#-2232156-#	
PURPLE	#-2232157-#	#-2232158-#	#-2232159-#	#-2232160-#	
WHITE	#-2232277-#	#-2232278-#	#-2232279-#	#-2232280-#	

FOR EXAMPLE, IF A CONNECTOR WITH THE CONFIGURATION AS BELOW, AND WITH TIN PLATING CONTACT, IN THE SHEET 4, WE CAN FIND THE RELATED CONNECTOR P/N WITH NATURAL COLOR IS 5-1971817-4, THEN WE CAN LOOK IN THE ABOVE TABLE TO FIND THE CONNECTOR P/N WITH RED COLOR IS 5-1971938-4



THIS DRAWING IS A CONTROLLED DOCUMENT.		DWN: WINTER WANG 12NOV2012	TE Connectivity	
DIMENSIONS: (mm)		CHK: HAPYE WU 12NOV2012		
TOLERANCES UNLESS OTHERWISE SPECIFIED:		APVD: YI HONG MAO 12NOV2012	NAME: RAST 2.5 TAB HEADER ASSY TH, VERTICAL, EXTERNAL LOCKING	
0 PLC ±- 1 PLC ±- 2 PLC ±0.20 3 PLC ±- 4 PLC ±- ANGLES ±1° FINISH		PRODUCT SPEC: 108-106079	SIZE: A2	
MATERIAL: -		APPLICATION SPEC: -	CAGE CODE: 00779	DRAWING NO: ©=1971817
		WEIGHT: -	RESTRICTED TO: -	
		CUSTOMER DRAWING	SCALE: 5:1	SHEET 5 OF 5 REV: A10

Mouser Electronics

Authorized Distributor

Click to View Pricing, Inventory, Delivery & Lifecycle Information:

[TE Connectivity:](#)

[1-1971837-9](#)