

Features

- One differential (LVPECL, LVDS, HCSL, or CML) input pair distributed to two LVPECL output pairs
- Translates any single-ended input signal to 3.3 V LVPECL levels with resistor bias on INx# input
- 20-ps maximum output-to-output skew
- 480-ps maximum propagation delay
- 0.15-ps maximum additive RMS phase jitter at 156.25 MHz (12-kHz to 20-MHz offset)
- Up to 1.5-GHz operation
- 8-pin SOIC or 8-pin TSSOP package
- 2.5-V or 3.3-V operating voltage ^[1]
- Commercial and industrial operating temperature range

Functional Description

The CY2DP1502 is an ultra-low noise, low-skew, low-propagation delay 1:2 LVPECL fanout buffer targeted to meet the requirements of high-speed clock distribution applications. The device has a fully differential internal architecture that is optimized to achieve low additive jitter and low skew at operating frequencies of up to 1.5 GHz.

For a complete list of related documentation, [click here](#).

Logic Block Diagram

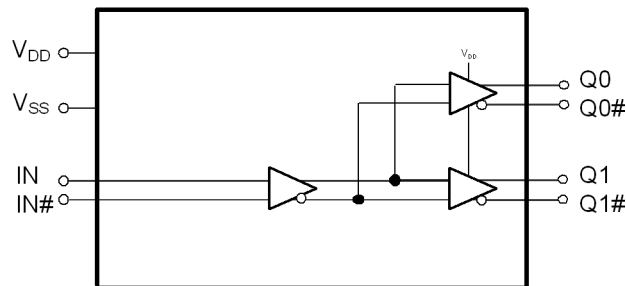

Note

1. Input AC-coupling capacitors are required for voltage-translation applications.

Contents

Pinouts	3	Package Diagrams	12
Pin Definitions	3	Acronyms	14
Absolute Maximum Ratings	4	Document Conventions	14
Operating Conditions	4	Units of Measure	14
DC Electrical Specifications	5	Document History Page	15
Thermal Resistance	5	Sales, Solutions, and Legal Information	18
AC Electrical Specifications	6	Worldwide Sales and Design Support	18
Switching Waveforms	8	Products	18
Application Information	10	PSoC® Solutions	18
Ordering Information	11	Cypress Developer Community	18
Ordering Code Definitions	11	Technical Support	18

Pinouts

Figure 1. 8-pin SOIC and 8-pin TSSOP pinout

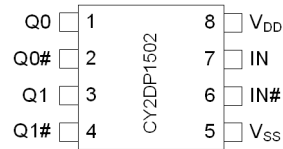

Pin Definitions

Pin Number	Pin Name	Pin Type	Description
1, 3	Q(0:1)	Output	LVPECL output clocks
2, 4	Q(0:1)#	Output	LVPECL complementary output clocks
5	V _{SS}	Power	Ground
6	IN#	Input	Differential (LVPECL, LVDS, HCSL, or CML) complementary input clock
7	IN	Input	Differential (LVPECL, LVDS, HCSL, or CML) input clock
8	V _{DD}	Power	Power supply

Absolute Maximum Ratings

Parameter	Description	Condition	Min	Max	Unit
V_{DD}	Supply voltage	Nonfunctional	-0.5	4.6	V
$V_{IN}^{[2]}$	Input voltage, relative to V_{SS}	Nonfunctional	-0.5	lesser of 4.0 or $V_{DD} + 0.4$	V
$V_{OUT}^{[2]}$	DC output or I/O voltage, relative to V_{SS}	Nonfunctional	-0.5	lesser of 4.0 or $V_{DD} + 0.4$	V
T_S	Storage temperature	Nonfunctional	-55	150	°C
ESD_{HBM}	Electrostatic discharge (ESD) protection (Human body model)	JEDEC STD 22-A114-B	2000	-	V
L_U	Latch-up	Meets or exceeds JEDEC Spec JESD78B IC Latch-up Test	-	-	
UL-94	Flammability rating	At 1/8 in		V-0	
MSL	Moisture sensitivity level	-		3	

Operating Conditions

Parameter	Description	Condition	Min	Max	Unit
V_{DD}	Supply voltage	2.5-V supply	2.375	2.625	V
		3.3-V supply	3.135	3.465	V
T_A	Ambient operating temperature	Commercial	0	70	°C
		Industrial	-40	85	°C
t_{PU}	Power ramp time	Power-up time for V_{DD} to reach minimum specified voltage (power ramp must be monotonic).	0.05	500	ms

Note

2. The voltage on any I/O pin cannot exceed the power pin during power-up. Power supply sequencing is NOT required.

DC Electrical Specifications

($V_{DD} = 3.3\text{ V} \pm 5\%$ or $2.5\text{ V} \pm 5\%$; $T_A = 0\text{ }^\circ\text{C}$ to $70\text{ }^\circ\text{C}$ (Commercial) or $-40\text{ }^\circ\text{C}$ to $85\text{ }^\circ\text{C}$ (Industrial))

Parameter	Description	Condition	Min	Max	Unit
I_{DD}	Operating supply current	All LVPECL outputs floating (internal I_{DD})	–	45	mA
V_{IH}	Input high voltage, differential inputs IN and IN#		–	$V_{DD} + 0.3$	V
V_{IL}	Input low voltage, differential inputs IN and IN#		–0.3	–	V
$V_{ID_LVDS}^{[3]}$	LVDS input differential amplitude	See Figure 2 on page 8	0.4	0.8	V
$V_{ID_LVPECL}^{[3]}$	LVPECL/CML/HCSL input differential amplitude	See Figure 2 on page 8	0.4	1.0	V
V_{ICM}	Input common mode voltage	See Figure 2 on page 8	0.2	$V_{DD} - 0.2$	V
I_{IH}	Input high current, differential inputs IN and IN#	Input = $V_{DD}^{[4]}$	–	150	μA
I_{IL}	Input low current, differential inputs IN and IN#	Input = $V_{SS}^{[4]}$	–150	–	μA
V_{OH}	LVPECL output high voltage	Terminated with $50\ \Omega$ to $V_{DD} - 2.0$ ^[5]	$V_{DD} - 1.20$	$V_{DD} - 0.70$	V
V_{OL}	LVPECL output low voltage	Terminated with $50\ \Omega$ to $V_{DD} - 2.0$ ^[5]	$V_{DD} - 2.0$	$V_{DD} - 1.63$	V
C_{IN}	Input capacitance	Measured at 10 MHz; per pin	–	3	pF

Thermal Resistance

Parameter ^[6]	Description	Test Conditions	8-pin SOIC	8-pin TSSOP	Unit
θ_{JA}	Thermal resistance (junction to ambient)	Test conditions follow standard test methods and procedures for measuring thermal impedance, in accordance with EIA/JESD51.	133	162	$^\circ\text{C/W}$
θ_{JC}	Thermal resistance (junction to case)		44	29	$^\circ\text{C/W}$

Notes

- V_{ID} minimum of 400 mV is required to meet all output AC Electrical Specifications. The device is functional with V_{ID} minimum of greater than 200 mV.
- Positive current flows into the input pin, negative current flows out of the input pin.
- Refer to Figure 3 on page 8.
- These parameters are guaranteed by design and are not tested.

AC Electrical Specifications

($V_{DD} = 3.3\text{ V} \pm 5\%$ or $2.5\text{ V} \pm 5\%$; $T_A = 0\text{ }^\circ\text{C}$ to $70\text{ }^\circ\text{C}$ (Commercial) or $-40\text{ }^\circ\text{C}$ to $85\text{ }^\circ\text{C}$ (Industrial))

Parameter	Description	Condition	Min	Typ	Max	Unit
F_{IN}	Input frequency	Differential Input	DC	–	1.5	GHz
		Single-ended CMOS Input ^[7]	DC	–	250	MHz
F_{OUT}	Output frequency	$F_{OUT} = F_{IN}$, Differential Input	DC	–	1.5	GHz
		$F_{OUT} = F_{IN}$, Single-ended CMOS Input ^[7]	DC	–	250	MHz
V_{PP}	LVPECL differential output voltage peak to peak, single-ended, terminated with $50\ \Omega$ to $V_{DD} - 2.0$ ^[8]	$F_{out} = \text{DC to } 150\text{ MHz}$	600	–	–	mV
		$F_{out} = >150\text{ MHz to } 1.5\text{ GHz}$	400	–	–	mV
t_{PD} ^[9]	Propagation delay differential input pair to differential output pair	Input rise/fall time $< 1.5\text{ ns}$ (20% to 80%)	–	–	480	ps
t_{ODC} ^[10]	Output duty cycle	50% duty cycle at input, Frequency range up to 1 GHz, Differential input	48	–	52	%
		50% duty cycle at input, Frequency range up to 250MHz, Single-ended CMOS input ^[7]	45	–	55	%
t_{SK1} ^[11]	Output-to-output skew	Any output to any output, with same load conditions at DUT	–	–	20	ps
t_{SK1D} ^[11]	Device-to-device output skew	Any output to any output between two or more devices. Devices must have the same input and have the same output load.	–	–	150	ps
PN_{ADD}	Additive RMS phase noise, 156.25-MHz input, Rise/fall time $< 150\text{ ps}$ (20% to 80%), $V_{ID} > 400\text{ mV}$ or Input Swing = 3.0 V ^[7]	Offset = 1 kHz	–	–	–120	dBc/Hz
		Offset = 10 kHz	–	–	–130	dBc/Hz
		Offset = 100 kHz	–	–	–135	dBc/Hz
		Offset = 1 MHz	–	–	–145	dBc/Hz
		Offset = 10 MHz	–	–	–153	dBc/Hz
		Offset = 20 MHz	–	–	–155	dBc/Hz

Notes

7. Refer to Application Information on page 10.
8. Refer to Figure 3 on page 8.
9. Refer to Figure 4 on page 8.
10. Refer to Figure 5 on page 8.
11. Refer to Figure 6 on page 9.

AC Electrical Specifications (continued)

 ($V_{DD} = 3.3\text{ V} \pm 5\%$ or $2.5\text{ V} \pm 5\%$; $T_A = 0\text{ }^\circ\text{C}$ to $70\text{ }^\circ\text{C}$ (Commercial) or $-40\text{ }^\circ\text{C}$ to $85\text{ }^\circ\text{C}$ (Industrial))

Parameter	Description	Condition	Min	Typ	Max	Unit
$t_{JIT}^{[12]}$	Additive RMS phase jitter (Random)	156.25 MHz, 12 kHz to 20 MHz offset; input rise/fall time < 150 ps (20% to 80%), $V_{ID} > 400\text{ mV}$	–	–	0.15	ps
		156.25 MHz Sinewave, 12 kHz to 20 MHz offset, input rise/fall time < 150 ps (20% to 80%), Input Swing = 3.0 V ^[13]	–	–	0.15	ps
$t_R, t_F^{[14]}$	Output rise/fall time	50% duty cycle at input, 20% to 80% of full swing (V_{OL} to V_{OH}) Input rise/fall time < 1.5 ns (20% to 80%)	–	–	250	ps

Notes

12. Refer to Figure 7 on page 9.
 13. Refer to Application Information on page 10.
 14. Refer to Figure 8 on page 9.

Switching Waveforms

Figure 2. Input Differential and Common Mode Voltages

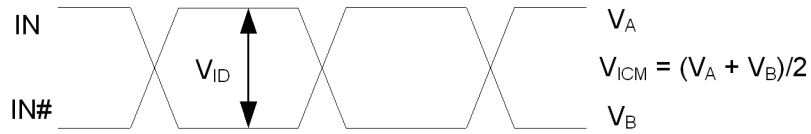

Figure 3. Output Differential Voltage

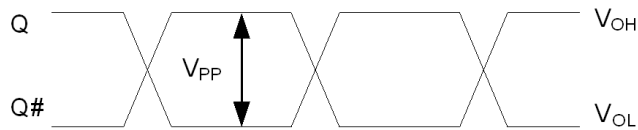

Figure 4. Input to Any Output Pair Propagation Delay

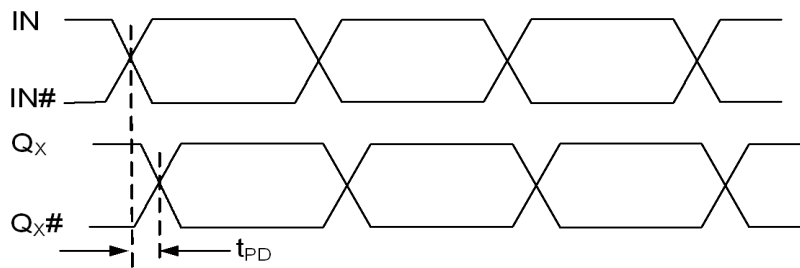
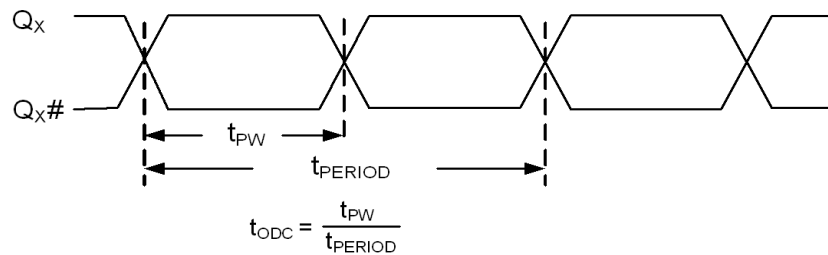

Figure 5. Output Duty Cycle



Switching Waveforms (continued)

Figure 6. Output-to-Output and Device-to-Device Skew

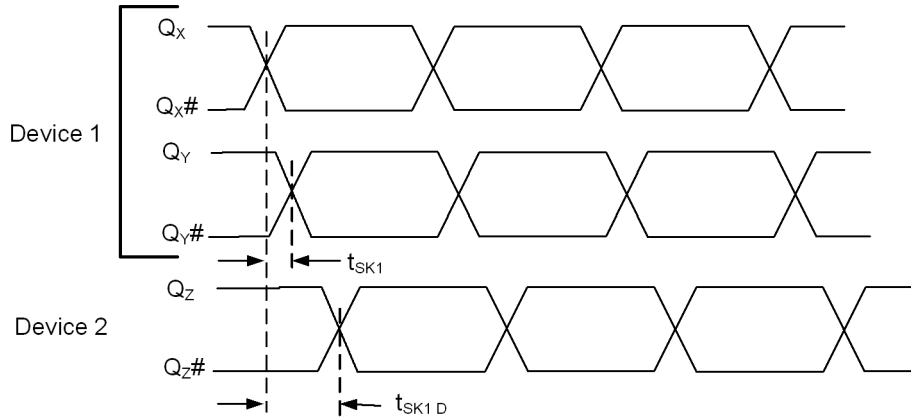

Figure 7. RMS Phase Jitter

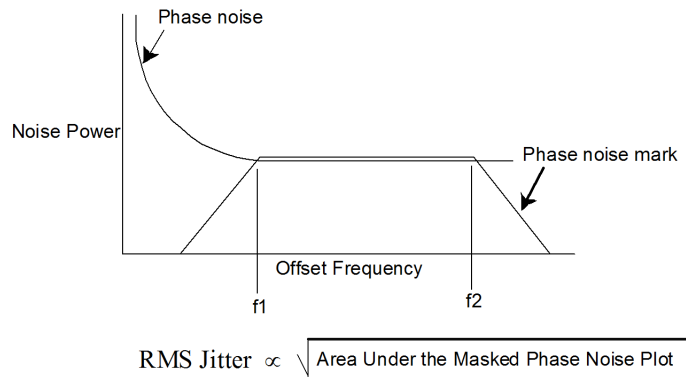
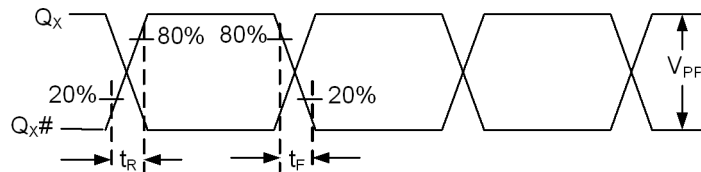

Figure 8. Output Rise/Fall Time



Application Information

CY2DP1502 can be used with a single ended CMOS input by biasing the Complementary Input Clock (INx#). “True” input pins (INx) of differential input pair can be fed with a single ended CMOS input signal. The “complementary” input pin (INx#) of the same differential input pair can be biased with Vref.

Figure 9 shows the schematic which can be used to give single ended CMOS input to the CY2DP1502.

The reference voltage $V_{ref} = VDD/2$ is generated by the bias resistors R1, R2 and capacitor C0. This bias circuit should be located as close as possible to the input pin. The ratio of R1 and R2 might need to be adjusted to position the Vref in the center of the input voltage swing. For example, if the input clock swing is 2.5 V and $VDD = 3.3$ V, V_{ref} should be 1.25 V and $R2/R1 = 0.609$.

Figure 9. Application Example

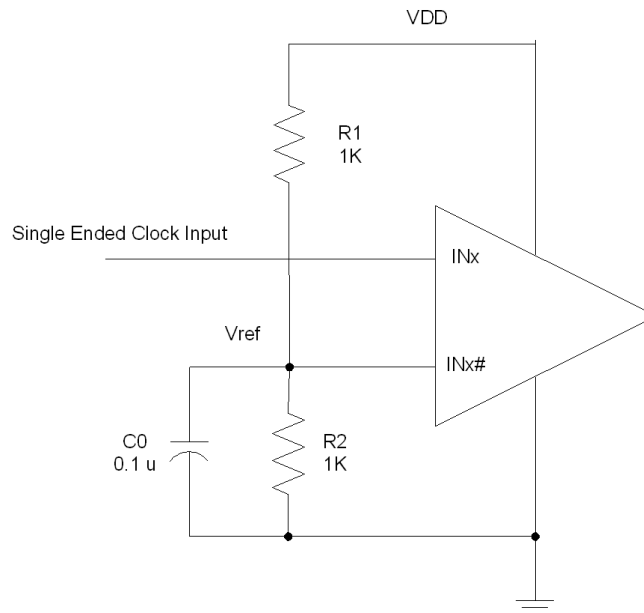

Ordering Information

Part Number	Type	Production Flow
Pb-free		
CY2DP1502SXI	8-pin SOIC	Industrial, -40 °C to 85 °C
CY2DP1502SXIT	8-pin SOIC – Tape and Reel	Industrial, -40 °C to 85 °C
CY2DP1502ZXI	8-pin TSSOP	Industrial, -40 °C to 85 °C
CY2DP1502ZXIT	8-pin TSSOP – Tape and Reel	Industrial, -40 °C to 85 °C

Ordering Code Definitions

CY 2DP15 02 X X X X

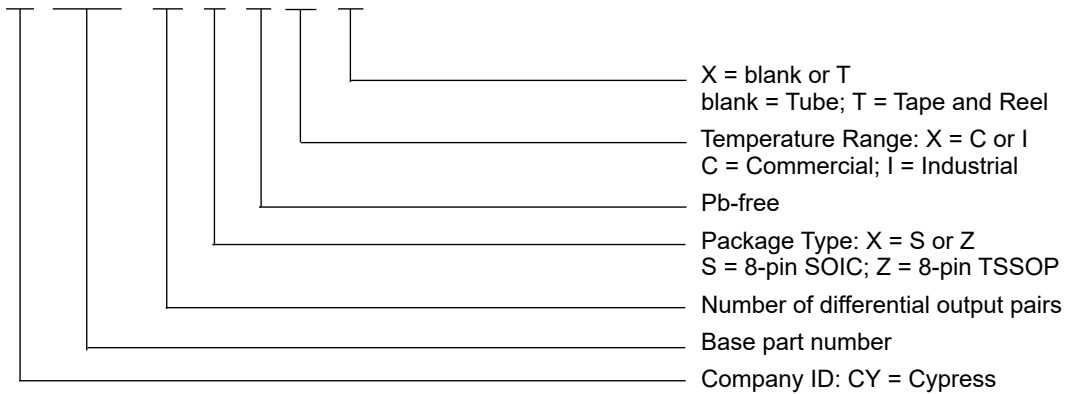

Package Diagrams

Figure 10. 8-pin SOIC (150 Mils) S08.15/SZ08.15 Package Outline, 51-85066

1. DIMENSIONS IN INCHES[MM] MIN. MAX.
2. PIN 1 ID IS OPTIONAL, ROUND ON SINGLE LEADFRAME RECTANGULAR ON MATRIX LEADFRAME
3. REFERENCE JEDEC MS-012
4. PACKAGE WEIGHT 0.07gms

PART #	
S08.15	STANDARD PKG
SZ08.15	LEAD FREE PKG
SW8.15	LEAD FREE PKG

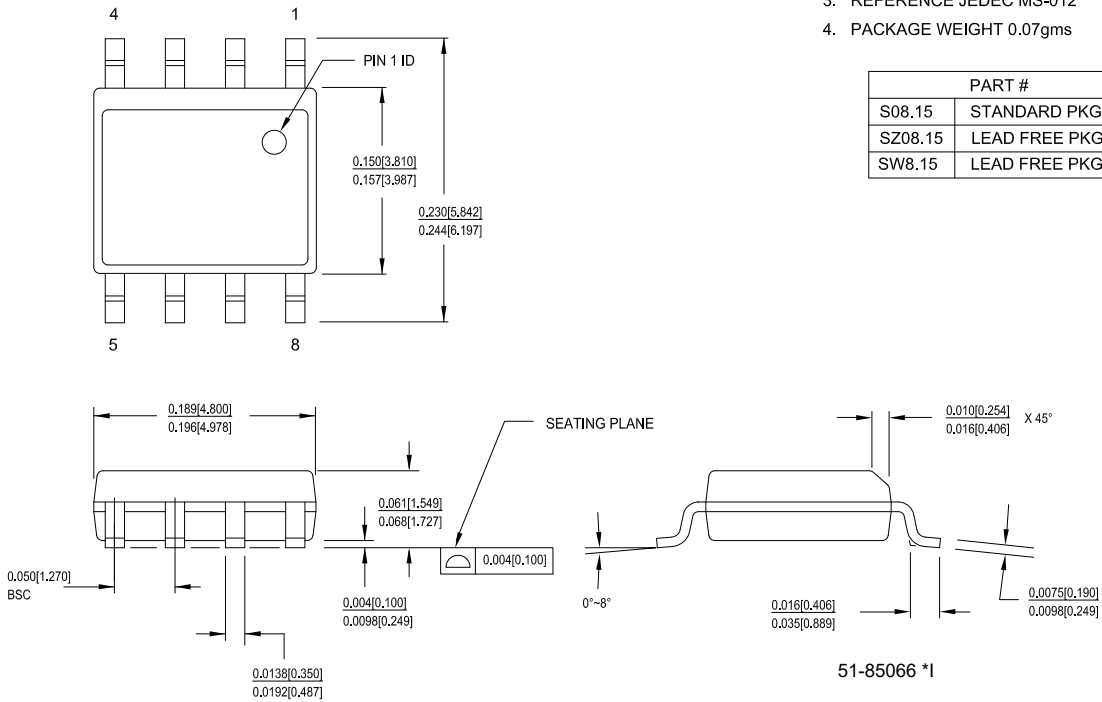

Package Diagrams (continued)

Figure 11. 8-pin TSSOP 4.40 mm Body Z08.173/ZZ08.173 Package Outline, 51-85093

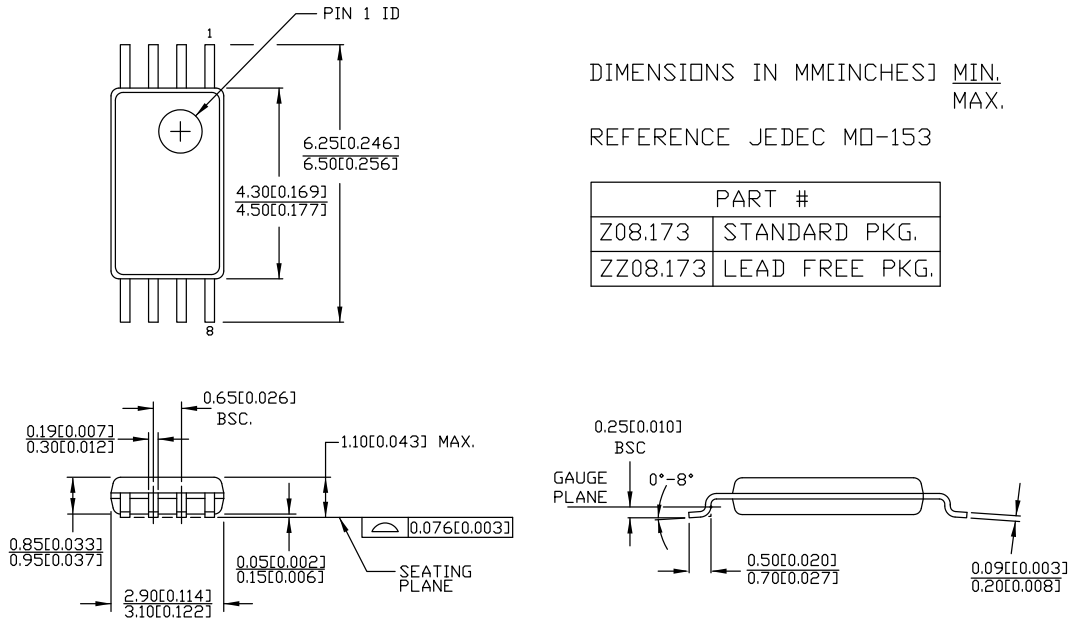

DIMENSIONS IN MM[INCHES] MIN. MAX.

REFERENCE JEDEC MO-153

PART #	
Z08.173	STANDARD PKG.
ZZ08.173	LEAD FREE PKG.

51-85093 *E

Acronyms

Acronym	Description
ESD	electrostatic discharge
HBM	Human Body Model
HCSL	high-speed current steering logic
JEDEC	Joint Electron Devices Engineering Council
LVDS	low-voltage differential signal
LVC MOS	low-voltage complementary metal oxide semiconductor
LVPECL	low-voltage positive emitter-coupled logic
LVTTTL	low-voltage transistor-transistor logic
RMS	root mean square
TSSOP	thin shrunk small outline package

Document Conventions

Units of Measure

Symbol	Units of Measure
°C	degree Celsius
dBc	decibels relative to the carrier
GHz	gigahertz
Hz	hertz
kΩ	kilohm
MHz	megahertz
μA	microampere
μF	microfarad
μs	microsecond
mA	milliampere
ms	millisecond
mV	millivolt
ns	nanosecond
Ω	ohm
pF	picofarad
ps	picosecond
V	volt
W	watt

Document History Page

Document Title: CY2DP1502, 1:2 LVPECL Fanout Buffer Document Number: 001-56308				
Revision	ECN	Orig. of Change	Submission Date	Description of Change
**	2782891	CXQ	10/09/2009	New data sheet.
*A	2838916	CXQ	01/05/2010	<p>Changed status from Advance to Preliminary.</p> <p>Updated Features: Replaced “0.34 ps Maximum Additive RMS Phase Jitter” with “0.25 ps Maximum Additive RMS Phase Jitter”.</p> <p>Updated Operating Conditions: Added t_{PU} parameter and its details.</p> <p>Updated DC Electrical Specifications: Changed minimum value of V_{OH} parameter from “$V_{DD} - 1.15 V$” to “$V_{DD} - 1.20 V$”. Changed maximum value of V_{OH} parameter from “$V_{DD} - 0.75 V$” to “$V_{DD} - 0.70 V$”. Removed V_{OD} parameter and its details. Added R_P parameter and its details. Added details in “Test Condition” column corresponding to C_{IN} parameter.</p> <p>Updated AC Electrical Specifications: Updated details in “Parameter” column (Changed letter case and some names of parameters to be consistent with EROS). Added V_{PP} parameter and its details. Changed maximum value of t_{JIT} parameter from 0.34 ps to 0.25 ps. Updated maximum values of PN_{ADD} parameter (Lowered all values by 3 dB). Updated details in “Condition” column of t_R, t_F parameter (Added “Input rise/fall time < 1.5 ns (20% to 80%)”).</p> <p>Updated Switching Waveforms: No change in figures (Changed letter case and some names of timing parameters in all figures to be consistent with EROS).</p>
*B	3011766	CXQ	08/20/2010	<p>Updated Features: Replaced “0.25 ps Maximum Additive RMS Phase Jitter” with “0.11 ps Maximum Additive RMS Phase Jitter”.</p> <p>Updated Functional Description: Updated description.</p> <p>Updated Logic Block Diagram: Changed R_P for differential inputs from 100 kΩ to 150 kΩ.</p> <p>Updated DC Electrical Specifications: Added 1.0 V in “Max” column corresponding to V_{ID} parameter. Added Note 4 and referred the same note in “Test Condition” column of I_{IH} and I_{IL} parameters. Changed minimum value of R_P parameter from 60 kΩ to 90 kΩ. Changed maximum value of R_P parameter from 140 kΩ to 210 kΩ.</p> <p>Updated AC Electrical Specifications: Added “Frequency range up to 1 GHz” in “Test Condition” column corresponding to t_{ODC} parameter. Updated maximum values of PN_{ADD} parameter. Changed maximum value of t_{JIT} parameter from 0.25 ps to 0.11 ps.</p> <p>Updated Ordering Information: No change in part numbers. Added Ordering Code Definitions. Updated Package Diagrams: spec 51-85066 – Changed revision from *C to *D. spec 51-85093 – Changed revision from *B to *C. Added Acronyms and Units of Measure.</p>
*C	3017258	CXQ	08/27/2010	<p>Updated AC Electrical Specifications: Updated Figure 8.</p>

Document History Page (continued)

Document Title: CY2DP1502, 1:2 LVPECL Fanout Buffer Document Number: 001-56308				
Revision	ECN	Orig. of Change	Submission Date	Description of Change
*D	3100234	CXQ	11/18/2010	<p>Updated Absolute Maximum Ratings: Changed maximum value of V_{IN} parameter from 4.0 V to "lesser of 4.0 or $V_{DD} + 0.4$". Changed maximum value of V_{OUT} parameter from 4.0 V to "lesser of 4.0 or $V_{DD} + 0.4$". Removed minimum value of LU parameter. Added "Meets or exceeds JEDEC Spec JESD78B IC Latch-up Test" under "Min" and "Max" columns of LU parameter.</p> <p>Updated DC Electrical Specifications: Removed R_p parameter and its details. Replaced "Measured at 1 MHz" with "Measured at 10 MHz" in "Condition" column corresponding to C_{IN} parameter.</p> <p>Updated AC Electrical Specifications: Updated maximum values of PN_{ADD} parameter corresponding to Conditions "Offset = 1 MHz", "Offset = 10 MHz", and "Offset = 20 MHz". Changed maximum value of t_{JIT} parameter from 0.11 ps to 0.15 ps.</p>
*E	3137726	CXQ	01/13/2011	<p>Changed status from Preliminary to Final. Updated Logic Block Diagram (Removed resistors on IN/IN#).</p>
*F	3137726	CXQ	01/13/2011	<p>Minor change: Post to external web.</p>
*G	3234654	VED	04/19/2011	<p>Minor change: Revision was not updated in footer in previous revision and updated in this version. Description of Changed was not updated in previous revision and updated in this revision.</p>
*H	3308039	CXQ	07/11/2011	<p>Updated Features: Replaced "One low-voltage positive emitter-coupled logic (LVPECL) input pair distributed to two LVPECL output pairs" with "One differential (LVPECL, LVDS, or CML) input pair distributed to two LVPECL output pairs".</p> <p>Updated Pin Definitions: Updated details in "Description" column corresponding to pin 6 and 7.</p> <p>Updated DC Electrical Specifications: Replaced "LVPECL inputs" with "differential inputs" in "Description" column corresponding to V_{IH}, V_{IL}, I_{IH} and I_{IL} parameters. Removed V_{ID} parameter and its details. Added V_{ID_LVDS} and V_{ID_LVPECL} parameters and their details.</p> <p>Updated Package Diagrams: spec 51-85066 – Changed revision from *D to *E.</p>
*I	3395868	PURU	10/05/2011	<p>Updated Features: Replaced "One differential (LVPECL, LVDS, or CML) input pair distributed to two LVPECL output pairs" with "One differential (LVPECL, LVDS, HCSL, or CML) input pair distributed to two LVPECL output pairs".</p> <p>Updated Pin Definitions: Updated details in "Description" column corresponding to pin 6 and 7.</p> <p>Updated DC Electrical Specifications: Replaced "LVPECL/CML input differential amplitude" with "LVPECL/CML/HCSL input differential amplitude" in "Description" column corresponding to V_{ID_LVPECL} parameter. Changed minimum value of V_{ICM} parameter from 0.5 V to 0.2 V.</p>

Document History Page (continued)

Document Title: CY2DP1502, 1:2 LVPECL Fanout Buffer Document Number: 001-56308				
Revision	ECN	Orig. of Change	Submission Date	Description of Change
*J	3799048	PURU	12/05/2012	<p>Updated Features: Added "Translates any single-ended input signal to 3.3 V LVPECL levels with resistor bias on INx# input".</p> <p>Updated AC Electrical Specifications: Added Condition "Single Ended CMOS Input" and added corresponding values (Minimum value = DC, Maximum value = 250 MHz) for F_{IN} parameter. Added Condition "Single Ended CMOS Input" and added corresponding values (Minimum value = DC, Maximum value = 250 MHz) for F_{OUT} parameter. Added Note 7 and referred the same note in "Single-ended CMOS Input" in "Condition" column of F_{IN} and F_{OUT} parameters. Replaced "Propagation delay input pair to output pair" with "Propagation delay differential input pair to differential output pair" in "Description" column of t_{PD} parameter. Added Condition "Single Ended CMOS Input" and added corresponding values (Minimum value = 45%, Maximum value = 55%) for t_{ODC} parameter. Replaced "Additive RMS phase noise, 156.25-MHz input, Rise/fall time < 150 ps (20% to 80%), V_{ID} > 400 mV" with "Additive RMS phase noise, 156.25-MHz input, Rise/fall time < 150 ps (20% to 80%), V_{ID} > 400 mV or Input Swing = 3.0 V^[7]" in "Description" column of PN_{ADD} parameter. Added Condition "156.25 MHz Sinewave, 12 kHz to 20 MHz offset, input rise/fall time < 150 ps (20% to 80%), Input Swing = 3.0 V^[13]" and added corresponding values (Maximum value = 0.15 ps) for t_{JIT} parameter. Added Note 13 and referred the same note in "Input Swing = 3.0 V" in "Condition" column of t_{JIT} parameter. Added Application Information. Updated Package Diagrams: spec 51-85093 – Changed revision from *C to *D. Updated to new template.</p>
*K	3882598	PURU	01/24/2013	<p>No technical updates. Completing Sunset Review.</p>
*L	4587249	PURU	12/04/2014	<p>Updated Functional Description: Added "For a complete list of related documentation, click here." at the end. Updated Ordering Information: Updated part numbers. Updated Package Diagrams: spec 51-85066 – Changed revision from *E to *F. spec 51-85093 – Changed revision from *D to *E. Completing Sunset Review.</p>
*M	5272915	PSR	05/16/2016	<p>Added Thermal Resistance. Updated Package Diagrams: spec 51-85066 – Changed revision from *F to *H. Updated to new template.</p>
*N	6079539	PAWK	02/23/2018	<p>Updated Package Diagrams: spec 51-85066 – Changed revision from *H to *I. Updated to new template. Completing Sunset Review.</p>

Sales, Solutions, and Legal Information

Worldwide Sales and Design Support

Cypress maintains a worldwide network of offices, solution centers, manufacturer's representatives, and distributors. To find the office closest to you, visit us at [Cypress Locations](#).

Products

Arm® Cortex® Microcontrollers	cypress.com/arm
Automotive	cypress.com/automotive
Clocks & Buffers	cypress.com/clocks
Interface	cypress.com/interface
Internet of Things	cypress.com/iot
Memory	cypress.com/memory
Microcontrollers	cypress.com/mcu
PSoC	cypress.com/psoc
Power Management ICs	cypress.com/pmic
Touch Sensing	cypress.com/touch
USB Controllers	cypress.com/usb
Wireless Connectivity	cypress.com/wireless

PSoC® Solutions

[PSoC 1](#) | [PSoC 3](#) | [PSoC 4](#) | [PSoC 5LP](#) | [PSoC 6 MCU](#)

Cypress Developer Community

[Community](#) | [Projects](#) | [Video](#) | [Blogs](#) | [Training](#) | [Components](#)

Technical Support

cypress.com/support

© Cypress Semiconductor Corporation, 2009-2018. This document is the property of Cypress Semiconductor Corporation and its subsidiaries, including Spansion LLC ("Cypress"). This document, including any software or firmware included or referenced in this document ("Software"), is owned by Cypress under the intellectual property laws and treaties of the United States and other countries worldwide. Cypress reserves all rights under such laws and treaties and does not, except as specifically stated in this paragraph, grant any license under its patents, copyrights, trademarks, or other intellectual property rights. If the Software is not accompanied by a license agreement and you do not otherwise have a written agreement with Cypress governing the use of the Software, then Cypress hereby grants you a personal, non-exclusive, nontransferable license (without the right to sublicense) (1) under its copyright rights in the Software (a) for Software provided in source code form, to modify and reproduce the Software solely for use with Cypress hardware products, only internally within your organization, and (b) to distribute the Software in binary code form externally to end users (either directly or indirectly through resellers and distributors), solely for use on Cypress hardware product units, and (2) under those claims of Cypress's patents that are infringed by the Software (as provided by Cypress, unmodified) to make, use, distribute, and import the Software solely for use with Cypress hardware products. Any other use, reproduction, modification, translation, or compilation of the Software is prohibited.

TO THE EXTENT PERMITTED BY APPLICABLE LAW, CYPRESS MAKES NO WARRANTY OF ANY KIND, EXPRESS OR IMPLIED, WITH REGARD TO THIS DOCUMENT OR ANY SOFTWARE OR ACCOMPANYING HARDWARE, INCLUDING, BUT NOT LIMITED TO, THE IMPLIED WARRANTIES OF MERCHANTABILITY AND FITNESS FOR A PARTICULAR PURPOSE. To the extent permitted by applicable law, Cypress reserves the right to make changes to this document without further notice. Cypress does not assume any liability arising out of the application or use of any product or circuit described in this document. Any information provided in this document, including any sample design information or programming code, is provided only for reference purposes. It is the responsibility of the user of this document to properly design, program, and test the functionality and safety of any application made of this information and any resulting product. Cypress products are not designed, intended, or authorized for use as critical components in systems designed or intended for the operation of weapons, weapons systems, nuclear installations, life-support devices or systems, other medical devices or systems (including resuscitation equipment and surgical implants), pollution control or hazardous substances management, or other uses where the failure of the device or system could cause personal injury, death, or property damage ("Unintended Uses"). A critical component is any component of a device or system whose failure to perform can be reasonably expected to cause the failure of the device or system, or to affect its safety or effectiveness. Cypress is not liable, in whole or in part, and you shall and hereby do release Cypress from any claim, damage, or other liability arising from or related to all Unintended Uses of Cypress products. You shall indemnify and hold Cypress harmless from and against all claims, costs, damages, and other liabilities, including claims for personal injury or death, arising from or related to any Unintended Uses of Cypress products.

Cypress, the Cypress logo, Spansion, the Spansion logo, and combinations thereof, WICED, PSoC, CapSense, EZ-USB, F-RAM, and Traveo are trademarks or registered trademarks of Cypress in the United States and other countries. For a more complete list of Cypress trademarks, visit cypress.com. Other names and brands may be claimed as property of their respective owners.

Mouser Electronics

Authorized Distributor

Click to View Pricing, Inventory, Delivery & Lifecycle Information:

Cypress Semiconductor:

[CY2DP1502SXC](#) [CY2DP1502SXCT](#) [CY2DP1502SXI](#) [CY2DP1502SXIT](#) [CY2DP1502ZXC](#) [CY2DP1502ZXCT](#)
[CY2DP1502ZXI](#) [CY2DP1502ZXIT](#)