

# PXD30-xxWS-xx-Single Output DC/DC Converters

9 to 36 Vdc and 18 to 75 Vdc input, 1.5 to 15 Vdc Single Output, 30W

## TDK-Lambda

### Applications

- Wireless Network
- Telecom / Datacom
- Industry Control System
- Measurement
- Semiconductor Equipment

### Features

- RoHS compliant
- Single output up to 8.5A
- Six-sided continuous shield
- No minimum load required
- High power density
- High efficiency up to 91%
- Small size  
2.00 x 1.00 x 0.400 inch (50.8×25.4×10.2 mm )
- Input to output isolation (1600VDC)
- 4:1 ultra wide input voltage range
- Fixed switching frequency
- Input under-voltage protection
- Output over-voltage protection
- Over-current protection
- Output short circuit protection
- Remote on/off
- Case grounding

### Options

- Negative logic Remote On/Off
- Heatsink

## General Description

The PXD30-xxWS-xx single output series offers 30 watts of output power from a 2 x 1.0 x 0.4 inch package. This series has a 4:1 ultra wide input voltage of 9-36VDC, 18-75VDC and features 1600VDC of isolation, short circuit protection, over-voltage protection, over-current protection and six sided shielding. All models are particularly suited for telecommunications, industrial, mobile telecom and test equipment applications.

## Table of contents

Absolute Maximum Rating	P2	Output Voltage adjustment	P36
Output Specification	P2	Thermal Consideration	P37
Input Specification	P3	Heatsink Consideration	P38
General Specification	P4	Remote ON/OFF Control	P39
Characteristic Curves	P5	Mechanical Data	P40
Testing Configurations	P33	Recommended Pad Layout	P40
EMC Considerations	P34	Soldering and Reflow Consideration	P41
Input Source Impedance	P35	Packaging Information	P42
Output Over Current Protection	P35	Part Number Structure	P43
Output Over Voltage Protection	P35	Safety and Installation Instruction	P43
Short Circuit Protection	P35	MTBF and Reliability	P44

Absolute Maximum Ratings				
Parameter	Model	Min	Max	Unit
Input Voltage	Continuous	24WSxx	40	Vdc
		48WSxx	80	
Transient (100ms)		24WSxx	50	
		48WSxx	100	
Operating Ambient Temperature without derating	All	-40	50	°C
		50	85	
Operating Case Temperature	All		105	°C
Storage Temperature	All	-55	105	°C

Output Specification					
Parameter	Model	Min	Typ	Max	Unit
Output Voltage ( $V_{in} = V_{in(nom)}$ ; Full Load ; $T_A=25^{\circ}C$ )	xxWS1P5	1.485	1.5	1.515	Vdc
	xxWS2P5	2.475	2.5	2.525	
	xxWS3P3	3.267	3.3	3.333	
	xxWS05	4.95	5.0	5.05	
	xxWS5P1	5.049	5.1	5.151	
	xxWS12	11.88	12	12.12	
	xxWS15	14.85	15	15.15	
Voltage adjustability	All	-10		+10	%
Output Regulation Line ( $V_{in}(\min)$ to $V_{in}(\max)$ at Full Load)	All	-0.2		+0.2	% $V_o$
		-0.5		+0.5	
Output Ripple & Noise Peak-to-Peak (5Hz to 20MHz bandwidth) (Measured with a 1 $\mu$ F/50V MLCC)	xxWS1P5			100	mVp-p
	xxWS2P5			100	
	xxWS3P3			100	
	xxWS05			100	
	xxWS5P1			100	
	xxWS12			150	
	xxWS15			150	
Temperature Coefficient	All	-0.02		+0.02	% $V_o/^{\circ}C$
Output Voltage Overshoot ( $V_{in} = V_{in}(\min)$ to $V_{in}(\max)$ ; Full Load ; $T_A=25^{\circ}C$ )	All		0	5	% $V_o$
Dynamic Load Response ( $V_{in} = V_{in}(\text{nom})$ ; $T_A=25^{\circ}C$ ) Load step change from 75% to 100% or 100 to 75% of Full Load Peak Deviation	All		300		mV
	All		250		$\mu$ s
Output Current	xxWS1P5	0		8500	mA
	xxWS2P5	0		8000	
	xxWS3P3	0		7500	
	xxWS05	0		6000	
	xxWS5P1	0		6000	
	xxWS12	0		2500	
	xxWS15	0		2000	

Output Specification(Continued)					
Parameter	Model	Min	Typ	Max	Unit
Output Over Voltage Protection (Zener diode clamp)	xxWS1P5		2.0		Vdc
	xxWS2P5		3.3		
	xxWS3P3		3.9		
	xxWS05		6.2		
	xxWS5P1		6.2		
	xxWS12		15		
	xxWS15		18		
Output Over Current Protection	All		150		% FL.
Output Short Circuit Protection	All	Hiccup, automatic recovery			

Input Specification					
Parameter	Model	Min	Typ	Max	Unit
Operating Input Voltage	24WSxx	9	24	36	Vdc
	48WSxx	18	48	75	
Input Current (Maximum value at $V_{in} = V_{in(nom)}$ ; Full Load)	24WS1P5			700	mA
	24WS2P5			1054	
	24WS3P3			1258	
	24WS05			1488	
	24WS5P1			1517	
	24WS12			1471	
	24WS15			1471	
	48WS1P5			350	
	48WS2P5			520	
	48WS3P3			629	
	48WS05			744	
	48WS5P1			759	
	48WS12			727	
	48WS15			718	
Input Standby current (Typical value at $V_{in} = V_{in(nom)}$ ; No Load)	24WS1P5		70		mA
	24WS2P5		70		
	24WS3P3		70		
	24WS05		105		
	24WS5P1		105		
	24WS12		20		
	24WS15		30		
	48WS1P5		30		
	48WS2P5		45		
	48WS3P3		45		
	48WS05		65		
	48WS5P1		65		
	48WS12		60		
	48WS15		50		
Under Voltage Lockout Turn-on Threshold	24WSxx		9		Vdc
	48WSxx		36		
Under Voltage Lockout Turn-off Threshold	24WSxx		8		Vdc
	48WSxx		32		

Input Specification(Continuous)					
Parameter	Model	Min	Typ	Max	Unit
Input reflected ripple current (5 to 20MHz, 12 $\mu$ H source impedance)	All		20		mAp-p
Start Up Time (Vin = Vin(nom) and constant resistive load)	All				ms
Power up			30		
Remote ON/OFF			30		
Remote ON/OFF Control (The On/Off pin voltage is referenced to -Vin)	All				
Positive logic					
On/Off pin High Voltage (Remote ON)		3.0		12	Vdc
On/Off pin Low Voltage (Remote OFF)		0		1.2	Vdc
Negative logic					
On/Off pin Low Voltage (Remote ON)		0		1.2	Vdc
On/Off pin High Voltage (Remote OFF)	3.0		12	Vdc	
Remote Off Input Current	All		3		mA
Input Current of Remote Control Pin	All	-0.5		0.5	mA

General Specification						
Parameter	Model	Min	Typ	Max	Unit	
Efficiency (Vin = Vin(nom) ; Full Load ; TA=25°C)	24WS1P5 24WS2P5 24WS3P3 24WS05 24WS5P1 24WS12 24WS15 48WS1P5 48WS2P5 48WS3P3 48WS05 48WS5P1 48WS12 48WS15		80 83 86 88 88 89 89 80 84 86 88 88 90 91			%
Case grounding	All	Connect case to -Vin with decoupling Y cap.				
Isolation voltage	All				Vdc	
Input to Output Input to Case, Output to Case		1600 1600				
Isolation resistance	All	1			G $\Omega$	
Isolation capacitance	All			1500	pF	
Switching Frequency	All		430		KHz	
Weight	All		30.5		g	
MTBF	All				hours	
Bellcore TR-NWT-000332, Tc=40°C MIL-HDBK-217F			3.17 $\times$ 10 <sup>6</sup> 4.35 $\times$ 10 <sup>5</sup>			
Over temperature protection	All		115		°C	

Characteristic Curves

All test conditions are at 25°C. The figures are for PXD30-24WS1P5

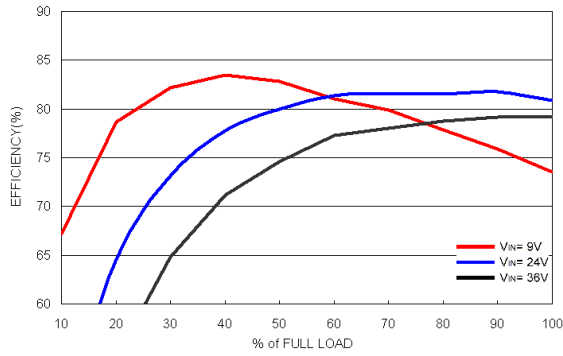

Efficiency Versus Output Current

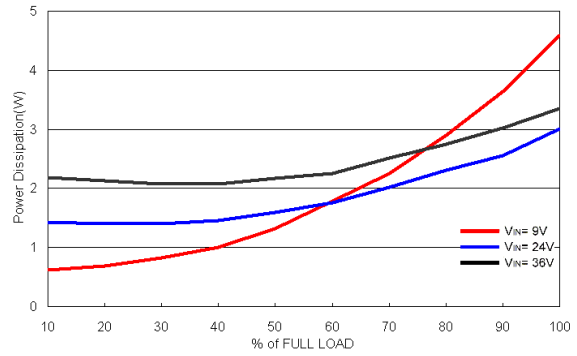

Power Dissipation Versus Output Current

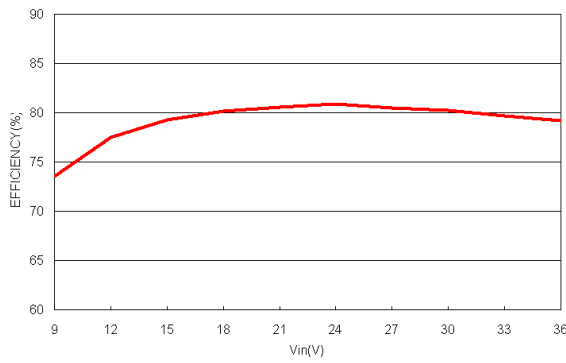

Efficiency Versus Input Voltage. Full Load

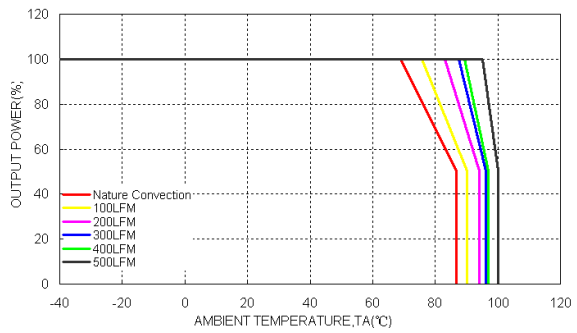

Derating Output Current Versus Ambient Temperature and Airflow  
 $V_{in}=V_{in}(nom)$

Characteristic Curves (Continued)

All test conditions are at 25°C. The figures are for PXD30-24WS1P5

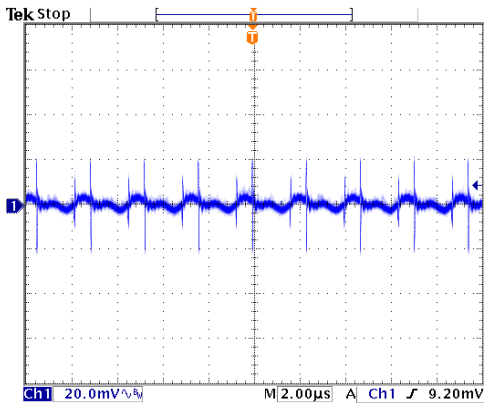

Typical Output Ripple and Noise.  
Vin=Vin(nom), Full Load

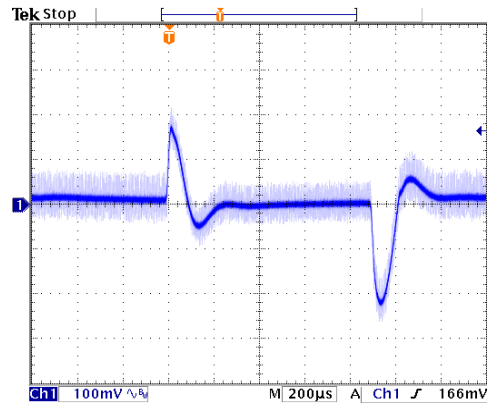

Transient Response to Dynamic Load Change from 100% to 75% to 100% of Full Load ; Vin=Vin(nom)

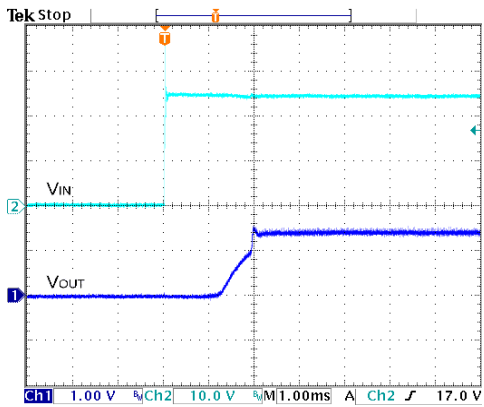

Typical Input Start-Up and Output Rise Characteristic  
Vin=Vin(nom), Full Load

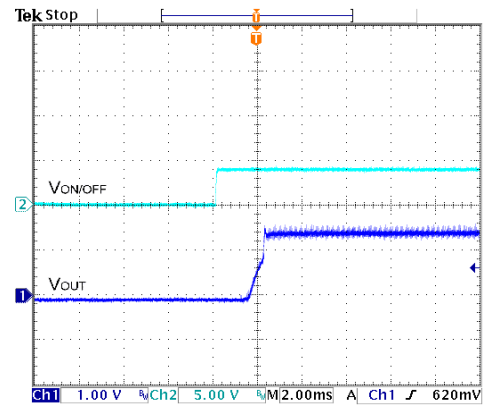

Using ON/OFF Voltage Start-Up and V<sub>O</sub> Rise Characteristic  
Vin=Vin(nom), Full Load

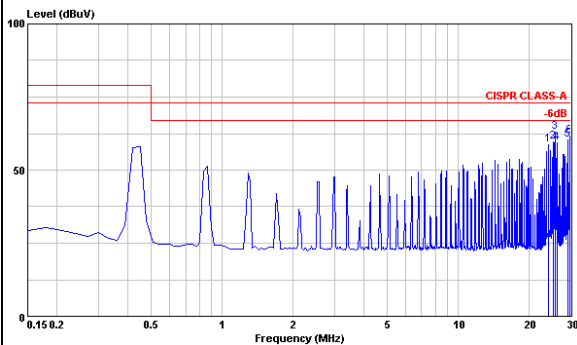

Conduction Emission of EN55022 Class A  
Vin=Vin(nom), Full Load

Characteristic Curves (Continued)

All test conditions are at 25°C. The figures are for PXD30-24WS2P5

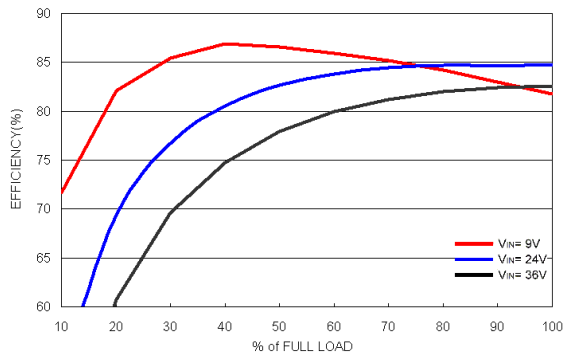

Efficiency Versus Output Current

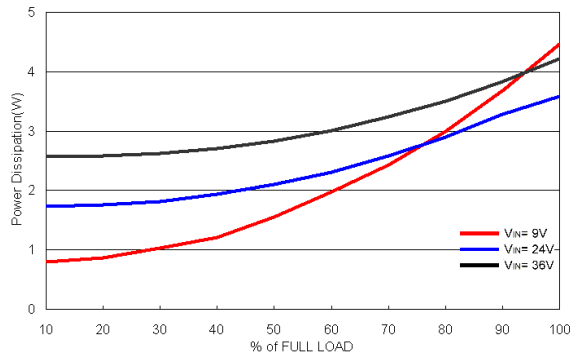

Power Dissipation Versus Output Current

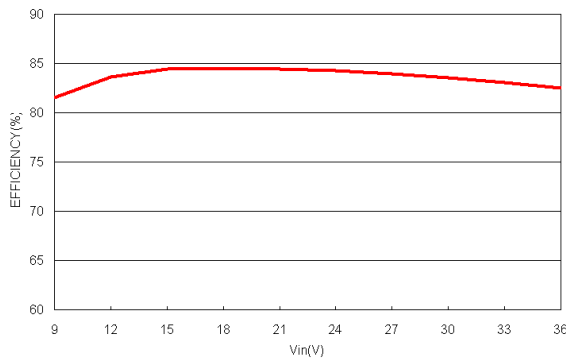

Efficiency Versus Input Voltage. Full Load

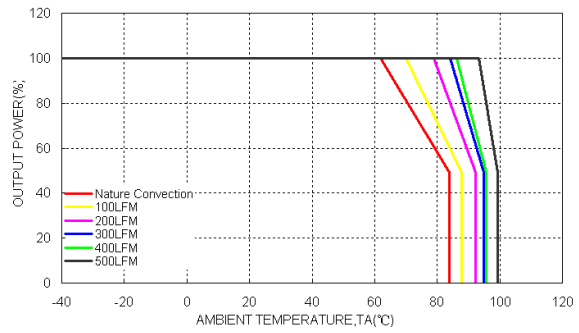

Derating Output Current Versus Ambient Temperature and Airflow  
 $V_{in}=V_{in}(nom)$

Characteristic Curves (Continued)

All test conditions are at 25°C The figures are for PXD30-24WS2P5

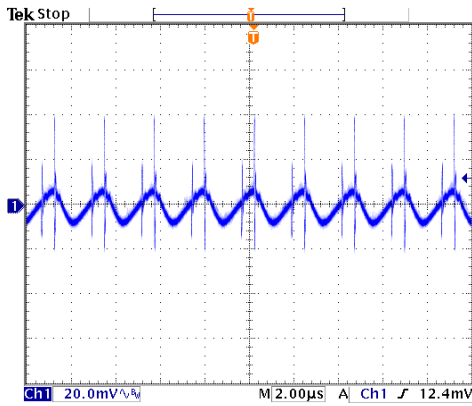

Typical Output Ripple and Noise.  
Vin=Vin(nom), Full Load

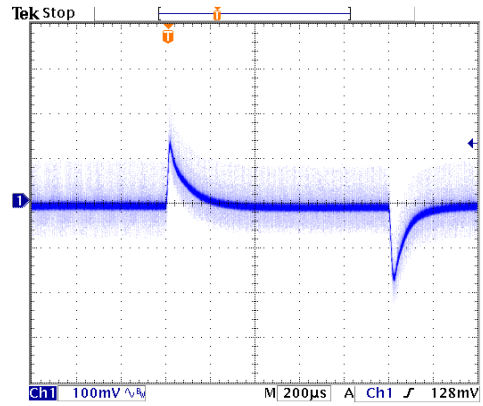

Transient Response to Dynamic Load Change from 100% to 75% to 100% of Full Load ; Vin=Vin(nom)

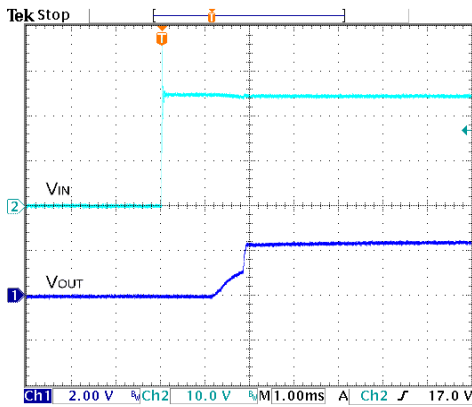

Typical Input Start-Up and Output Rise Characteristic  
Vin=Vin(nom), Full Load

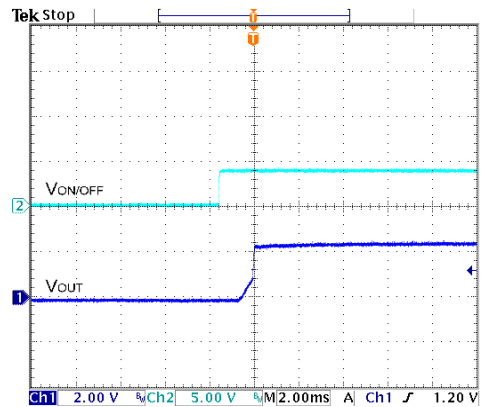

Using ON/OFF Voltage Start-Up and Vo Rise Characteristic  
Vin=Vin(nom), Full Load

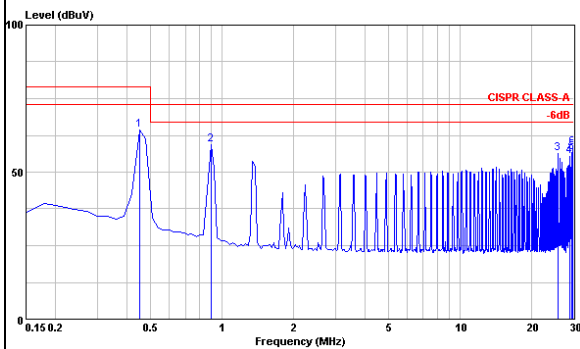

Conduction Emission of EN55022 Class A  
Vin=Vin(nom), Full Load



Characteristic Curves (Continued)

All test conditions are at 25°C. The figures are for PXD30-24WS3P3.

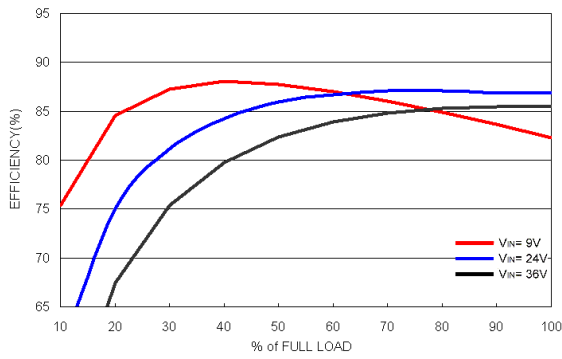

Efficiency Versus Output Current

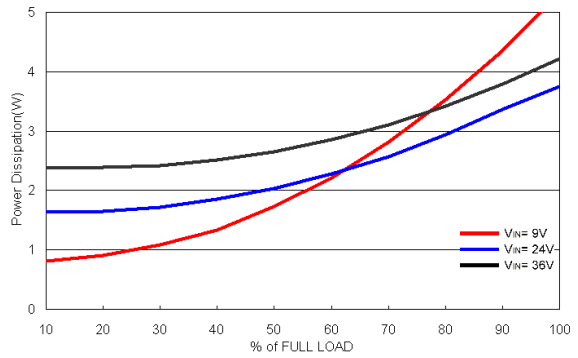

Power Dissipation Versus Output Current

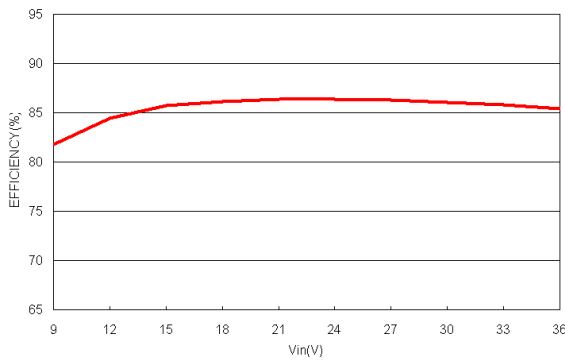

Efficiency Versus Input Voltage. Full Load

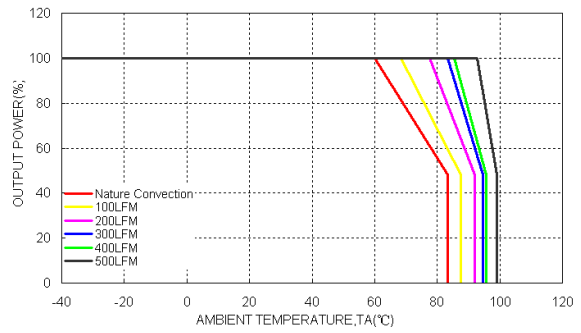

Derating Output Current Versus Ambient Temperature and Airflow  
 $V_{in}=V_{in}(nom)$

Characteristic Curves (Continued)

All test conditions are at 25°C. The figures are for PXD30-24WS3P3.

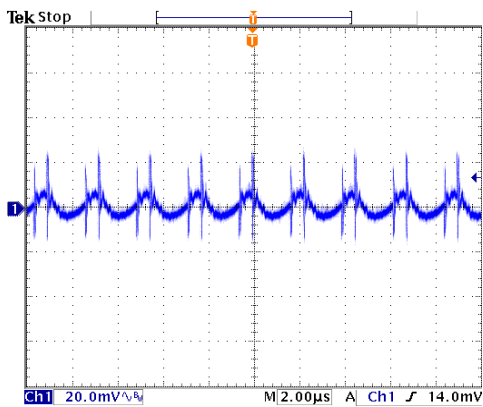

Typical Output Ripple and Noise.  
Vin=Vin(nom), Full Load

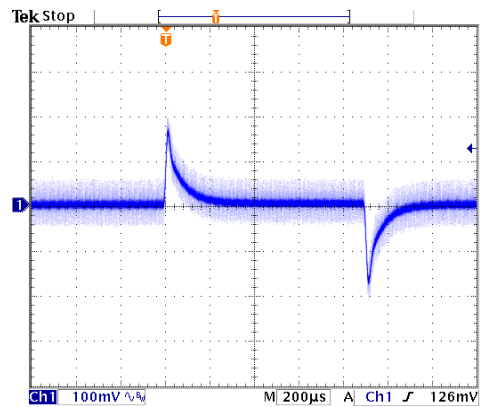

Transient Response to Dynamic Load Change from 100% to 75% to 100% of Full Load ; Vin=Vin(nom)

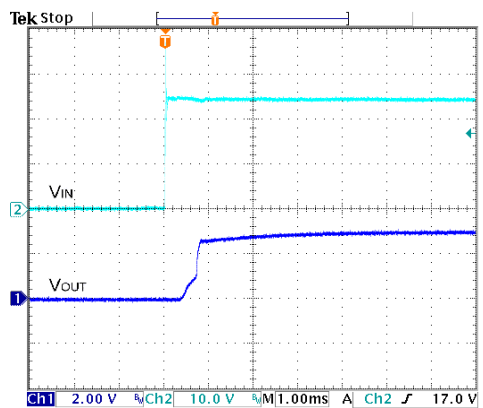

Typical Input Start-Up and Output Rise Characteristic  
Vin=Vin(nom), Full Load

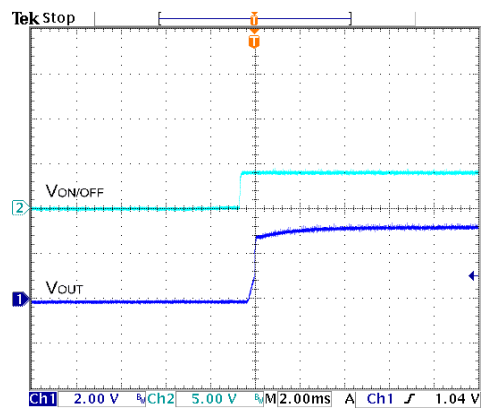

Using ON/OFF Voltage Start-Up and Vo Rise Characteristic  
Vin=Vin(nom), Full Load

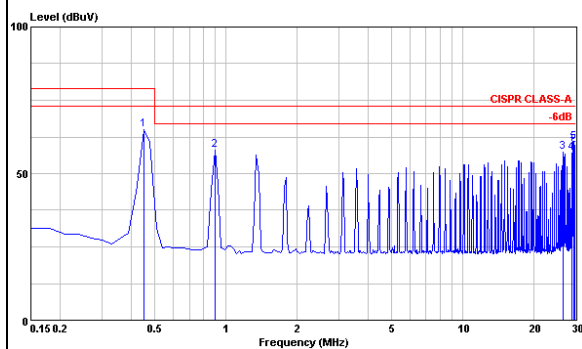

Conduction Emission of EN55022 Class A  
Vin=Vin(nom), Full Load

Characteristic Curves (Continued)

All test conditions are at 25°C. The figures are for PXD30-24WS05.

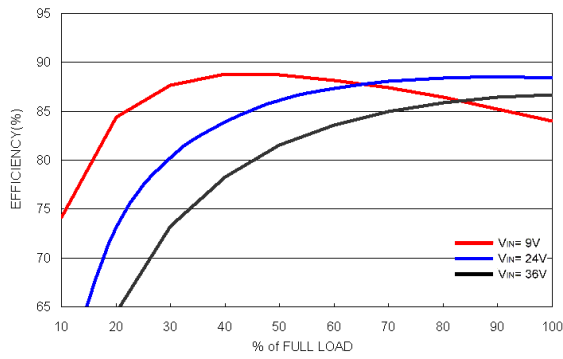

Efficiency Versus Output Current

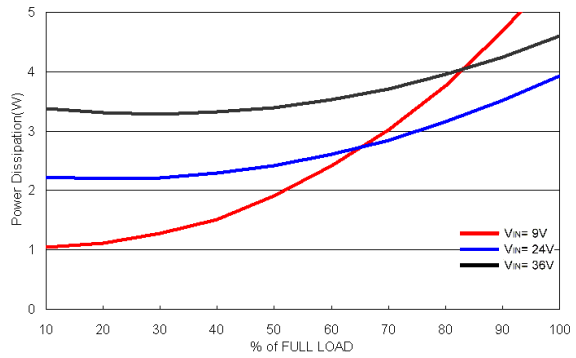

Power Dissipation Versus Output Current

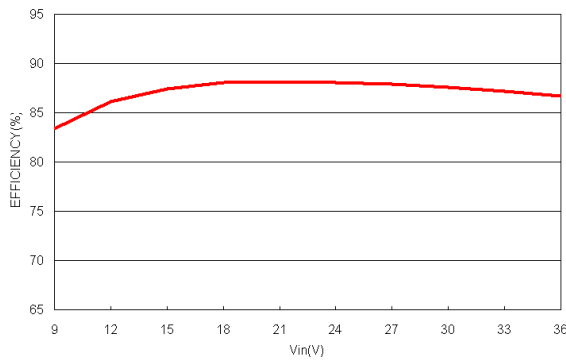

Efficiency Versus Input Voltage. Full Load

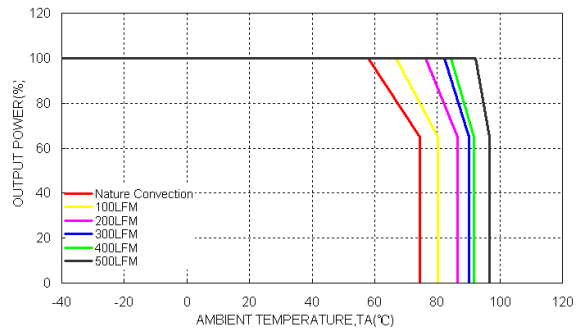

Derating Output Current Versus Ambient Temperature and Airflow  
 $V_{in} = V_{in}(nom)$

Characteristic Curves (Continued)

All test conditions are at 25°C. The figures are for PXD30-24WS05.

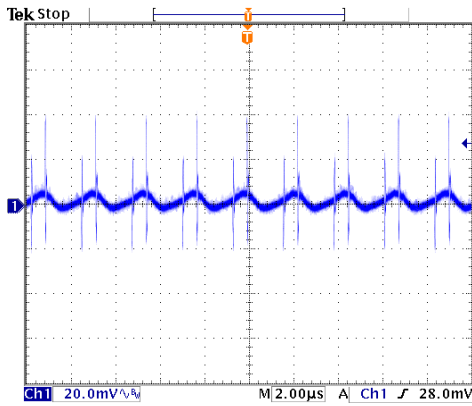

Typical Output Ripple and Noise.  
Vin=Vin(nom), Full Load

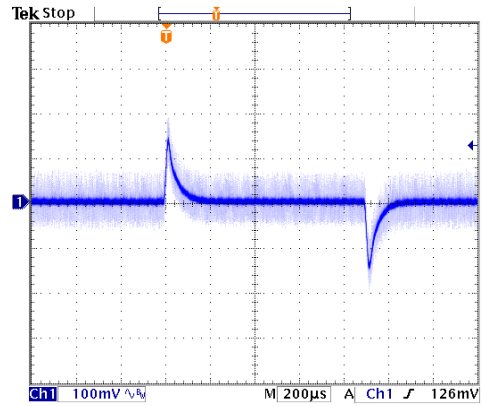

Transient Response to Dynamic Load Change from 100% to 75% to 100% of Full Load ; Vin=Vin(nom)

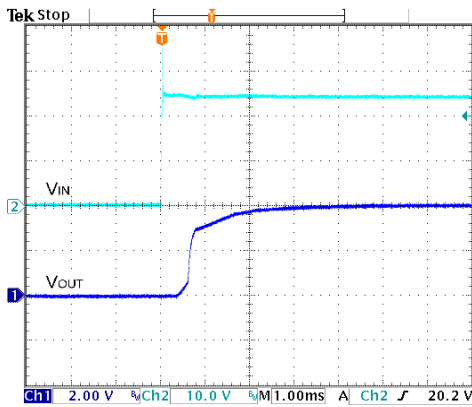

Typical Input Start-Up and Output Rise Characteristic  
Vin=Vin(nom), Full Load

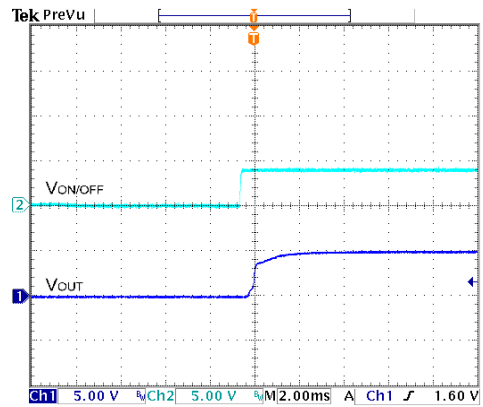

Using ON/OFF Voltage Start-Up and Vo Rise Characteristic  
Vin=Vin(nom), Full Load

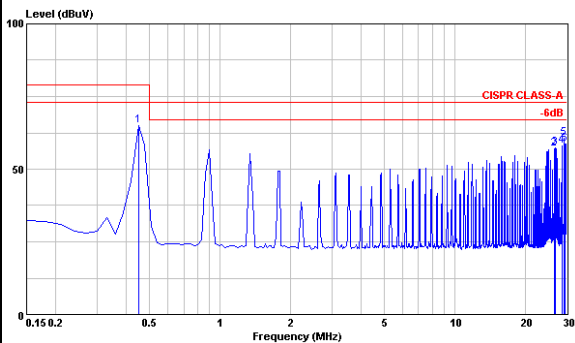

Conduction Emission of EN55022 Class A  
Vin=Vin(nom), Full Load

Characteristic Curves (Continued)

All test conditions are at 25°C. The figures are identical for PXD30-24WS5P1

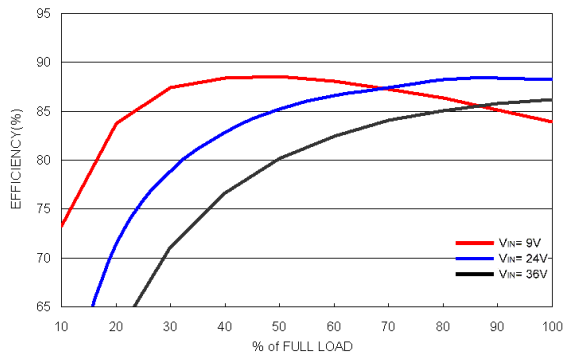

Efficiency Versus Output Current

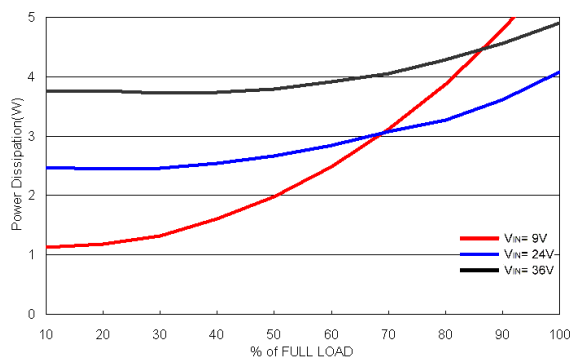

Power Dissipation Versus Output Current

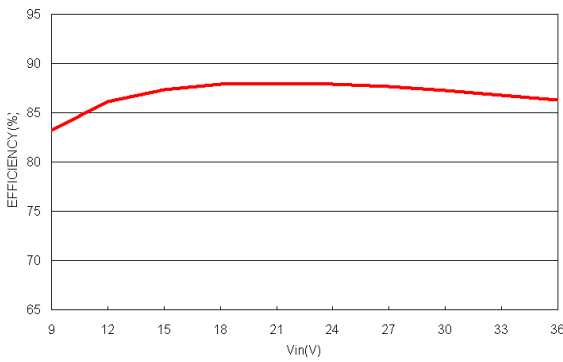

Efficiency Versus Input Voltage. Full Load

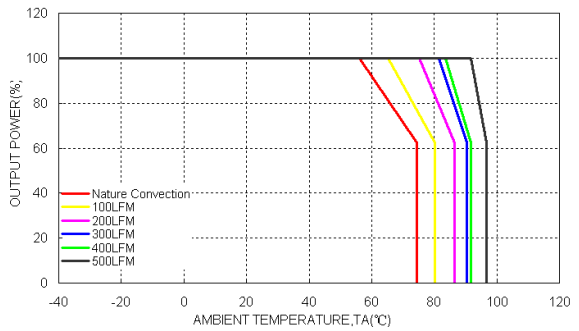

Derating Output Current Versus Ambient Temperature and Airflow  
 $V_{in}=V_{in}(nom)$

Characteristic Curves (Continued)

All test conditions are at 25°C . The figures are for PXD30-24WS5P1

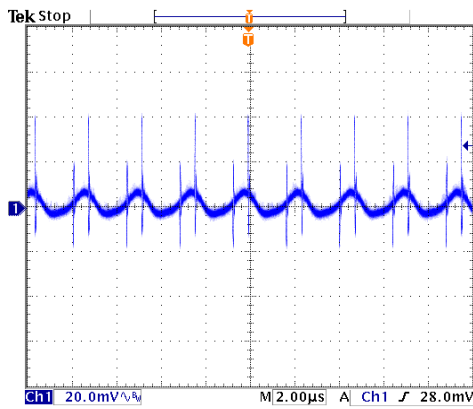

Typical Output Ripple and Noise.  
Vin=Vin(nom), Full Load

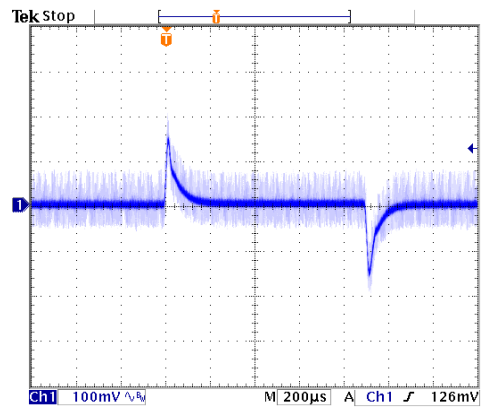

Transient Response to Dynamic Load Change from 100% to 75% to 100% of Full Load ; Vin=Vin(nom)

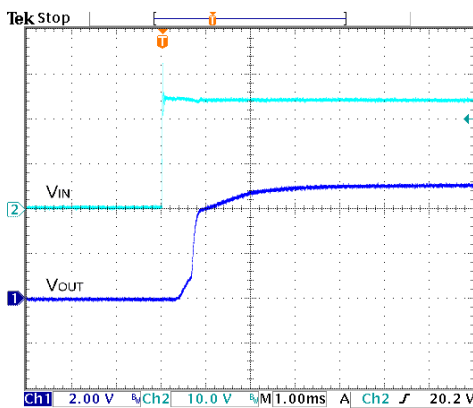

Typical Input Start-Up and Output Rise Characteristic  
Vin=Vin(nom), Full Load

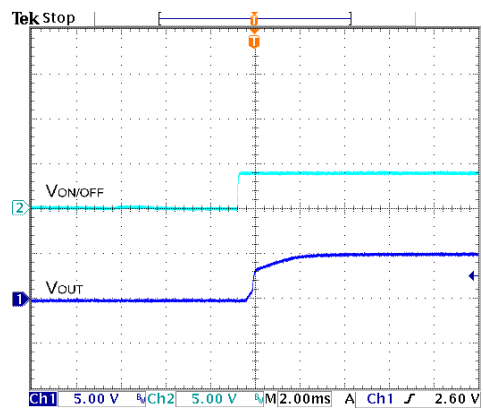

Using ON/OFF Voltage Start-Up and Vo Rise Characteristic  
Vin=Vin(nom), Full Load

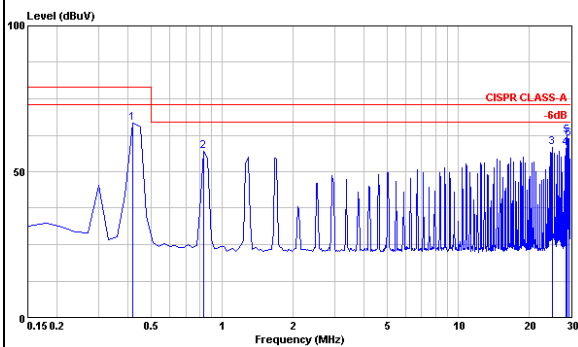

Conduction Emission of EN55022 Class A  
Vin=Vin(nom), Full Load

Characteristic Curves (Continued)

All test conditions are at 25°C .The figures are for PXD30-24WS12.

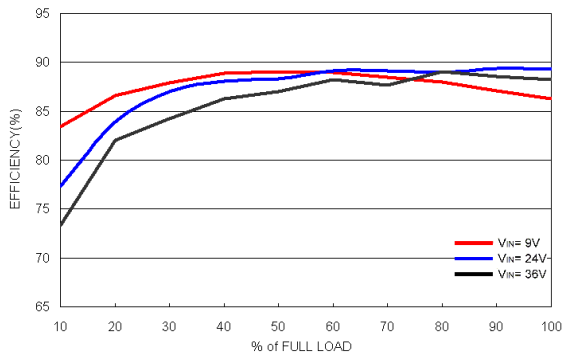

Efficiency Versus Output Current

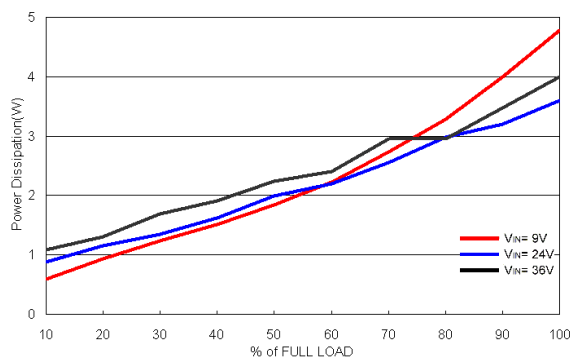

Power Dissipation Versus Output Current

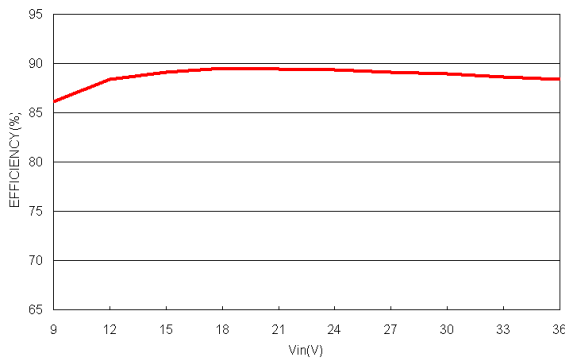

Efficiency Versus Input Voltage. Full Load

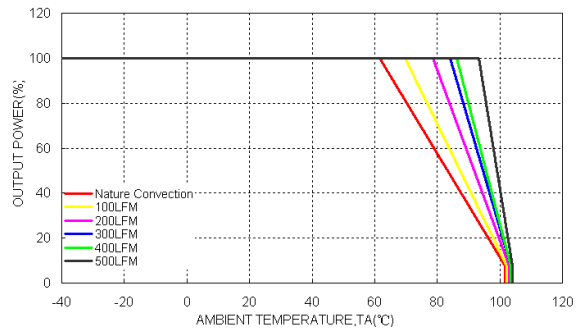

Derating Output Current Versus Ambient Temperature and Airflow  
 $V_{in}=V_{in}(nom)$

Characteristic Curves (Continued)

All test conditions are at 25°C . The figures are for PXD30-24WS12

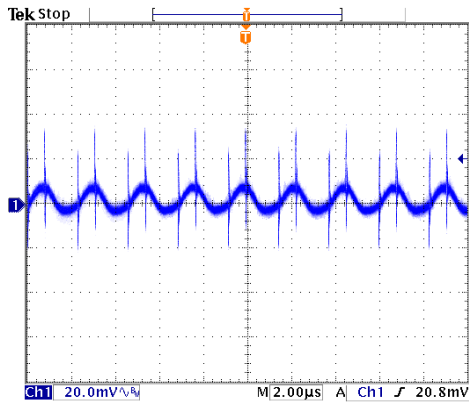

Typical Output Ripple and Noise.  
Vin=Vin(nom), Full Load

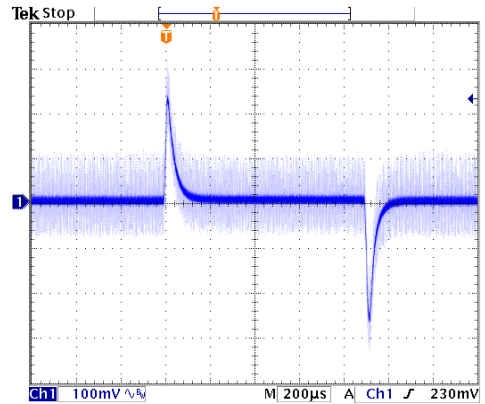

Transient Response to Dynamic Load Change from 100% to 75% to 100% of Full Load ; Vin=Vin(nom)

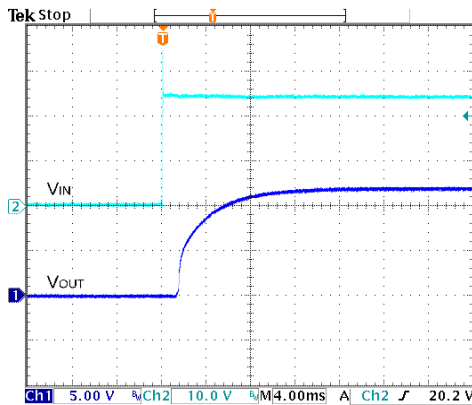

Typical Input Start-Up and Output Rise Characteristic  
Vin=Vin(nom), Full Load

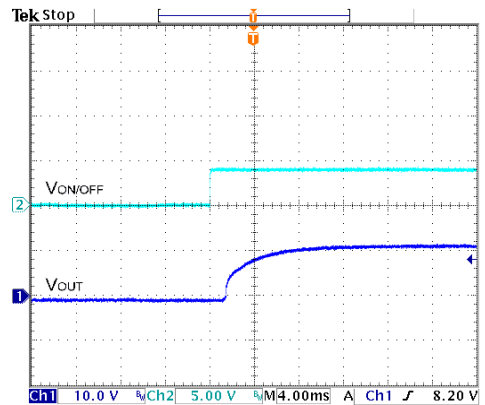

Using ON/OFF Voltage Start-Up and Vo Rise Characteristic  
Vin=Vin(nom), Full Load

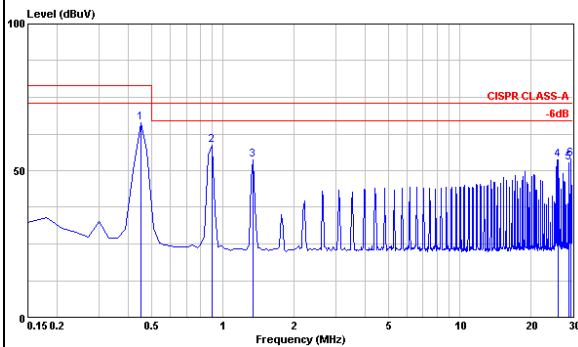

Conduction Emission of EN55022 Class A  
Vin=Vin(nom), Full Load



Characteristic Curves (Continued)

All test conditions are at 25°C .The figures are for PXD30-24WS15

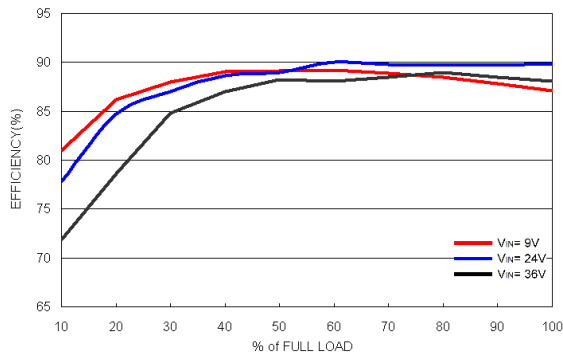

Efficiency Versus Output Current

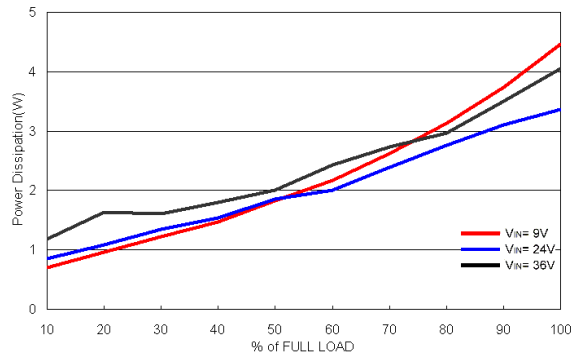

Power Dissipation Versus Output Current

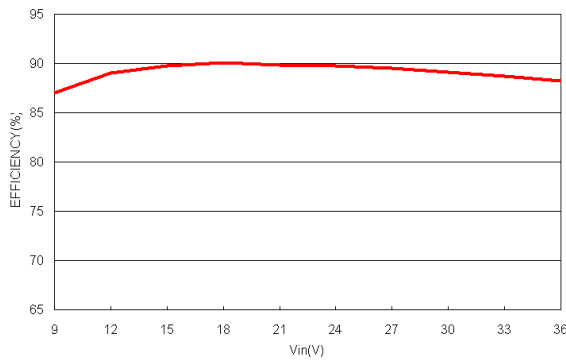

Efficiency Versus Input Voltage. Full Load

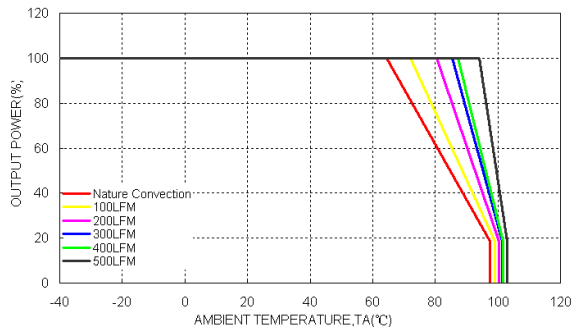

Derating Output Current Versus Ambient Temperature and Airflow  
 $V_{in}=V_{in}(nom)$

Characteristic Curves (Continued)

All test conditions are at 25°C . The figures are for PXD30-24WS15

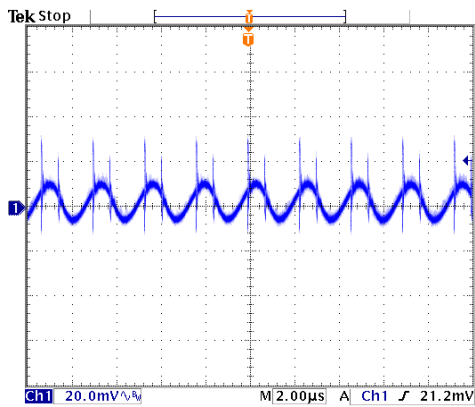

Typical Output Ripple and Noise.  
Vin=Vin(nom), Full Load

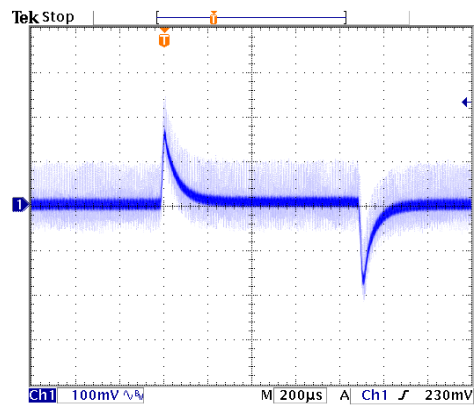

Transient Response to Dynamic Load Change from 100% to 75% to 100% of Full Load ; Vin=Vin(nom)

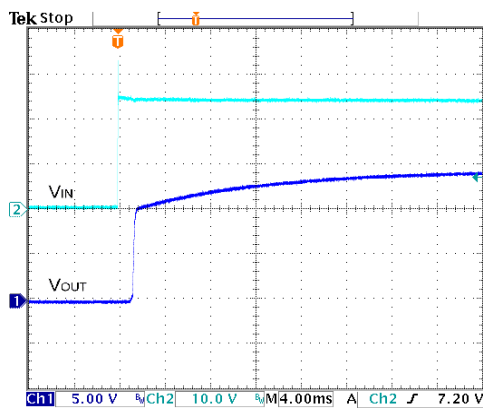

Typical Input Start-Up and Output Rise Characteristic  
Vin=Vin(nom), Full Load

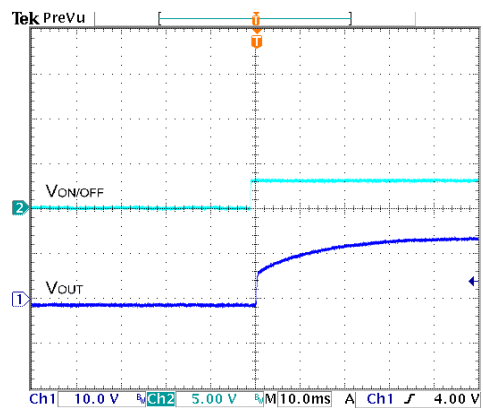

Using ON/OFF Voltage Start-Up and Vo Rise Characteristic  
Vin=Vin(nom), Full Load

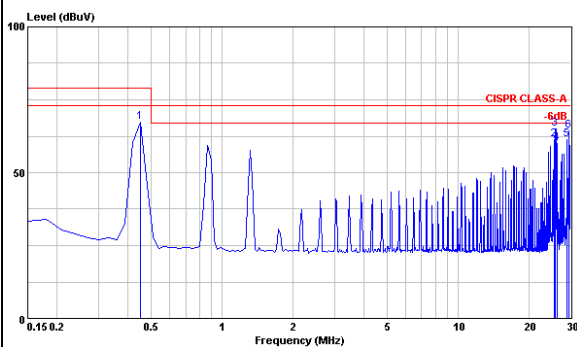

Conduction Emission of EN55022 Class A  
Vin=Vin(nom), Full Load

Characteristic Curves (Continued)

All test conditions are at 25°C .The figures are for PXD30-48WS1P5

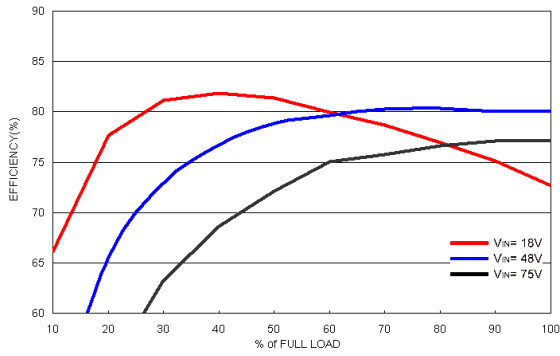

Efficiency Versus Output Current

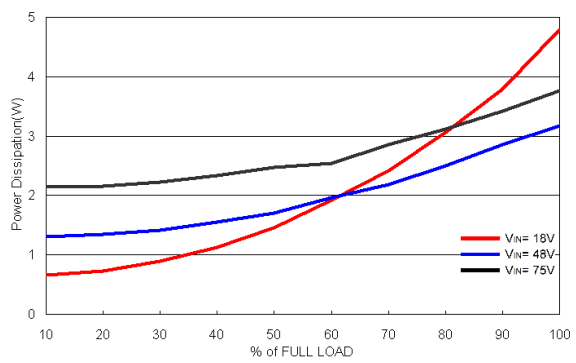

Power Dissipation Versus Output Current

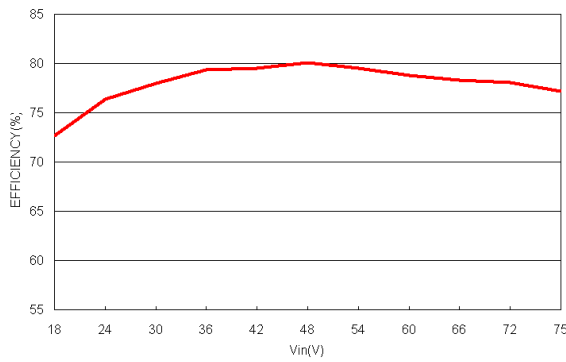

Efficiency Versus Input Voltage. Full Load

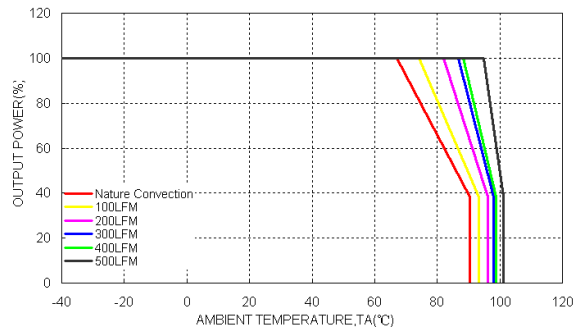

Derating Output Current Versus Ambient Temperature and Airflow  
Vin=Vin(nom)

Characteristic Curves (Continued)

All test conditions are at 25°C . The figures are for PXD30-48WS1P5

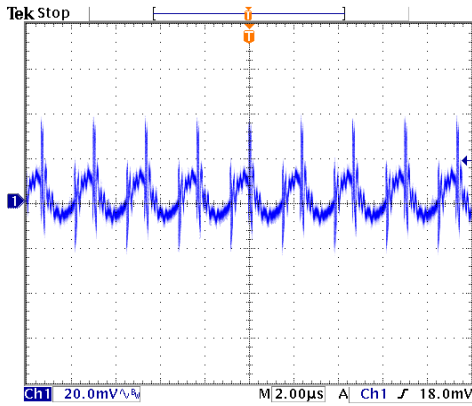

Typical Output Ripple and Noise.  
Vin=Vin(nom), Full Load

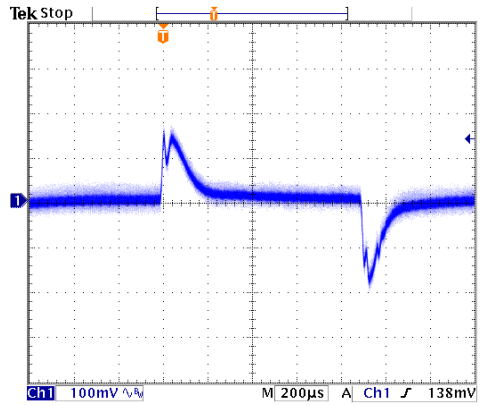

Transient Response to Dynamic Load Change from 100% to 75% to 100% of Full Load ; Vin=Vin(nom)

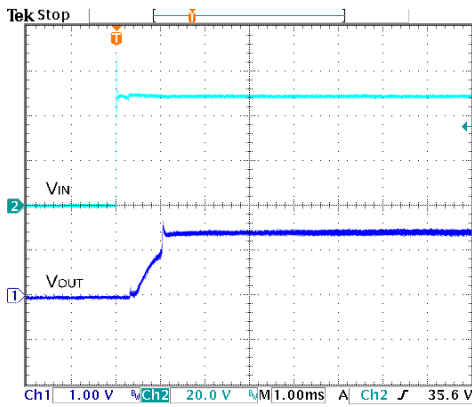

Typical Input Start-Up and Output Rise Characteristic  
Vin=Vin(nom), Full Load

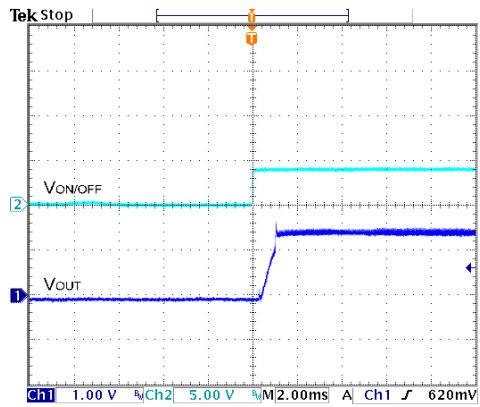

Using ON/OFF Voltage Start-Up and Vo Rise Characteristic  
Vin=Vin(nom), Full Load

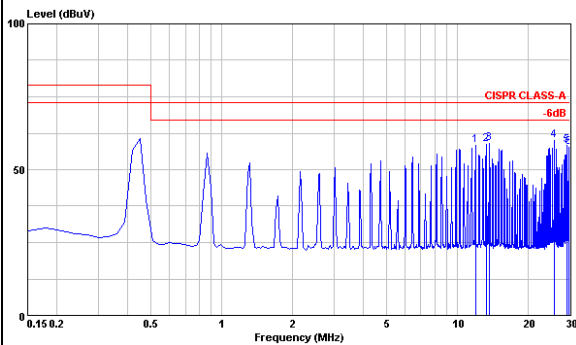

Conduction Emission of EN55022 Class A  
Vin=Vin(nom), Full Load

Characteristic Curves (Continued)

All test conditions are at 25°C .The figures are for PXD30-48WS2P5

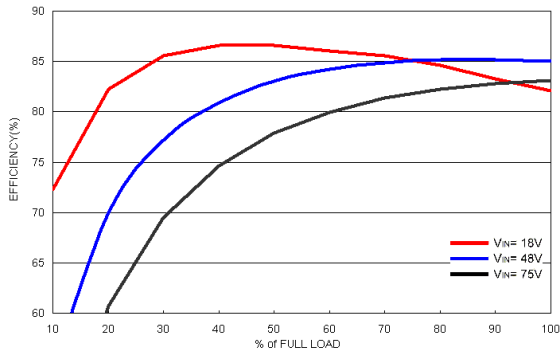

Efficiency Versus Output Current

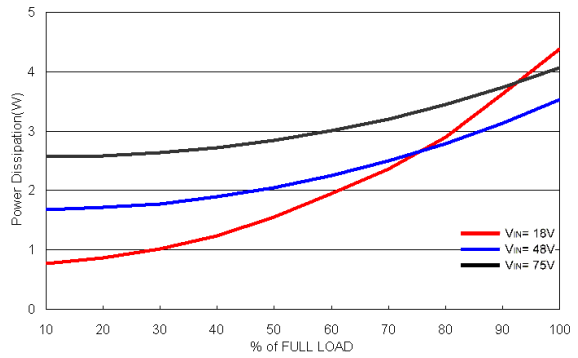

Power Dissipation Versus Output Current

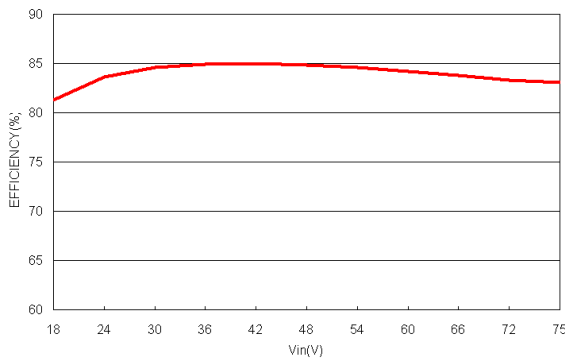

Efficiency Versus Input Voltage. Full Load

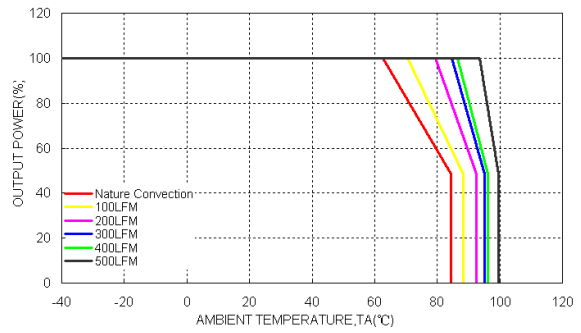

Derating Output Current Versus Ambient Temperature and Airflow  
Vin=Vin(nom)

Characteristic Curves (Continued)

All test conditions are at 25°C. The figures are for PXD30-48WS2P5

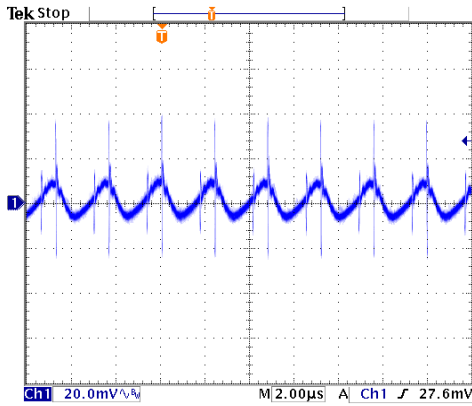

Typical Output Ripple and Noise.  
Vin=Vin(nom), Full Load

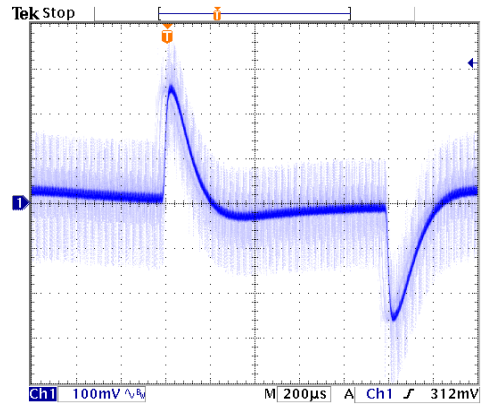

Transient Response to Dynamic Load Change from 100% to 75% to 100% of Full Load ; Vin=Vin(nom)

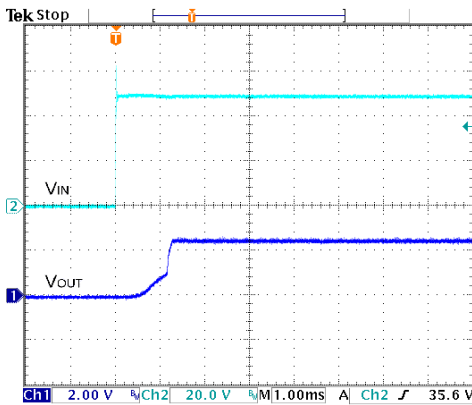

Typical Input Start-Up and Output Rise Characteristic  
Vin=Vin(nom), Full Load

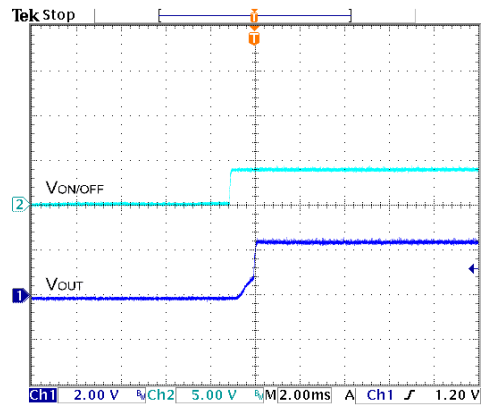

Using ON/OFF Voltage Start-Up and Vo Rise Characteristic  
Vin=Vin(nom), Full Load

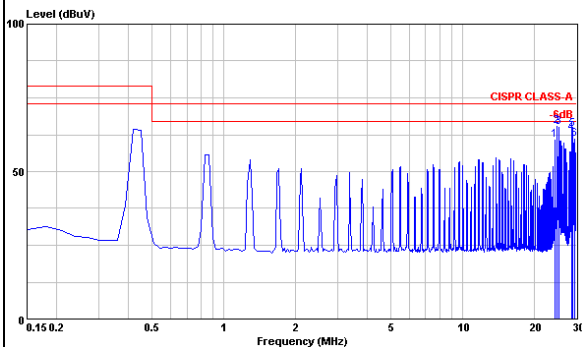

Conduction Emission of EN55022 Class A  
Vin=Vin(nom), Full Load

Characteristic Curves (Continued)

All test conditions are at 25°C .The figures are for PXD30-48WS3P3

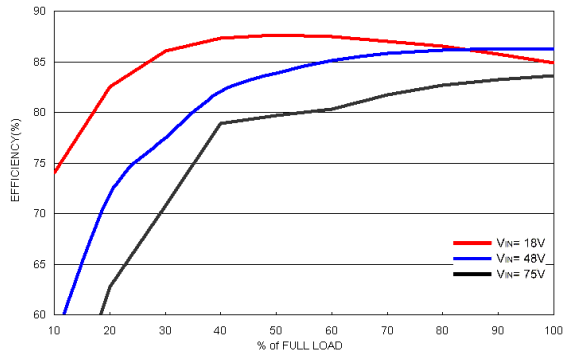

Efficiency Versus Output Current

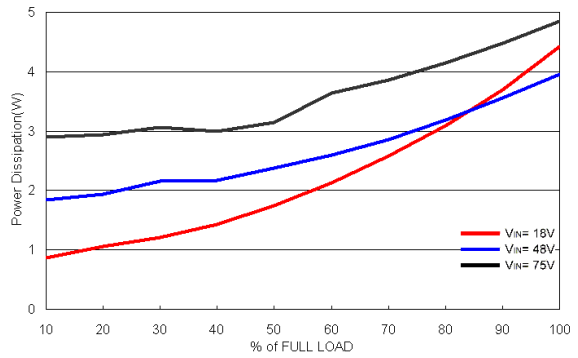

Power Dissipation Versus Output Current

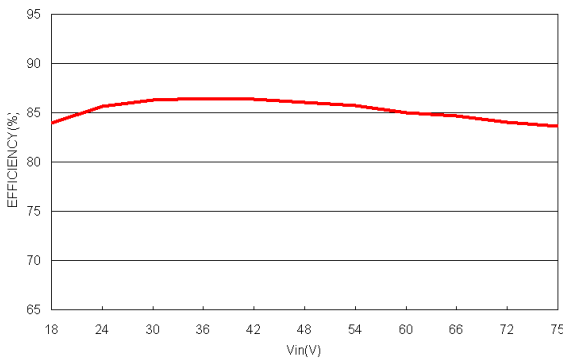

Efficiency Versus Input Voltage. Full Load

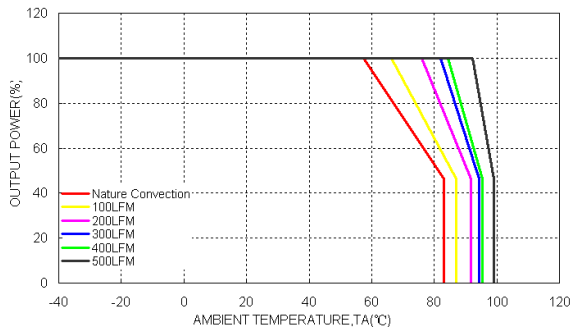

Derating Output Current Versus Ambient Temperature and Airflow  
Vin=Vin(nom)

Characteristic Curves (Continued)

All test conditions are at 25°C . The figures are for PXD30-48WS3P3

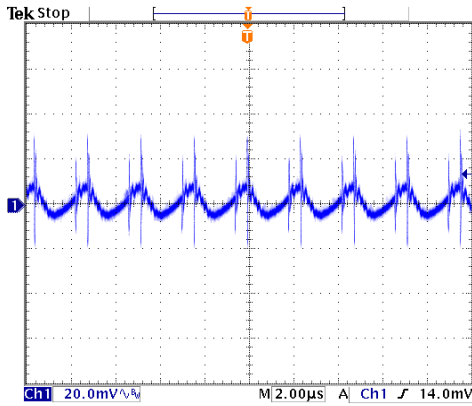

Typical Output Ripple and Noise.  
Vin=Vin(nom), Full Load

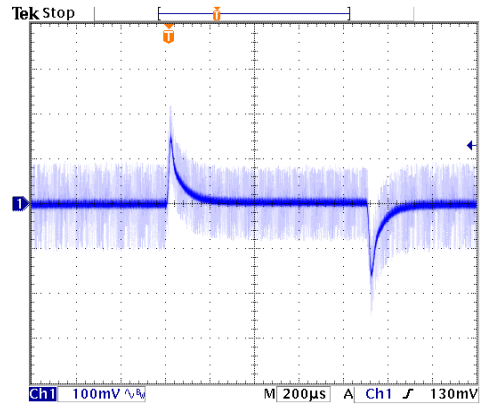

Transient Response to Dynamic Load Change from 100% to 75% to 100% of Full Load ; Vin=Vin(nom)

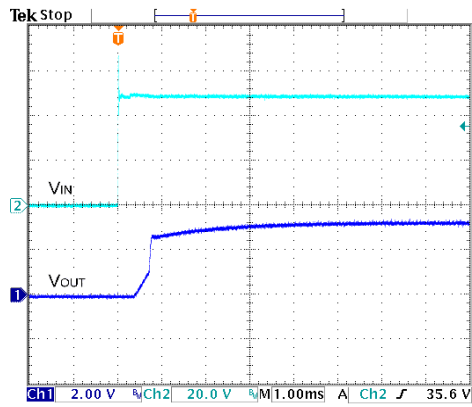

Typical Input Start-Up and Output Rise Characteristic  
Vin=Vin(nom), Full Load

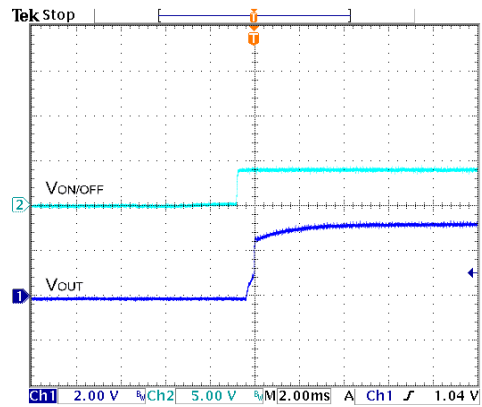

Using ON/OFF Voltage Start-Up and Vo Rise Characteristic  
Vin=Vin(nom), Full Load

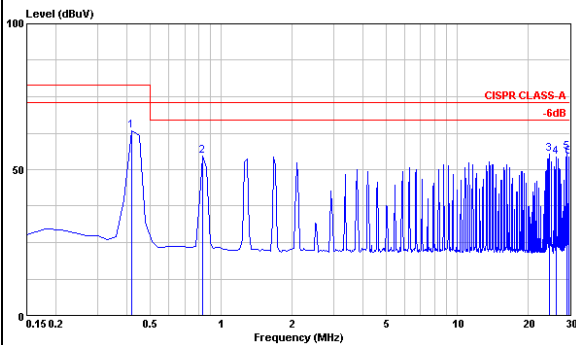

Conduction Emission of EN55022 Class A  
Vin=Vin(nom), Full Load



Characteristic Curves (Continued)

All test conditions are at 25°C .The figures are for PXD30-48WS05

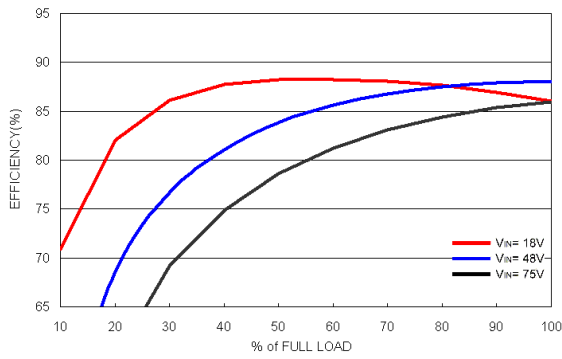

Efficiency Versus Output Current

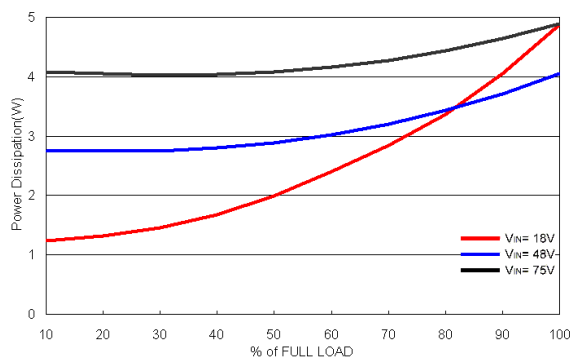

Power Dissipation Versus Output Current

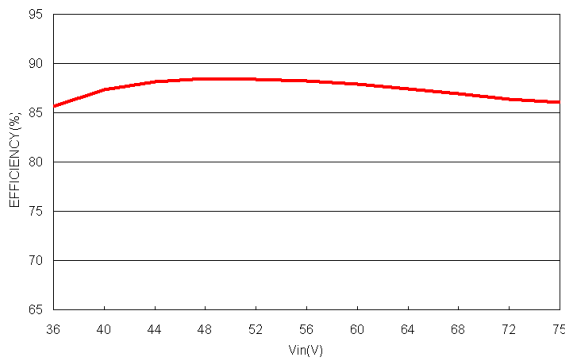

Efficiency Versus Input Voltage. Full Load

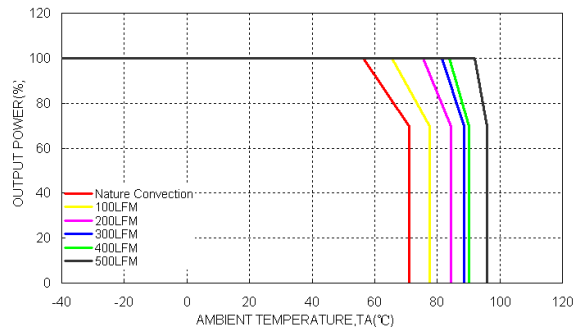

Derating Output Current Versus Ambient Temperature and Airflow  
Vin=Vin(nom)

Characteristic Curves (Continued)

All test conditions are at 25°C . The figures are for PXD30-48WS05

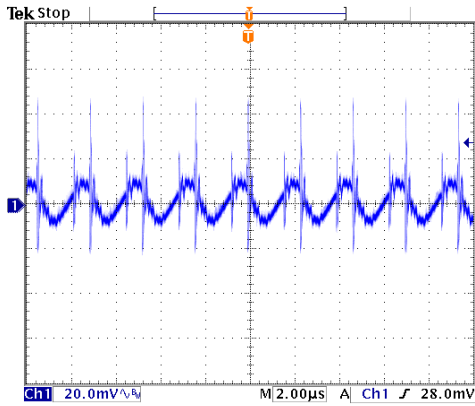

Typical Output Ripple and Noise.  
Vin=Vin(nom), Full Load

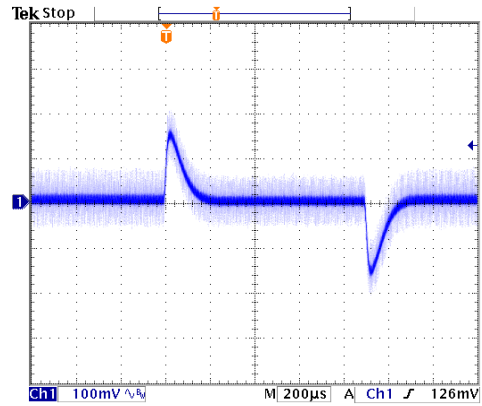

Transient Response to Dynamic Load Change from 100% to 75% to 100% of Full Load ; Vin=Vin(nom)

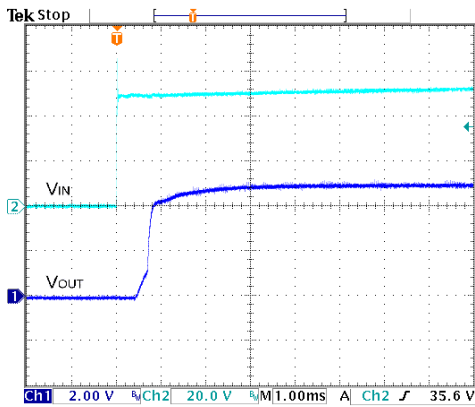

Typical Input Start-Up and Output Rise Characteristic  
Vin=Vin(nom), Full Load

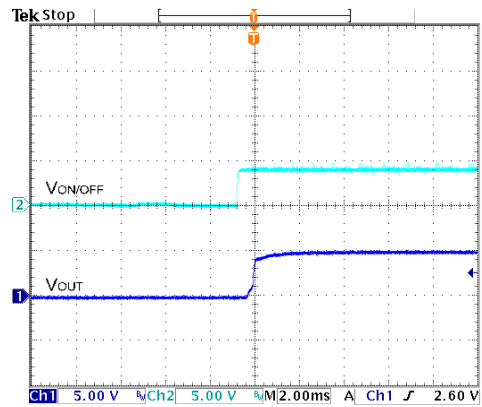

Using ON/OFF Voltage Start-Up and Vo Rise Characteristic  
Vin=Vin(nom), Full Load

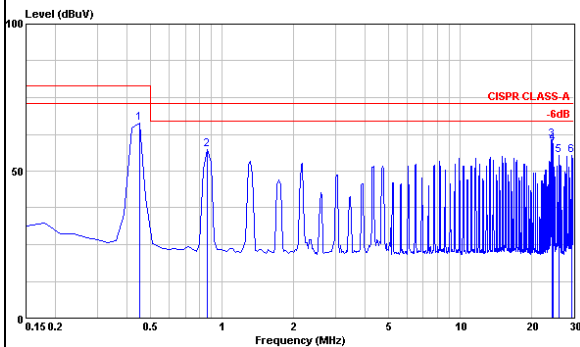

Conduction Emission of EN55022 Class A  
Vin=Vin(nom), Full Load

Characteristic Curves (Continued)

All test conditions are at 25°C. The figures are for PXD30-48WS5P1

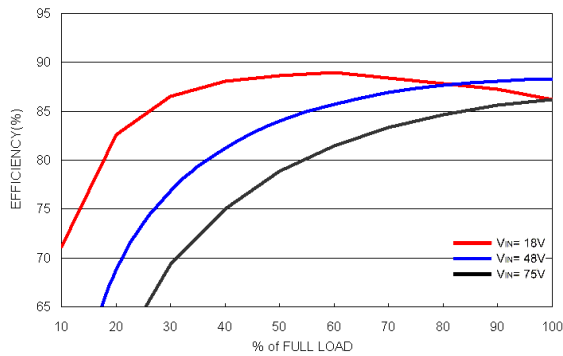

Efficiency Versus Output Current

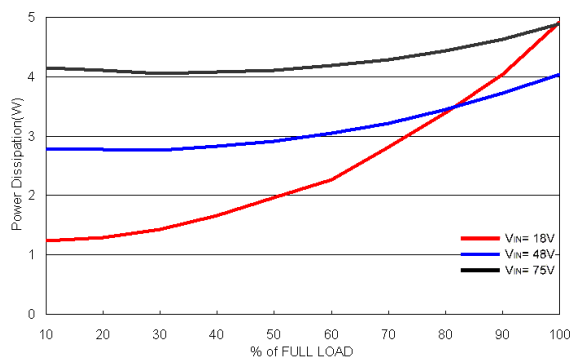

Power Dissipation Versus Output Current

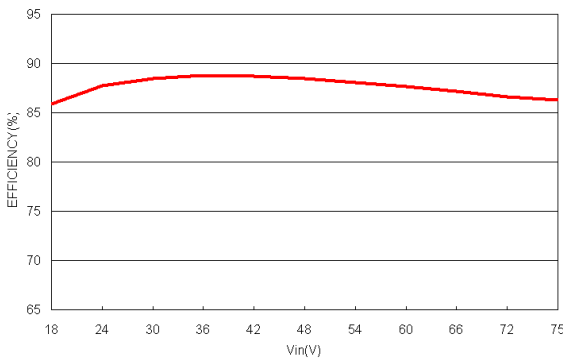

Efficiency Versus Input Voltage. Full Load

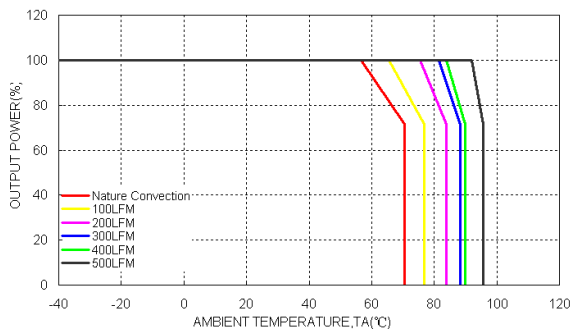

Derating Output Current Versus Ambient Temperature and Airflow  
Vin=Vin(nom)

Characteristic Curves (Continued)

All test conditions are at 25°C . The figures are for PXD30-48WS5P1.

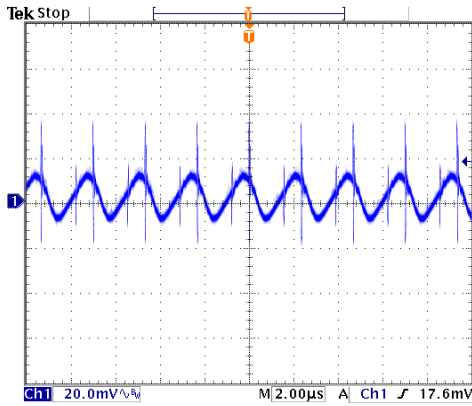

Typical Output Ripple and Noise.  
Vin=Vin(nom), Full Load

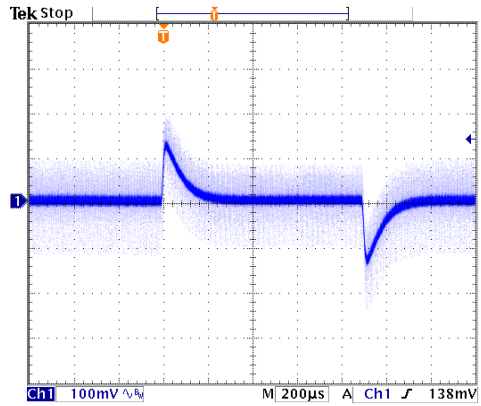

Transient Response to Dynamic Load Change from 100% to 75% to 100% of Full Load ; Vin=Vin(nom)

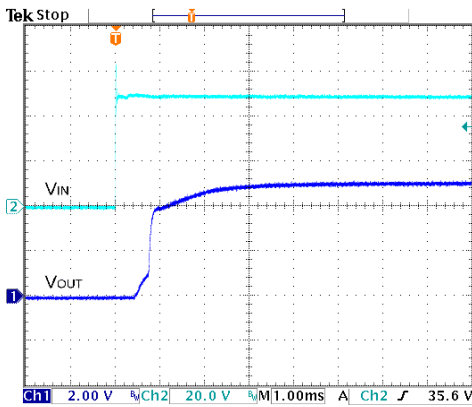

Typical Input Start-Up and Output Rise Characteristic  
Vin=Vin(nom), Full Load

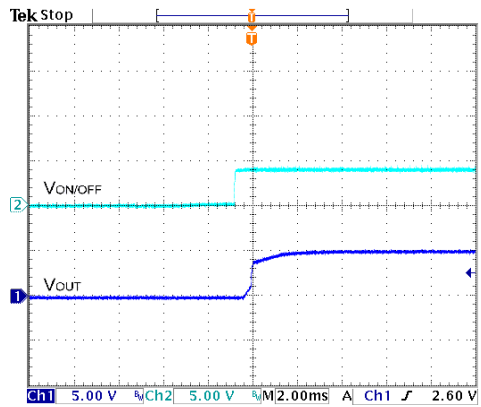

Using ON/OFF Voltage Start-Up and Vo Rise Characteristic  
Vin=Vin(nom), Full Load

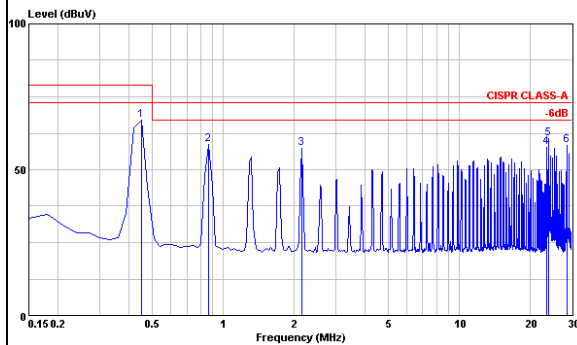

Conduction Emission of EN55022 Class A  
Vin=Vin(nom), Full Load

Characteristic Curves (Continued)

All test conditions are at 25°C .The figures are for PXD30-48WS12.

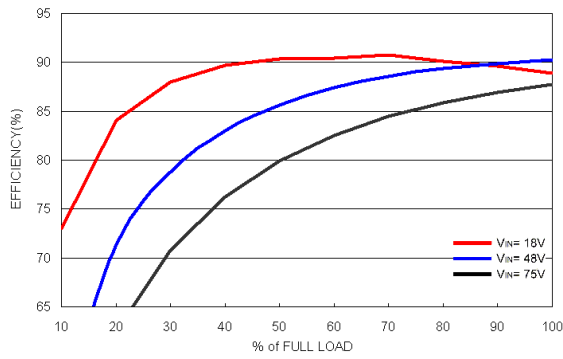

Efficiency Versus Output Current

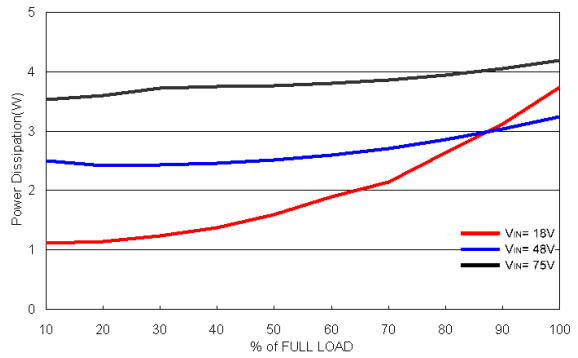

Power Dissipation Versus Output Current

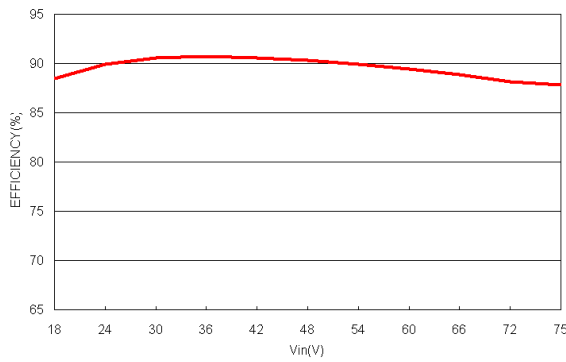

Efficiency Versus Input Voltage. Full Load

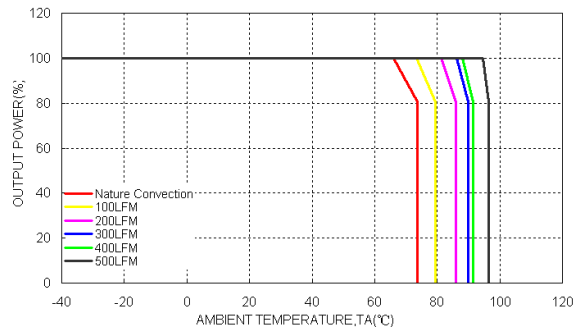

Derating Output Current Versus Ambient Temperature and Airflow  
Vin=Vin(nom)

Characteristic Curves (Continued)

All test conditions are at 25°C . The figures are for PXD30-48WS12

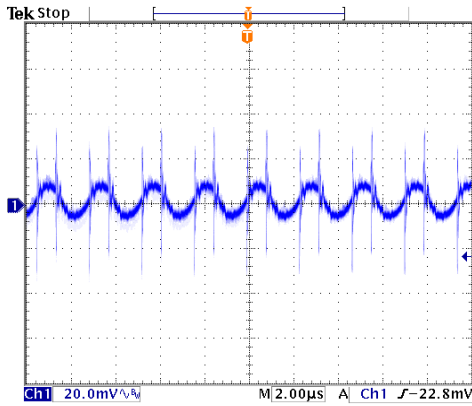

Typical Output Ripple and Noise.  
Vin=Vin(nom), Full Load

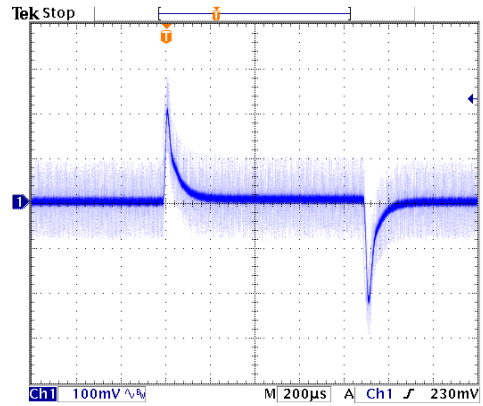

Transient Response to Dynamic Load Change from 100% to 75% to 100% of Full Load ; Vin=Vin(nom)

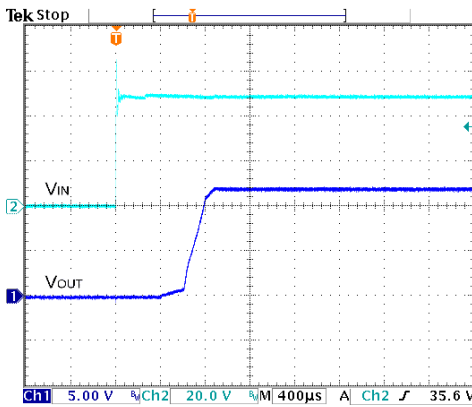

Typical Input Start-Up and Output Rise Characteristic  
Vin=Vin(nom), Full Load

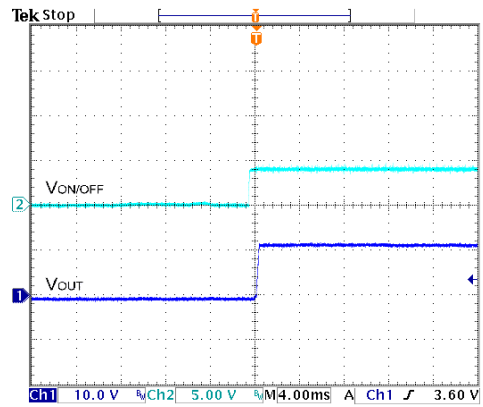

Using ON/OFF Voltage Start-Up and Vo Rise Characteristic  
Vin=Vin(nom), Full Load

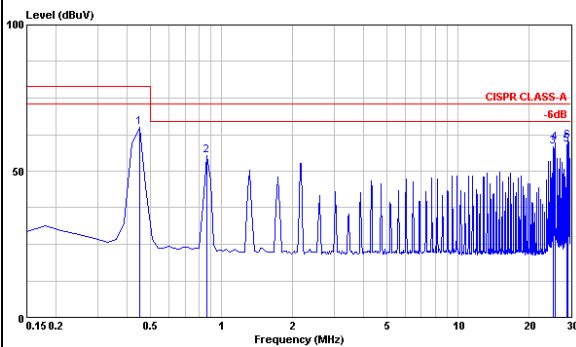

Conduction Emission of EN55022 Class A  
Vin=Vin(nom), Full Load

Characteristic Curves (Continued)

All test conditions are at 25°C .The figures are for PXD30-48WS15.

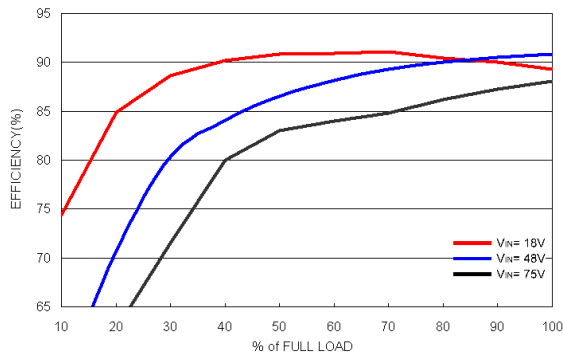

Efficiency Versus Output Current

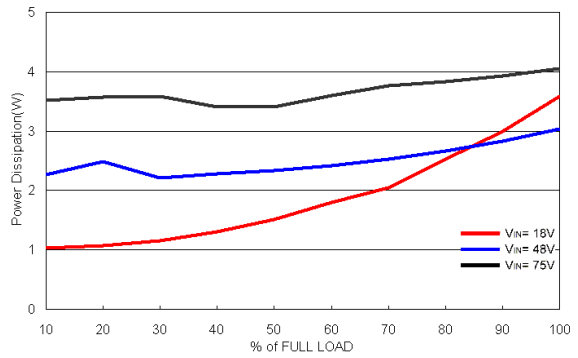

Power Dissipation Versus Output Current

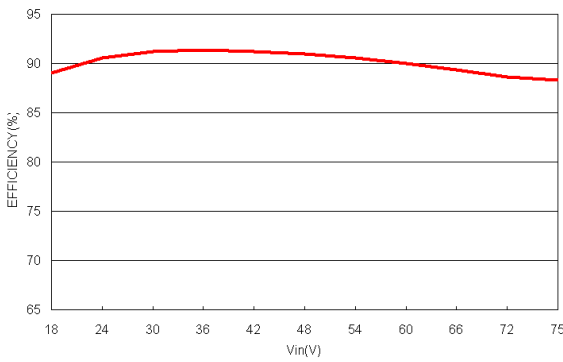

Efficiency Versus Input Voltage. Full Load

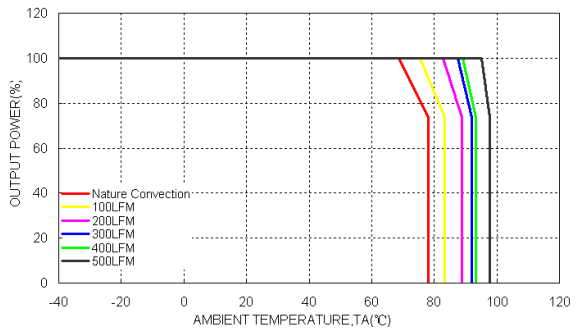

Derating Output Current Versus Ambient Temperature and Airflow  
Vin=Vin(nom)

Characteristic Curves (Continued)

All test conditions are at 25°C . The figures are for PXD30-48WS15

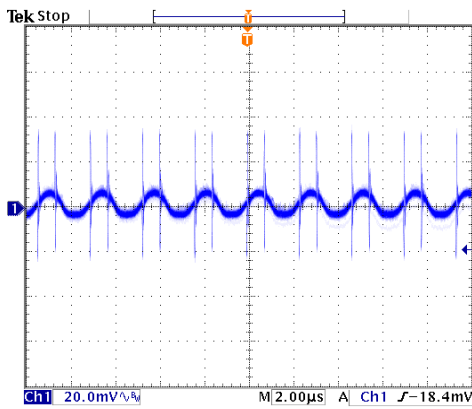

Typical Output Ripple and Noise.  
Vin=Vin(nom), Full Load

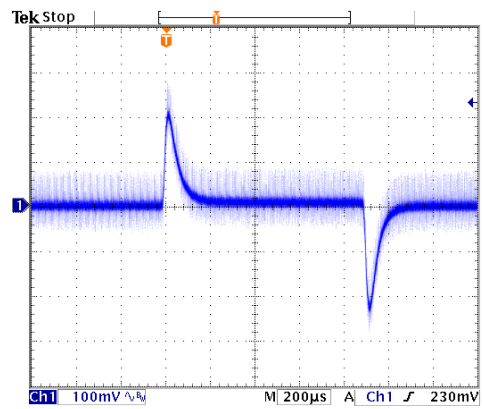

Transient Response to Dynamic Load Change from 100% to 75% to 100% of Full Load ; Vin=Vin(nom)

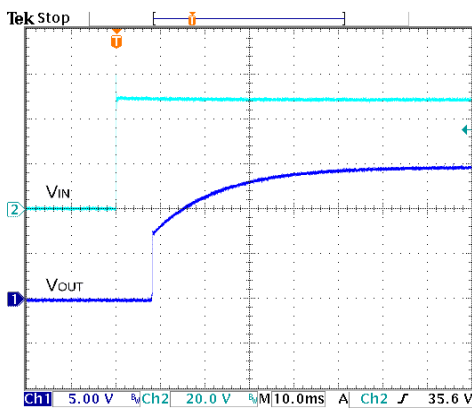

Typical Input Start-Up and Output Rise Characteristic  
Vin=Vin(nom), Full Load

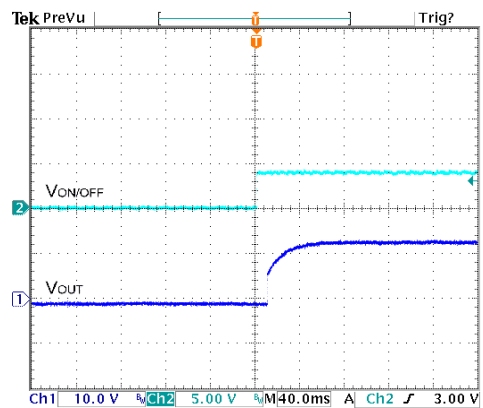

Using ON/OFF Voltage Start-Up and Vo Rise Characteristic  
Vin=Vin(nom), Full Load

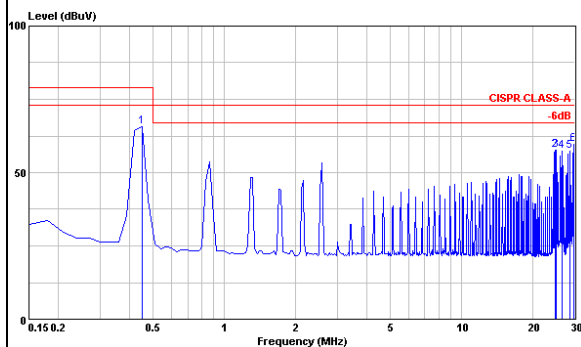

Conduction Emission of EN55022 Class A  
Vin=Vin(nom), Full Load



Testing Configurations

Input reflected-ripple current measurement test:

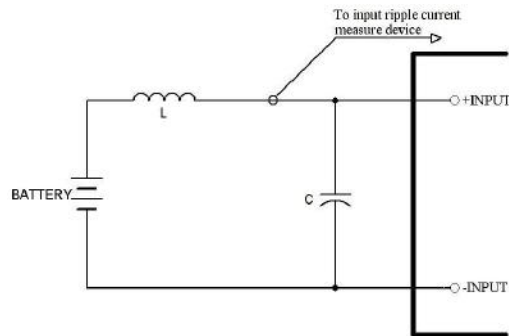

Component	Value	Voltage	Reference
L	12μH	---	---
C	47μF	100V	Aluminum Electrolytic Capacitor

Peak-to-peak output ripple & noise measurement test:

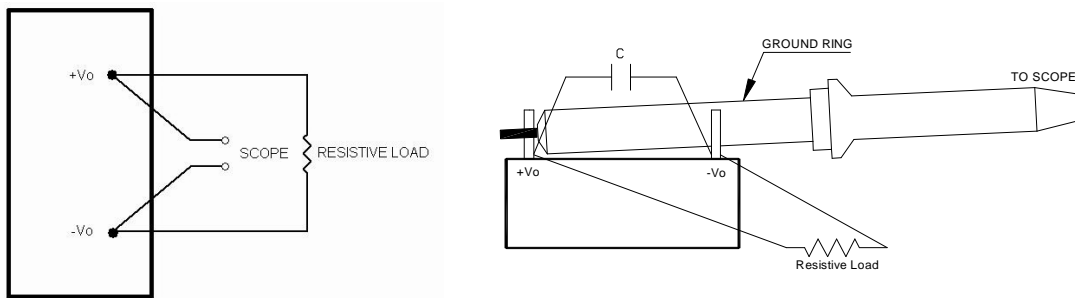

Output voltage and efficiency measurement test:

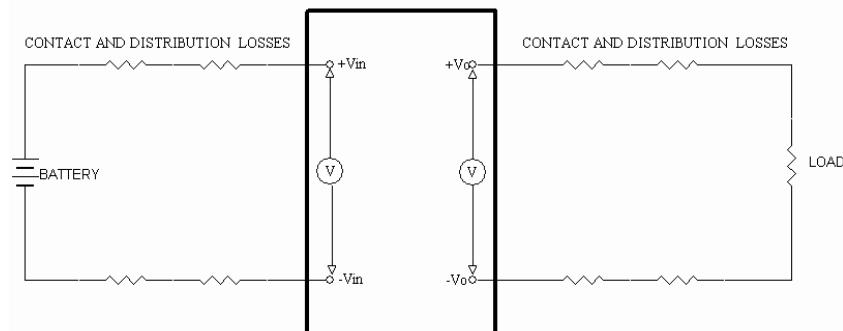

Note: All measurements are taken at the module terminals.

$$Efficiency = \left( \frac{V_o \times I_o}{V_{in} \times I_{in}} \right) \times 100\%$$

EMC Considerations

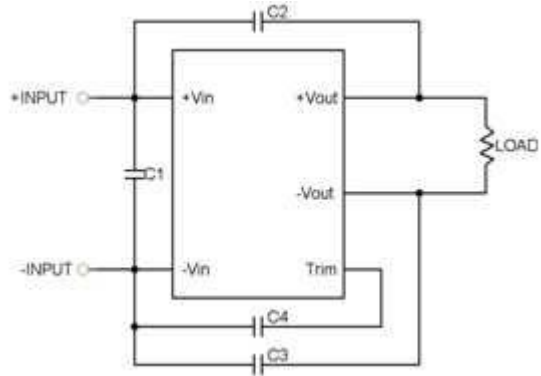

Suggested Schematic for EN55022 Conducted Emission Class A Limits

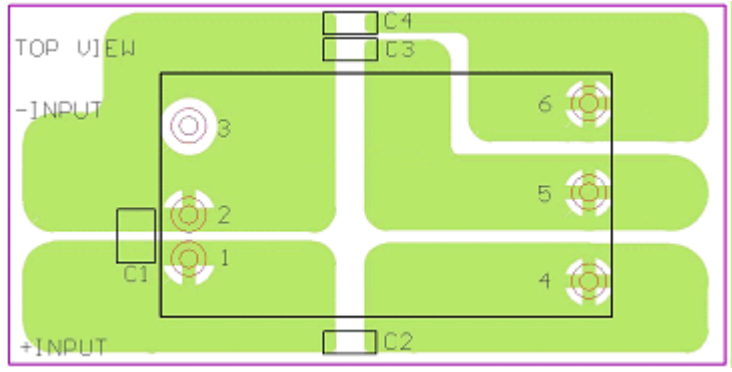

Recommended layout with input filter

To meet conducted emissions EN55022 CLASS A needed the following components:

PXD30-24WSxx

Component	Value	Voltage	Reference
C1	4.7uF	50V	1812 MLCC
C2,C3,C4	1000pF	2KV	1206 MLCC

PXD30-48WSxx

Component	Value	Voltage	Reference
C1	2.2uF	100V	1812 MLCC
C2,C3,C4	1000pF	2KV	1206 MLCC

#### Input Source Impedance

The converter should be connected to a low impedance input source. Highly inductive source impedance can affect the stability of the converter. Input external L-C filter is recommended to minimize input reflected ripple current. The inductor has a simulated source impedance of 12 $\mu$ H and the capacitor is Nippon chemi-con KY series 47 $\mu$ F/100V. The capacitor must be located as close as possible to the input terminals of the converter for lowest impedance.

#### Output Over Current Protection

When excessive output currents occur in the system, circuit protection is required on all converters. Normally, overload current is maintained at approximately 150 percent of rated current for PXD30-xxWSxx series.

Hiccup-mode is a method of operation in the converter whose purpose is to protect the converter from being damaged during an over-current fault condition. It also enables the converter to restart when the fault is removed.

One of the problems resulting from over current is that excessive heat may be generated in power devices; especially MOSFET and Schottky diodes and the temperature of those devices may exceed their specified limits. A protection mechanism has to be used to prevent those power devices from being damaged.

#### Output Over Voltage Protection

The output over-voltage protection consists of output Zener diode that monitors the voltage on the output terminals. If the voltage on the output terminals exceeds the over-voltage protection threshold, then the Zener diode clamps the output voltage.

#### Short Circuit Protection

Continuous, hiccup and auto-recovery mode.

Output Voltage Adjustment

Output voltage set point adjustment allows the user to increase or decrease the output voltage set point of a converter. This is accomplished by connecting an external resistor between the TRIM pin and either the Vo (+) or Vo (-) pins. With an external resistor between the TRIM and Vo (-) pin, the output voltage set point increases. With an external resistor between the TRIM and Vo (+) pin, the output voltage set point decreases.

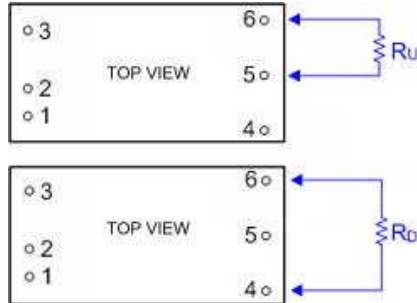

TRIM TABLE

PXD30-xxWS1P5

Trim up (%)	1	2	3	4	5	6	7	8	9	10
V <sub>OUT</sub> (Volts)=	1.515	1.530	1.545	1.560	1.575	1.590	1.605	1.620	1.635	1.650
R <sub>U</sub> (K Ohms)=	4.578	2.065	1.227	0.808	0.557	0.389	0.270	0.180	0.110	0.054
Trim down (%)	1	2	3	4	5	6	7	8	9	10
V <sub>OUT</sub> (Volts)=	1.485	1.470	1.455	1.440	1.425	1.410	1.395	1.380	1.365	1.350
R <sub>D</sub> (K Ohms)=	5.704	2.571	1.527	1.005	0.692	0.483	0.334	0.222	0.135	0.065

PXD30-xxWS2P5

Trim up (%)	1	2	3	4	5	6	7	8	9	10
V <sub>OUT</sub> (Volts)=	2.525	2.550	2.575	2.600	2.625	2.650	2.675	2.700	2.725	2.750
R <sub>U</sub> (K Ohms)=	37.076	16.675	9.874	6.474	4.434	3.074	2.102	1.374	0.807	0.354
Trim down (%)	1	2	3	4	5	6	7	8	9	10
V <sub>OUT</sub> (Volts)=	2.475	2.450	2.425	2.400	2.375	2.350	2.325	2.300	2.275	2.250
R <sub>D</sub> (K Ohms)=	49.641	22.481	13.428	8.902	6.186	4.375	3.082	2.112	1.358	0.754

PXD30-xxWS3P3

Trim up (%)	1	2	3	4	5	6	7	8	9	10
V <sub>OUT</sub> (Volts)=	3.333	3.366	3.399	3.432	3.465	3.498	3.531	3.564	3.597	3.630
R <sub>U</sub> (K Ohms)=	57.930	26.165	15.577	10.283	7.106	4.988	3.476	2.341	1.459	0.753
Trim down (%)	1	2	3	4	5	6	7	8	9	10
V <sub>OUT</sub> (Volts)=	3.267	3.234	3.201	3.168	3.135	3.102	3.069	3.036	3.003	2.970
R <sub>D</sub> (K Ohms)=	69.470	31.235	18.490	12.117	8.294	5.745	3.924	2.559	1.497	0.647

PXD30-xxWS05

Trim up (%)	1	2	3	4	5	6	7	8	9	10
V <sub>OUT</sub> (Volts)=	5.050	5.100	5.150	5.200	5.250	5.300	5.350	5.400	5.450	5.500
R <sub>U</sub> (K Ohms)=	36.570	16.580	9.917	6.585	4.586	3.253	2.302	1.588	1.032	0.588
Trim down (%)	1	2	3	4	5	6	7	8	9	10
V <sub>OUT</sub> (Volts)=	4.950	4.900	4.850	4.800	4.750	4.700	4.650	4.600	4.550	4.500
R <sub>D</sub> (K Ohms)=	45.533	20.612	12.306	8.152	5.660	3.999	2.812	1.922	1.230	0.676

Output Voltage Adjustment (Continued)										
TRIM TABLE ( Continued)										
PXD30-xxWS5P1										
Trim up (%)	1	2	3	4	5	6	7	8	9	10
V <sub>OUT</sub> (Volts)=	5.151	5.202	5.253	5.304	5.355	5.406	5.457	5.508	5.559	5.610
R <sub>U</sub> (K Ohms)=	38.135	17.368	10.446	6.985	4.908	3.524	2.535	1.793	1.217	0.755
Trim down (%)	1	2	3	4	5	6	7	8	9	10
V <sub>OUT</sub> (Volts)=	5.049	4.998	4.947	4.896	4.845	4.794	4.743	4.692	4.641	4.590
R <sub>D</sub> (K Ohms)=	47.191	21.431	12.844	8.551	5.975	4.258	3.031	2.111	1.396	0.823
PXD30-xxWS12										
Trim up (%)	1	2	3	4	5	6	7	8	9	10
V <sub>OUT</sub> (Volts)=	12.120	12.240	12.360	12.480	12.600	12.720	12.840	12.960	13.080	13.200
R <sub>U</sub> (K Ohms)=	367.908	165.954	98.636	64.977	44.782	31.318	21.701	14.488	8.879	4.391
Trim down (%)	1	2	3	4	5	6	7	8	9	10
V <sub>OUT</sub> (Volts)=	11.880	11.760	11.640	11.520	11.400	11.280	11.160	11.040	10.920	10.800
R <sub>D</sub> (K Ohms)=	460.992	207.946	123.597	81.423	56.118	39.249	27.199	18.162	11.132	5.509
PXD30-xxWS15										
Trim up (%)	1	2	3	4	5	6	7	8	9	10
V <sub>OUT</sub> (Volts)=	15.150	15.300	15.450	15.600	15.750	15.900	16.050	16.200	16.350	16.500
R <sub>U</sub> (K Ohms)=	404.184	180.592	106.061	68.796	46.437	31.531	20.883	12.898	6.687	1.718
Trim down (%)	1	2	3	4	5	6	7	8	9	10
V <sub>OUT</sub> (Volts)=	14.850	14.700	14.550	14.400	14.250	14.100	13.950	13.800	13.650	13.500
R <sub>D</sub> (K Ohms)=	499.816	223.408	131.272	85.204	57.563	39.136	25.974	16.102	8.424	2.282

### Thermal Consideration

The converter operates in a variety of thermal environments.; however, sufficient cooling should be provided to help ensure reliable operation of the unit. Heat is removed by conduction, convection, and radiation to the surrounding environment. Proper cooling can be verified by measuring the point as shown in the figure below. The temperature at this location should not exceed 105°C. When operating, adequate cooling must be provided to maintain the test point temperature at or below 105°C. Although the maximum point temperature of the power modules is 105°C, limiting this temperature to a lower value will increase the reliability of this device.

Measurement shown in inches (mm) TOP VIEW

### Heat Sink Consideration

Use heat-sink (7G-0020C) for lowering temperature; thus increasing the reliability of the converter.

#### Heatsink + Clamp

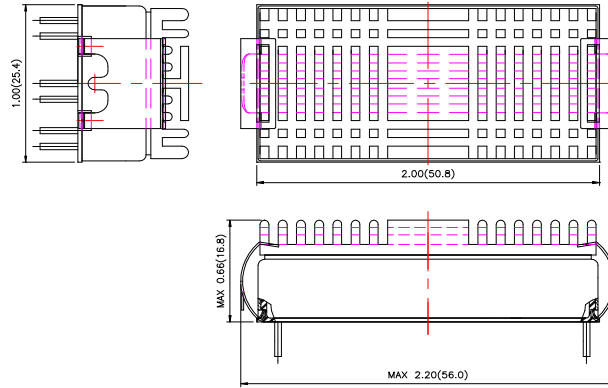

#### Heatsink

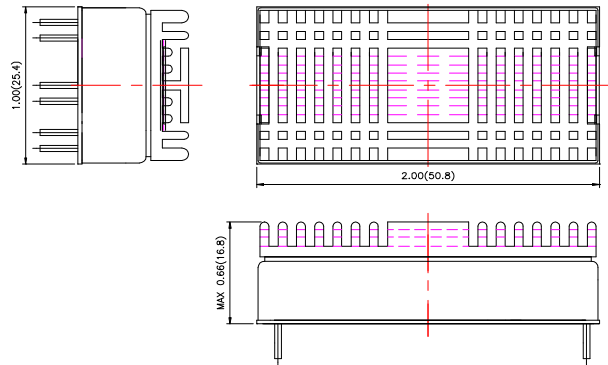

Measurement shown in inches and (millimeters)

**Remote ON/OFF Control**

Positive Logic – (no suffix) , the positive logic remote ON/OFF control circuit is included. Ex.: PXD30-24WS05

Turns the converter ON during logic High on the On/Off pin and turns the converter OFF during logic Low.

The On/Off pin is an open collector/drain logic input signal ( $V_{on/off}$ ) that is referenced to GND.

If not using the remote on/off feature, an open circuit between on/off pin and (-) input pin is needed to turn the module on.

Negative Logic – (suffix -N), the negative logic remote ON/OFF control circuit is included. Ex.:

PXD30-24WS05-N

Turns the converter ON during logic Low on the On/Off pin and turns the converter OFF during logic High.

The On/Off pin is an open collector/drain logic input signal ( $V_{on/off}$ ) that is referenced to GND.

If not using the remote on/off feature, a short circuit between on/off pin and (-) input pin is needed to turn the module on.

Remote ON/OFF Implementation

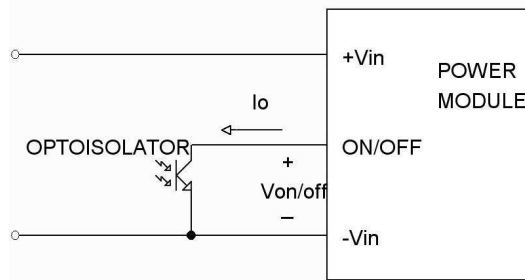

Isolated-Control Remote ON/OFF

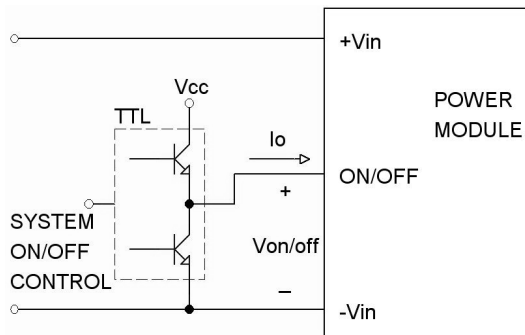

Level Control Using TTL Output

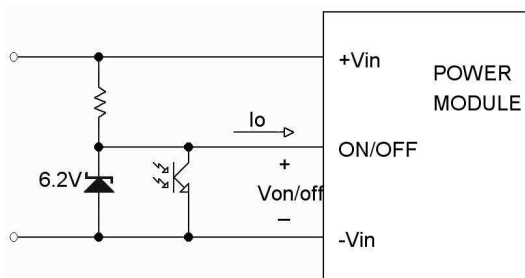

Level Control Using Line Voltage



Mechanical Data

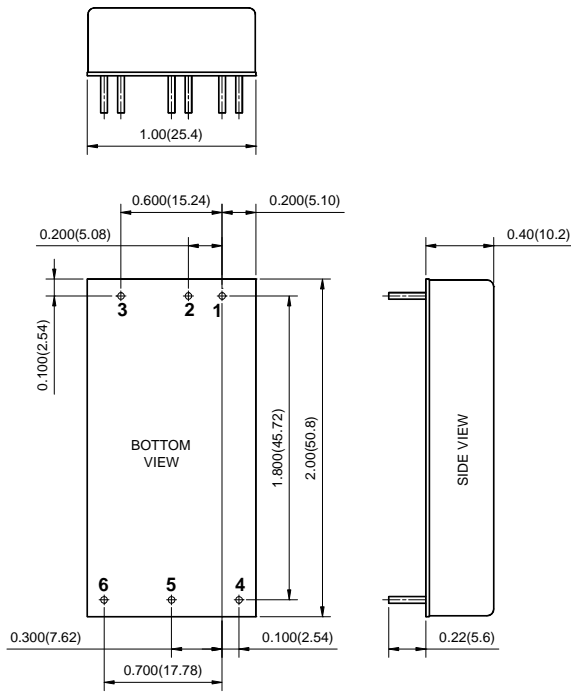

PIN CONNECTION	
PIN	FUNCTION
1	+ INPUT
2	- INPUT
3	CTRL
4	+OUTPUT
5	- OUTPUT
6	TRIM

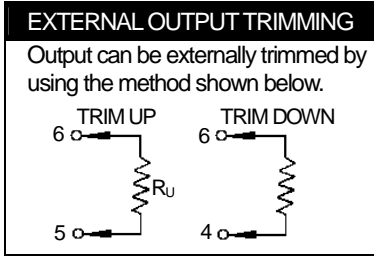

- All dimensions in Inches (mm)  
 Tolerance: X.XX±0.02 (X.X±0.5)  
 X.XXX±0.01 (X.XX±0.25)
- Pin pitch tolerance ±0.01 (0.25)
- Pin dimension tolerance ±0.004 (0.1)

Recommended Pad Layout

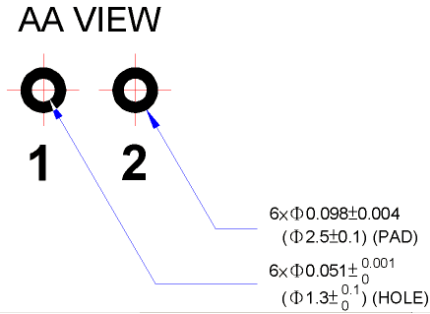
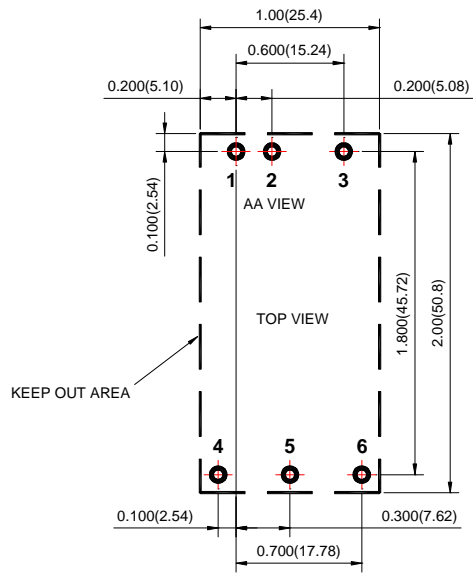

1. All dimensions in Inches (mm)  
Tolerance: X.XX±0.02 (X.X±0.5)  
X.XXX±0.01 (X.XX±0.25)
2. Pin pitch tolerance ±0.01(0.25)
3. Pin dimension tolerance ±0.004 (0.1)

Soldering and Reflow Considerations

Lead free wave solder profile for PXE30-xxWSxx series.

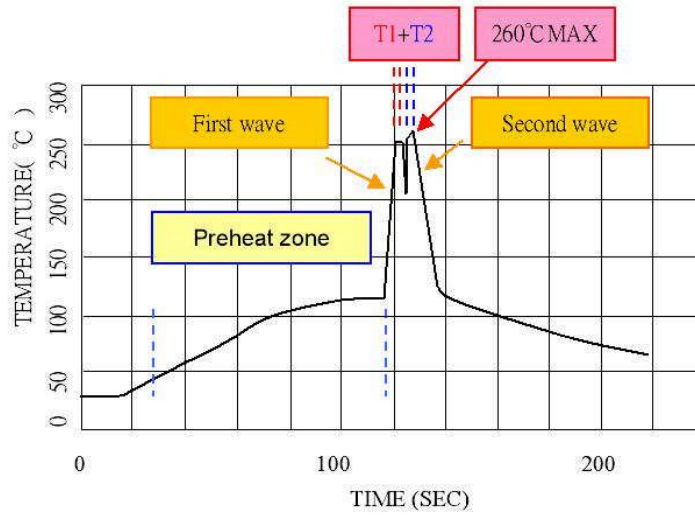

Zone	Reference Parameter
Preheat zone	Rise temp. speed : 3°C □/ sec max. Preheat temp. : 100~130°C
Actual heating	Peak temp. : 250~260°C Peak time (T1+T2 time) : 4~6 sec

**Reference Solder:** Sn-Ag-Cu / : Sn-Cu

**Hand Welding:** Soldering iron - Power 90W

Welding Time: : 2-4 sec

Temp. : 380-400°C °C

Packaging Information

TUBE

20 PCS per TUBE

TRAY

20 PCS per TRAY

**Part Number Structure**

**PXD 30 - 24 WS 05 -N**

**Max. Output Power**  
30Watts

**Input Voltage Range**  
24 : 9 ~ 36V  
48 : 18 ~ 75V

**4 : 1 Wide Input**

**Single Output**

**Remote ON/OFF Options**  
No Suffix = Positive Logic  
Suffix -N = Negative Logic

**Output Voltage**  
1P5 : 1.5Vdc  
2P5 : 2.5Vdc  
3P3 : 3.3Vdc  
05 : 5Vdc  
5P1 : 5.1Vdc  
12 : 12Vdc  
15 : 15Vdc

Model Number	Input Range	Output Voltage	Output Current	Input Current	Eff <sup>(2)</sup> (%)
			Max. Load	Full Load <sup>(1)</sup>	
PXD30-24WS1P5	18 - 36 VDC	1.5 VDC	8500mA	700	80
PXD30-24WS2P5	18 - 36 VDC	2.5 VDC	8000mA	1054	83
PXD30-24WS3P3	18 - 36 VDC	3.3 VDC	7500mA	1258	86
PXD30-24WS05	18 - 36 VDC	5 VDC	6000mA	1488	88
PXD30-24WS5P1	18 - 36 VDC	5.1VDC	6000mA	1517	88
PXD30-24WS12	18 - 36 VDC	12 VDC	2500mA	1471	89
PXD30-24WS15	18 - 36 VDC	15 VDC	2000mA	1471	89
PXD30-48WS1P5	36 - 75 VDC	1.5 VDC	8500mA	350	80
PXD30-48WS2P5	36 - 75 VDC	2.5 VDC	8000mA	520	84
PXD30-48WS3P3	36 - 75 VDC	3.3 VDC	7500mA	629	86
PXD30-48WS05	36 - 75 VDC	5 VDC	6000mA	744	88
PXD30-48WS5P1	36 - 75 VDC	5.1VDC	6000mA	759	88
PXD30-48WS12	36 - 75 VDC	12 VDC	2500mA	727	90
PXD30-48WS15	36 - 75 VDC	15 VDC	2000mA	718	91

Note 1. Maximum value at nominal input voltage and full load.  
 Note 2. Typical value at nominal input voltage and full load.

**Safety and Installation Instruction**

**Fusing Consideration**

Caution: This converter is not internally fused. An input line fuse must always be used.

This encapsulated converter can be used in a wide variety of applications, ranging from simple stand-alone operation to an integrated part of a sophisticated power architecture. For maximum flexibility, internal fusing is not included; however, to achieve maximum safety and system protection, always use an input line fuse. The safety agencies require a slow-blow fuse with maximum rating of 10A based on the information provided in this data sheet on inrush energy and maximum dc input current; the same type of fuse with lower rating can be used. Refer to the fuse manufacturer's data for further information.

**MTBF and Reliability**

**The MTBF of PXD30-xxWSxx DC/DC converters has been calculated using:**

Bellcore TR-NWT-000332 Case I: 50% stress, Operating Temperature at 40°C °C (Ground fixed and controlled environment ). The resulting figure for MTBF is 3.173x10<sup>6</sup> hours.

MIL-HDBK 217F NOTICE2 FULL LOAD, Operating Temperature at 25°C °C. The resulting figure for MTBF is 5.548x10<sup>5</sup> hours.