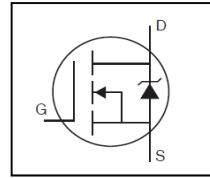


- Advanced Process Technology
- Isolated Package
- High Voltage Isolation = 2.5KVRMS ⑤
- Sink to Lead Creepage Dist. = 4.8mm
- Fully Avalanche Rated
- Lead-Free

HEXFET® Power MOSFET



<b>V<sub>DSS</sub></b>	<b>100V</b>
<b>R<sub>DS(on)</sub></b>	<b>0.036Ω</b>
<b>I<sub>D</sub></b>	<b>24A</b>



TO-220 Full-Pak

<b>G</b>	<b>D</b>	<b>S</b>
Gate	Drain	Source

**Description**

Fifth Generation HEXFETs from International Rectifier utilize advanced processing techniques to achieve extremely low on-resistance per silicon area. This benefit, combined with the fast switching speed and ruggedized device design that HEXFET Power MOSFETs are well known for, provides the designer with an extremely efficient and reliable device for use in a wide variety of applications

The TO-220 Fullpak eliminates the need for additional insulating hardware in commercial-industrial applications. The moulding compound used provides a high isolation capability and a low thermal resistance between the tab and external heatsink. This isolation is equivalent to using a 100 micron mica barrier with standard TO-220 product. The Fullpak is mounted to a heatsink using a single clip or by a single screw fixing.

Base Part Number	Package Type	Standard Pack		Orderable Part Number
		Form	Quantity	
IRFI1310NPbF	TO-220 Full-Pak	Tube	50	IRFI1310NPbF

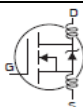
**Absolute Maximum Ratings**

Symbol	Parameter	Max.	Units
I <sub>D</sub> @ T <sub>C</sub> = 25°C	Continuous Drain Current, V <sub>GS</sub> @ 10V	24	A
I <sub>D</sub> @ T <sub>C</sub> = 100°C	Continuous Drain Current, V <sub>GS</sub> @ 10V	17	
I <sub>DM</sub>	Pulsed Drain Current ①⑥	140	
P <sub>D</sub> @ T <sub>C</sub> = 25°C	Maximum Power Dissipation	56	W
	Linear Derating Factor	0.37	W/°C
V <sub>GS</sub>	Gate-to-Source Voltage	± 20	V
E <sub>AS</sub>	Single Pulse Avalanche Energy (Thermally Limited) ②⑥	420	mJ
I <sub>AR</sub>	Avalanche Current ①⑥	22	A
E <sub>AR</sub>	Repetitive Avalanche Energy ①	5.6	mJ
dv/dt	Peak Diode Recovery dv/dt③⑥	5.0	V/ns
T <sub>J</sub>	Operating Junction and Storage Temperature Range	-55 to + 175	°C
T <sub>STG</sub>			
	Mounting torque, 6-32 or M3 screw	10 lbf•in (1.1N•m)	

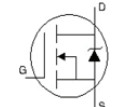
**Thermal Resistance**

Symbol	Parameter	Typ.	Max.	Units
R <sub>θJC</sub>	Junction-to-Case	—	2.7	°C/W
R <sub>θJA</sub>	Junction-to-Ambient	—	65	

**Electrical Characteristics @ T<sub>J</sub> = 25°C (unless otherwise specified)**

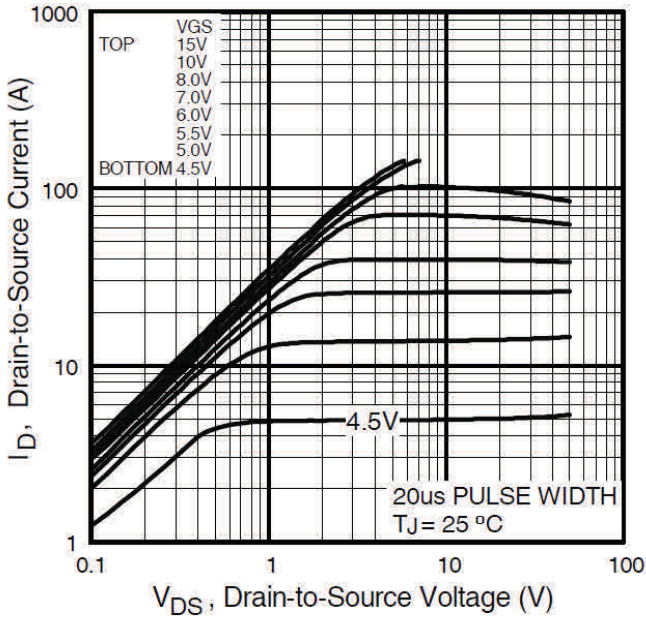
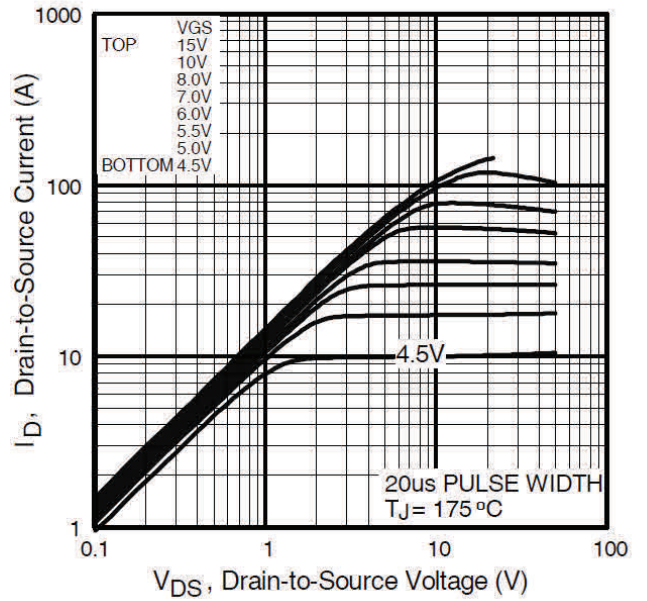
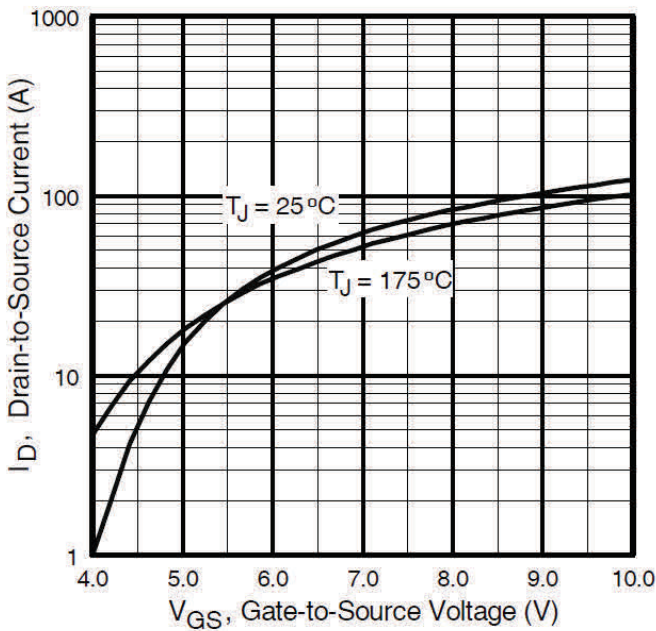
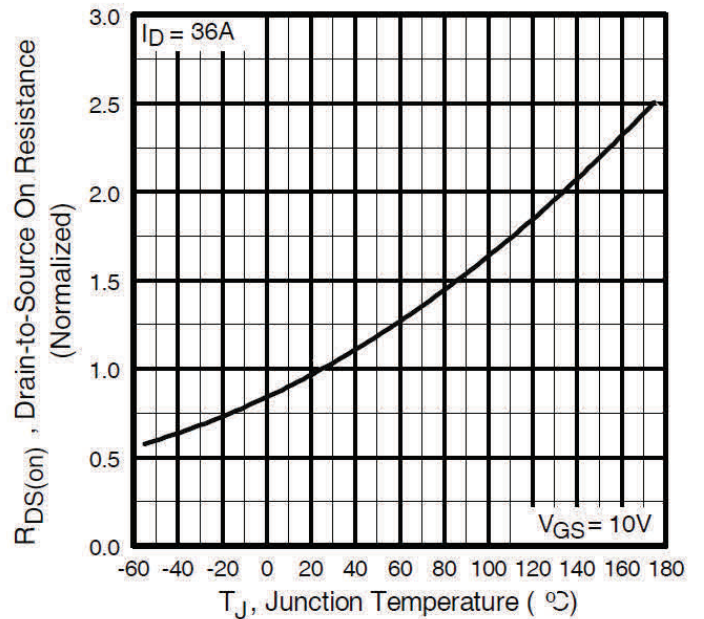
	Parameter	Min.	Typ.	Max.	Units	Conditions
V <sub>(BR)DSS</sub>	Drain-to-Source Breakdown Voltage	100	—	—	V	V <sub>GS</sub> = 0V, I <sub>D</sub> = 250μA
ΔV <sub>(BR)DSS/ΔT<sub>J</sub></sub>	Breakdown Voltage Temp. Coefficient	—	0.11	—	V/°C	Reference to 25°C, I <sub>D</sub> = 1mA ⑥
R <sub>DS(on)</sub>	Static Drain-to-Source On-Resistance	—	—	0.036	Ω	V <sub>GS</sub> = 10V, I <sub>D</sub> = 13A
V <sub>GS(th)</sub>	Gate Threshold Voltage	2.0	—	4.0	V	V <sub>DS</sub> = V <sub>GS</sub> , I <sub>D</sub> = 250μA
g <sub>fs</sub>	Forward Trans conductance	14	—	—	S	V <sub>DS</sub> = 25V, I <sub>D</sub> = 22A⑥
I <sub>DSS</sub>	Drain-to-Source Leakage Current	—	—	25	μA	V <sub>DS</sub> = 100 V, V <sub>GS</sub> = 0V
		—	—	250		V <sub>DS</sub> = 80V, V <sub>GS</sub> = 0V, T <sub>J</sub> = 150°C
I <sub>GSS</sub>	Gate-to-Source Forward Leakage	—	—	100	nA	V <sub>GS</sub> = 20V
	Gate-to-Source Reverse Leakage	—	—	-100		V <sub>GS</sub> = -20V
Q <sub>g</sub>	Total Gate Charge	—	—	120	nC	I <sub>D</sub> = 22A
Q <sub>gs</sub>	Gate-to-Source Charge	—	—	15		V <sub>DS</sub> = 80V
Q <sub>gd</sub>	Gate-to-Drain Charge	—	—	58		V <sub>GS</sub> = 10V, See Fig. 6 and 13④⑥
t <sub>d(on)</sub>	Turn-On Delay Time	—	11	—	ns	V <sub>DD</sub> = 50V
t <sub>r</sub>	Rise Time	—	56	—		I <sub>D</sub> = 22A
t <sub>d(off)</sub>	Turn-Off Delay Time	—	45	—		R <sub>G</sub> = 3.6Ω
t <sub>f</sub>	Fall Time	—	40	—		R <sub>D</sub> = 2.9Ω, See Fig. 10④⑥
L <sub>D</sub>	Internal Drain Inductance	—	4.5	—	nH	Between lead, 6mm (0.25in.) from package and center of die contact
L <sub>S</sub>	Internal Source Inductance	—	7.5	—		
C <sub>iss</sub>	Input Capacitance	—	1900	—	pF	V <sub>GS</sub> = 0V
C <sub>oss</sub>	Output Capacitance	—	450	—		V <sub>DS</sub> = 25V
C <sub>rss</sub>	Reverse Transfer Capacitance	—	230	—		f = 1.0MHz, See Fig. 5⑥
C	Drain to Sink Capacitance	—	12	—		f = 1.0MHz

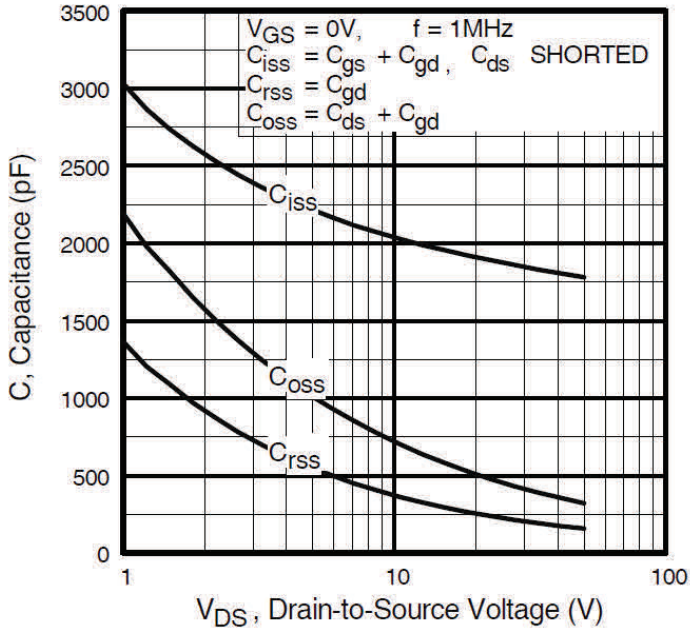
**Source-Drain Ratings and Characteristics**

	Parameter	Min.	Typ.	Max.	Units	Conditions
I <sub>S</sub>	Continuous Source Current (Body Diode)	—	—	24	A	MOSFET symbol showing the integral reverse p-n junction diode. 
I <sub>SM</sub>	Pulsed Source Current (Body Diode) ①	—	—	140		
V <sub>SD</sub>	Diode Forward Voltage	—	—	1.3	V	T <sub>J</sub> = 25°C, I <sub>S</sub> = 13A, V <sub>GS</sub> = 0V ④
t <sub>rr</sub>	Reverse Recovery Time	—	180	270	ns	T <sub>J</sub> = 25°C, I <sub>F</sub> = 22A
Q <sub>rr</sub>	Reverse Recovery Charge	—	1.2	1.8	μC	di/dt = 100A/μs ④⑥
t <sub>on</sub>	Forward Turn-On Time	Intrinsic turn-on time is negligible (turn-on is dominated by L <sub>S</sub> +L <sub>D</sub> )				

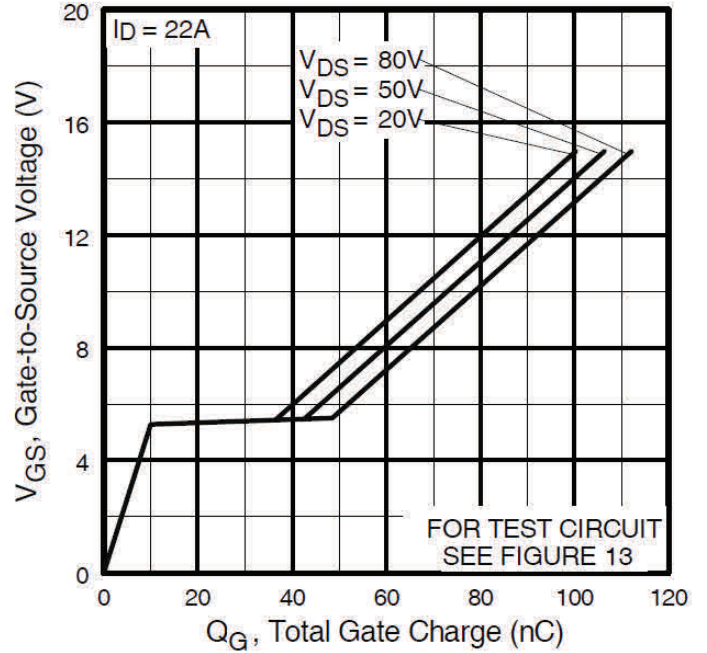
**Notes:**

- ① Repetitive rating; pulse width limited by max. junction temperature. (See fig. 11)
- ② starting T<sub>J</sub> = 25°C, L = 1.0mH, R<sub>G</sub> = 25Ω, I<sub>AS</sub> = 22A (See fig. 12)
- ③ I<sub>SD</sub> ≤ 22A, di/dt ≤ 180A/μs, V<sub>DD</sub> ≤ V<sub>(BR)DSS</sub>, T<sub>J</sub> ≤ 175°C.
- ④ Pulse width ≤ 300μs; duty cycle ≤ 2%.
- ⑤ t=60s, f=60Hz
- ⑥ Uses IRF1310N data and test conditions.

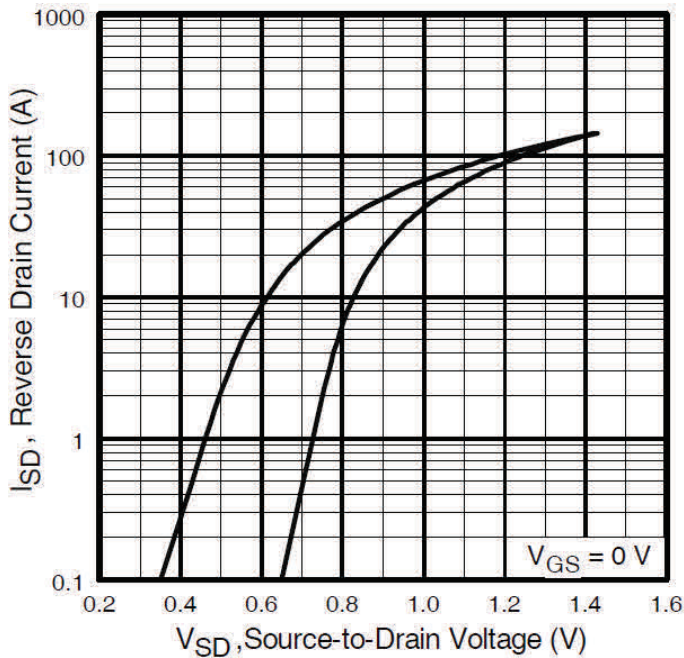

**Fig. 1** Typical Output Characteristics

**Fig. 2** Typical Output Characteristics

**Fig. 3** Typical Transfer Characteristics

**Fig. 4** Normalized On-Resistance vs. Temperature



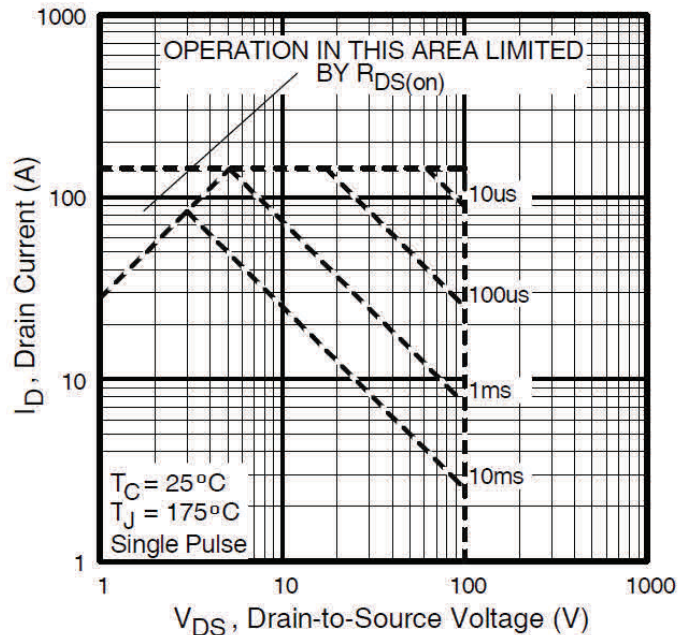
**Fig 5.** Typical Capacitance vs. Drain-to-Source Voltage



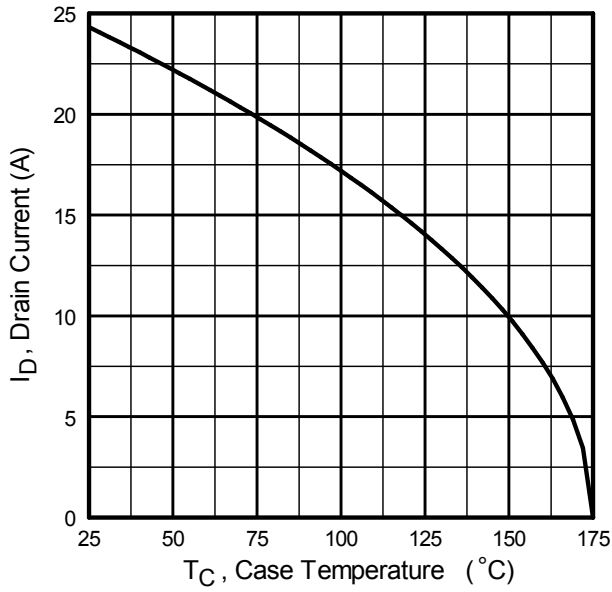
**Fig 6.** Typical Gate Charge vs. Gate-to-Source Voltage

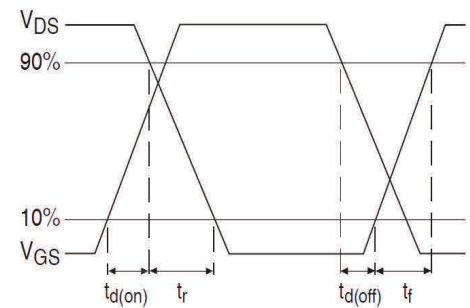
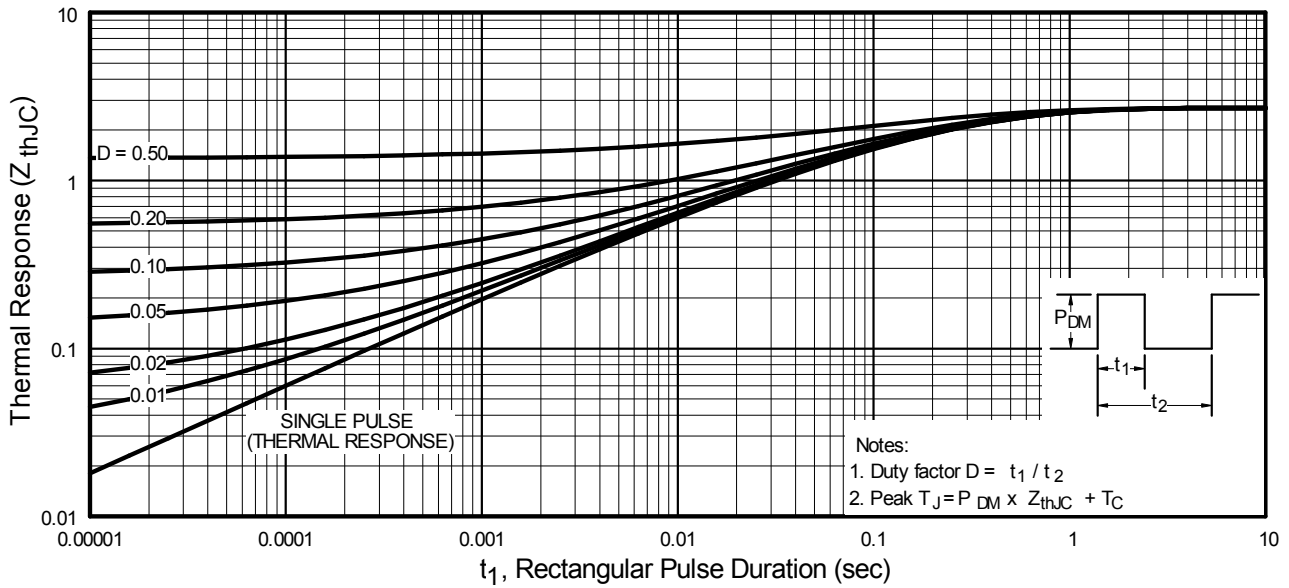


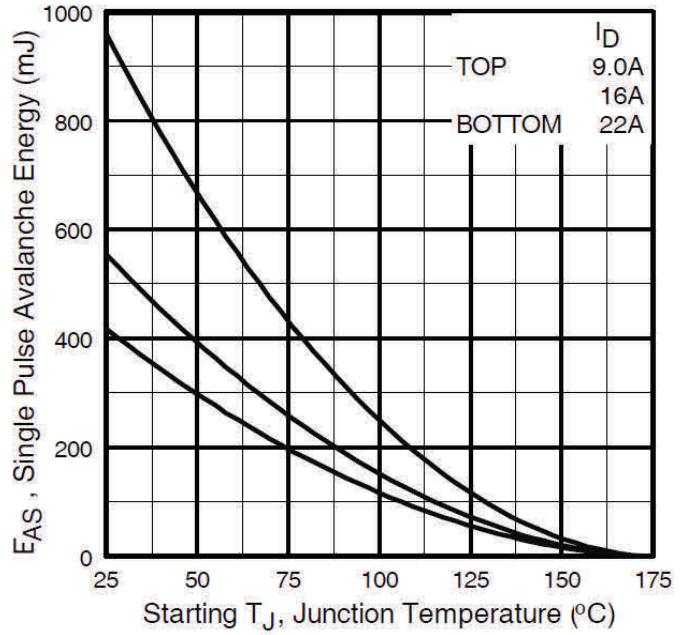
**Fig. 7** Typical Source-to-Drain Diode Forward Voltage

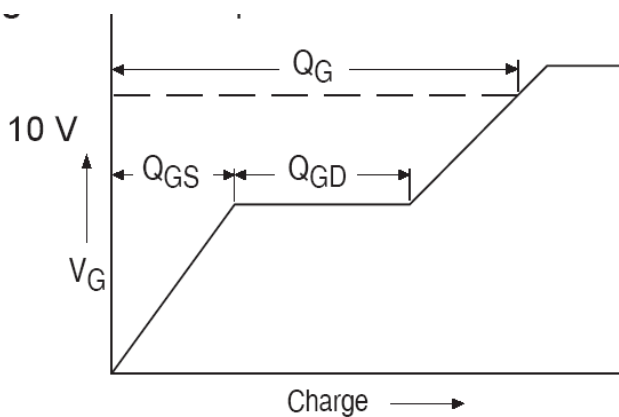
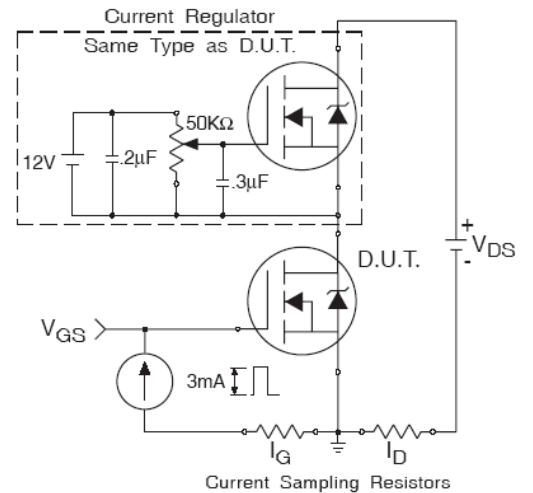


**Fig 8.** Maximum Safe Operating Area


**Fig 9.** Maximum Drain Current vs. Case Temperature

**Fig 10a.** Switching Time Test Circuit

**Fig 10b.** Switching Time Waveforms

**Fig 11.** Maximum Effective Transient Thermal Impedance, Junction-to-Case

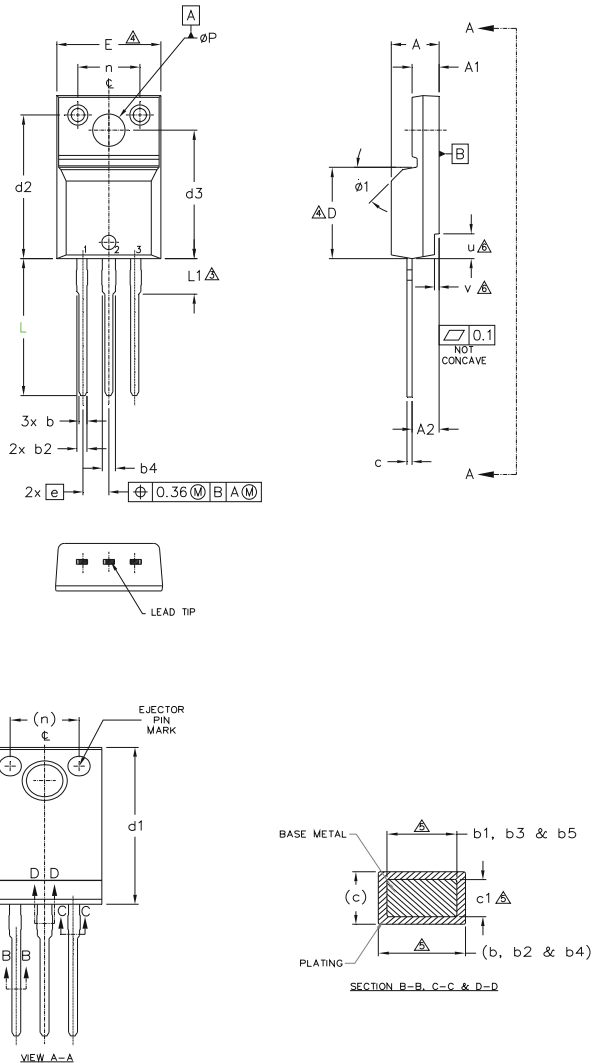

**Fig 12a. Unclamped Inductive Test Circuit**

**Fig 12c. Maximum Avalanche Energy vs. Drain Current**

**Fig 12b. Unclamped Inductive Waveforms**

**Fig 13a. Gate Charge Waveform**

**Fig 13b. Gate Charge Test Circuit**

### Peak Diode Recovery dv/dt Test Circuit



**Fig 14.** Peak Diode Recovery  $dv/dt$  Test Circuit for N-Channel HEXFET® Power MOSFETs

**TO-220 Full-Pak Package Outline (Dimensions are shown in millimeters (inches))**

**NOTES:**

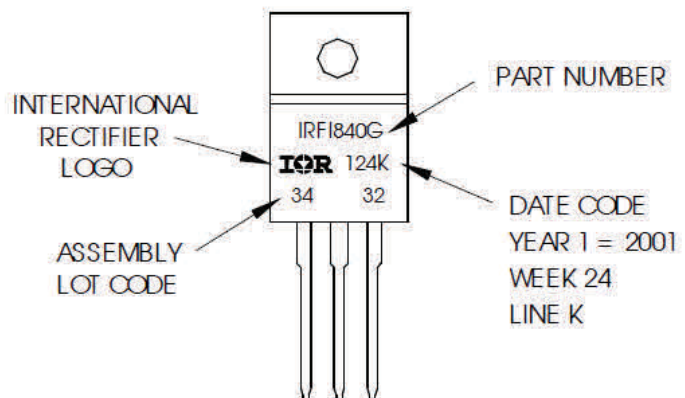
- 1.0 DIMENSIONING AND TOLERANCING AS PER ASME Y14.5 M- 1994.
- 2.0 DIMENSIONS ARE SHOWN IN MILLIMETERS [INCHES].
- 3.0 LEAD DIMENSION AND FINISH UNCONTROLLED IN L1.
- 4.0 DIMENSION D & E DO NOT INCLUDE MOLD FLASH. MOLD FLASH SHALL NOT EXCEED .005" (0.127) PER SIDE. THESE DIMENSIONS ARE MEASURED AT THE OUTER MOST EXTREMES OF THE PLASTIC BODY.
- 5.0 DIMENSION b1, b3, b5 & c1 APPLY TO BASE METAL ONLY.
- 6.0 STEP OPTIONAL ON PLASTIC BODY DEFINED BY DIMENSIONS u & v.
- 7.0 CONTROLLING DIMENSION : INCHES.

SYMBOL	DIMENSIONS				NOTES
	MILLIMETERS		INCHES		
	MIN.	MAX.	MIN.	MAX.	
A	4.57	4.83	.180	.190	LEAD ASSIGNMENTS  HEXFET 1.- GATE 2.- DRAIN 3.- SOURCE
A1	2.57	2.82	.101	.111	
A2	2.51	2.92	.099	.115	
b	0.61	0.94	.024	.037	
b1	0.61	0.89	.024	.035	
b2	0.76	1.27	.030	.050	
b3	0.76	1.22	.030	.048	
b4	1.02	1.52	.040	.060	
b5	1.02	1.47	.040	.058	
c	0.33	0.63	.013	.025	
c1	0.33	0.58	.013	.023	
D	8.66	9.80	.341	.386	
d1	15.80	16.13	.622	.635	
d2	13.97	14.22	.550	.560	
d3	12.29	12.93	.484	.509	
E	9.63	10.74	.379	.423	3
e	2.54 BSC		.100 BSC		
L	13.21	13.72	.520	.540	3
L1	3.10	3.68	.122	.145	
n	6.05	6.60	.238	.260	6
phi P	3.05	3.45	.120	.136	
u	2.39	2.49	.094	.098	6
v	0.41	0.51	.016	.020	
phi 1	-	45°	-	45°	

**TO-220 Full-Pak Part Marking Information**

EXAMPLE: THIS IS AN IRFI840G  
WITH ASSEMBLY  
LOT CODE 3432  
ASSEMBLED ON WW24, 2001  
IN THE ASSEMBLY LINE "K"

Note: "P" in assembly line position  
indicates "Lead-Free"



TO-220AB Full-Pak packages are not recommended for Surface Mount Application.

Note: For the most current drawing please refer to website at <http://www.irf.com/package/>



**Qualification Information**

<b>Qualification Level</b>	Industrial (per JEDEC JESD47F) †	
<b>Moisture Sensitivity Level</b>	TO-220 Full-Pak	N/A
<b>RoHS Compliant</b>	Yes	

† Applicable version of JEDEC standard at the time of product release.

**Revision History**

Date	Comments
5/27/2016	<ul style="list-style-type: none"> <li>Updated datasheet with corporate template.</li> <li>Added disclaimer on last page.</li> </ul>
04/27/2017	<ul style="list-style-type: none"> <li>Corrected Package Outline on page 8.</li> </ul>

**Trademarks of Infineon Technologies AG**

µHVIC™, µIPM™, µPFC™, AU-ConvertIR™, AURIX™, C166™, CanPAK™, CIPOS™, CIPURSE™, CoolDP™, CoolGaN™, COOLiR™, CoolMOST™, CoolSET™, CoolSiC™, DAVE™, DI-POL™, DirectFET™, DrBlade™, EasyPIM™, EconoBRIDGE™, EconoDUAL™, EconoPACK™, EconoPIM™, EiceDRIVER™, eupec™, FCOS™, GaNpowIR™, HEXFET™, HITFET™, HybridPACK™, iMOTION™, IRAM™, ISOFACE™, IsoPACK™, LEDrivIR™, LITIX™, MIPAQ™, ModSTACK™, my-d™, NovalithIC™, OPTIGA™, OptiMOST™, ORIGA™, PowIRaudio™, PowIRstage™, PrimePACK™, PrimeSTACK™, PROFET™, PRO-SiL™, RASiC™, REAL3™, SmartLEWIS™, SOLID FLASH™, SPOC™, StrongIRFET™, SupIRBuck™, TEMPFET™, TRENCHSTOP™, TriCore™, UHVIC™, XHP™, XMC™

Trademarks updated November 2015

**Other Trademarks**

All referenced product or service names and trademarks are the property of their respective owners.

**Edition 2016-04-19**

**Published by**

**Infineon Technologies AG  
81726 Munich, Germany**

**© 2016 Infineon Technologies AG.  
All Rights Reserved.**

**Do you have a question about this document?**

**Email:** [erratum@infineon.com](mailto:erratum@infineon.com)

**Document reference**

**ifx1**

**IMPORTANT NOTICE**

The information given in this document shall in no event be regarded as a guarantee of conditions or **characteristics ("Beschaffheitsgarantie")**.

With respect to any examples, hints or any typical values stated herein and/or any information regarding the application of the product, Infineon Technologies hereby disclaims any and all warranties and liabilities of any kind, including without limitation warranties of non-infringement of intellectual property rights of any third party.

In addition, any information given in this document **is subject to customer's compliance with its obligations** stated in this document and any applicable legal requirements, norms and standards concerning customer's products and any use of the product of Infineon Technologies in **customer's applications**.

The data contained in this document is exclusively intended for technically trained staff. It is the **responsibility of customer's technical departments** to evaluate the suitability of the product for the intended application and the completeness of the product information given in this document with respect to such application.

For further information on the product, technology, delivery terms and conditions and prices please contact your nearest Infineon Technologies office ([www.infineon.com](http://www.infineon.com)).

Please note that this product is not qualified according to the AEC Q100 or AEC Q101 documents of the Automotive Electronics Council.

**WARNINGS**

Due to technical requirements products may contain dangerous substances. For information on the types in question please contact your nearest Infineon Technologies office.

Except as otherwise explicitly approved by Infineon Technologies in a written document signed by authorized representatives of Infineon Technologies, **Infineon Technologies' products may not be used** in any applications where a failure of the product or any consequences of the use thereof can reasonably be expected to result in personal injury.

# Mouser Electronics

Authorized Distributor

Click to View Pricing, Inventory, Delivery & Lifecycle Information:

[Infineon:](#)

[IRF11310NPBF](#)