

LOC		DIST		REVISIONS			
P	LTR	DESCRIPTION	DATE	DMN	APVD		
E1		REVISED PER ECO-11-004587	11MAR11	RK	HMR		

- INSULATION RANGE: 1.09-2.79 [.043-.110]
WIRE RANGE: 0.2-0.9 mm (24-18) AWG.
- 0.00203 [.000080] MIN BRIGHT TIN-LEAD OVER 0.00127 [.000050] MIN NICKEL.
- 0.00076 [.000030] MIN THICK GOLD STRIPES IN LOCALIZED PLATE AREA ON BEAM AND DIMPLE OVER 0.00127 [.000050] MIN THICK NICKEL OVER ENTIRE CONTACT.
- DIMENSIONS IN BRACKETS ARE IN INCHES.
- 0.00203 [.000080] MIN BRIGHT TIN OVER 0.00127 [.000050] MIN NICKEL.

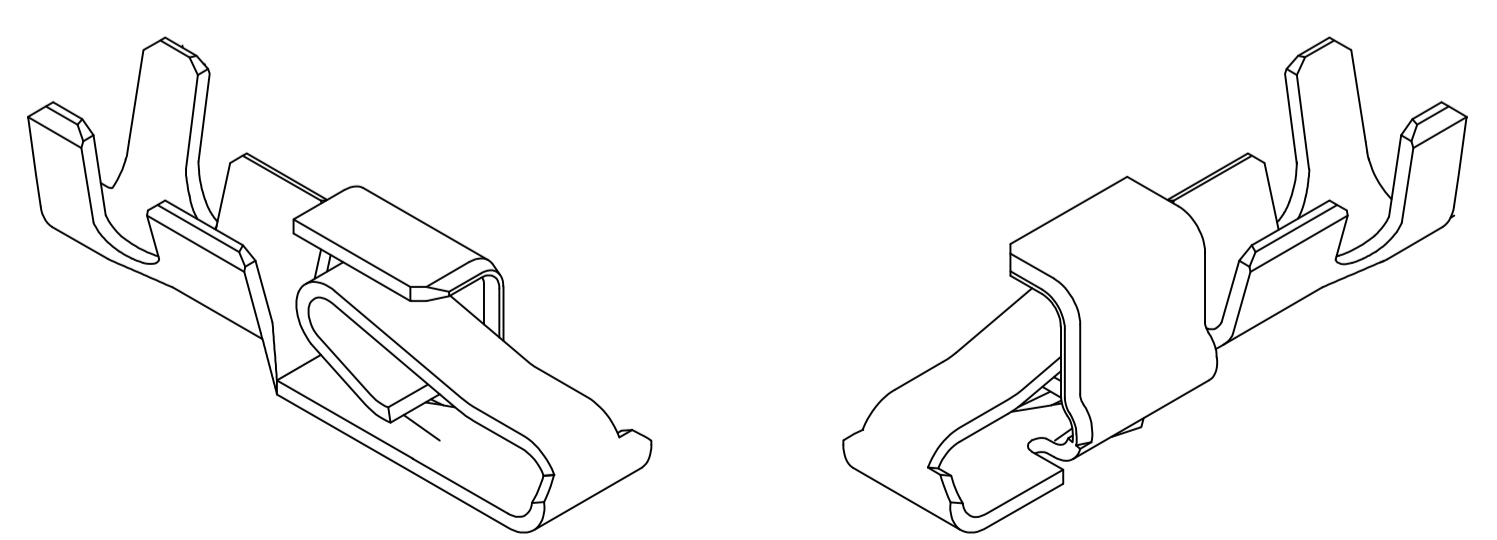
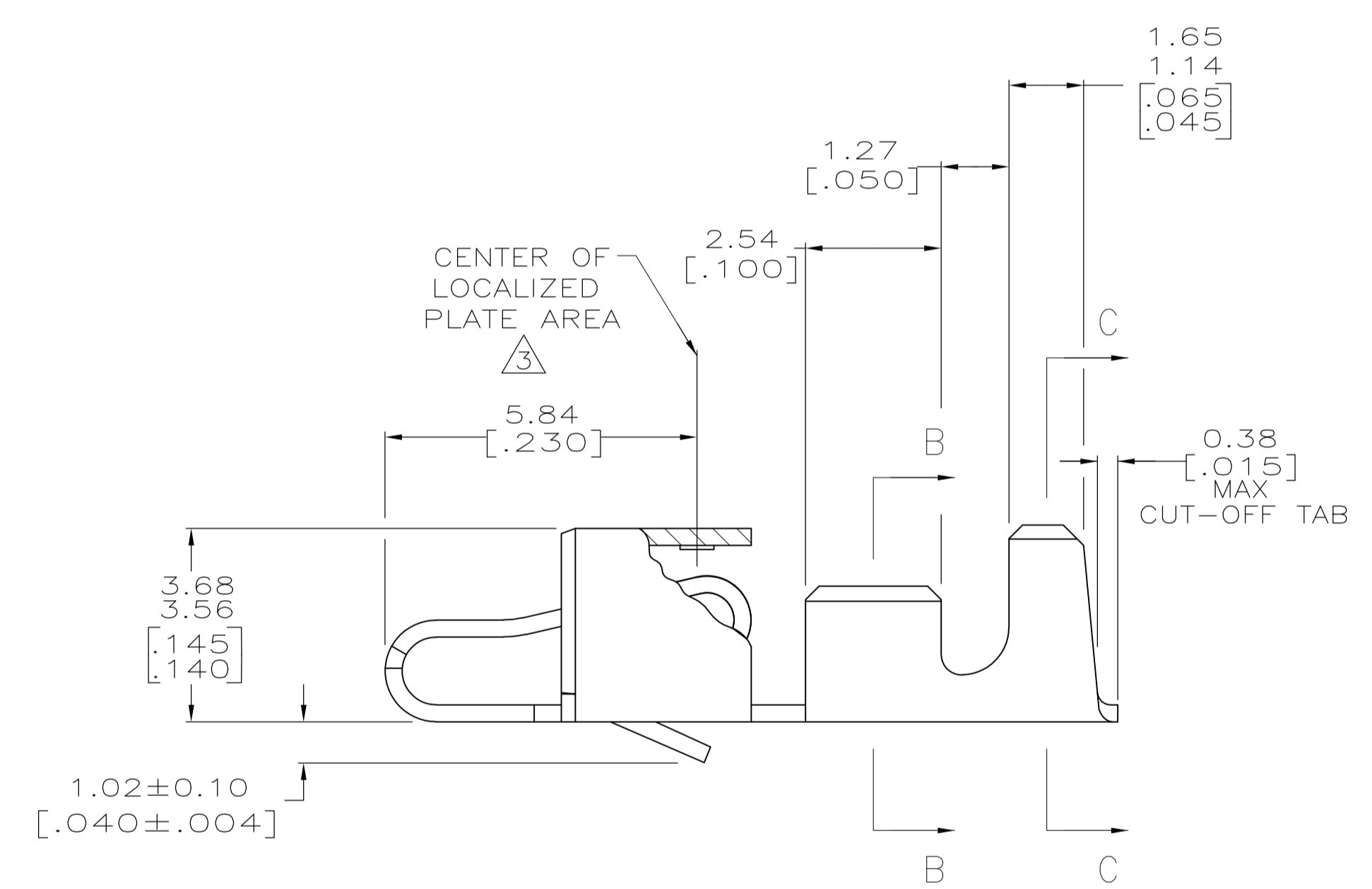
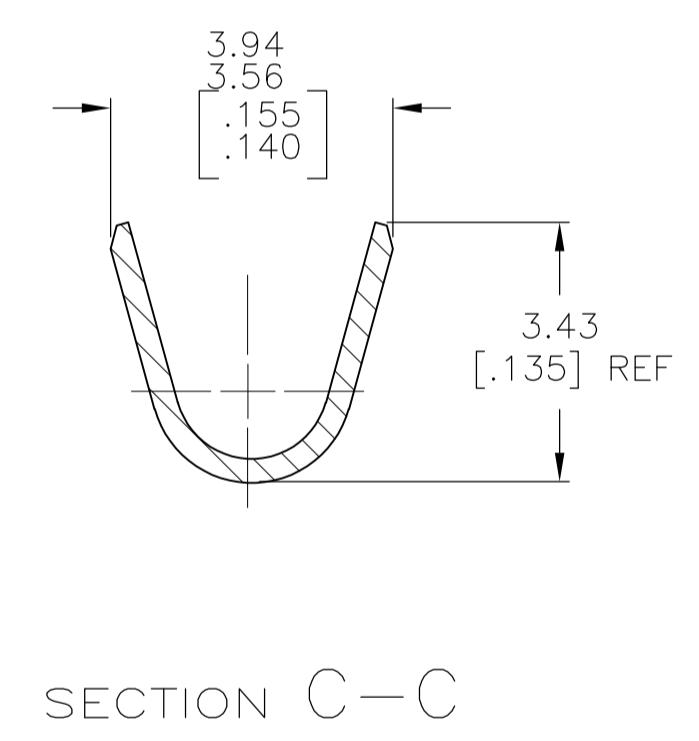
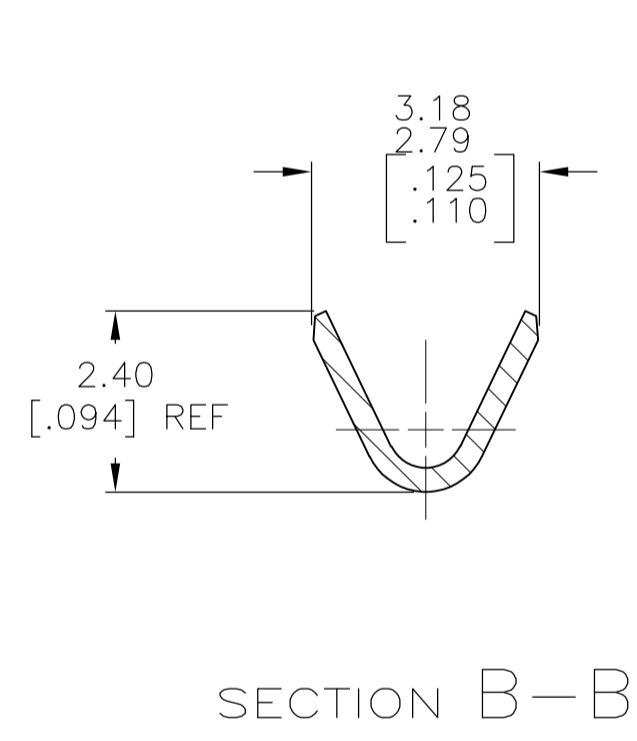
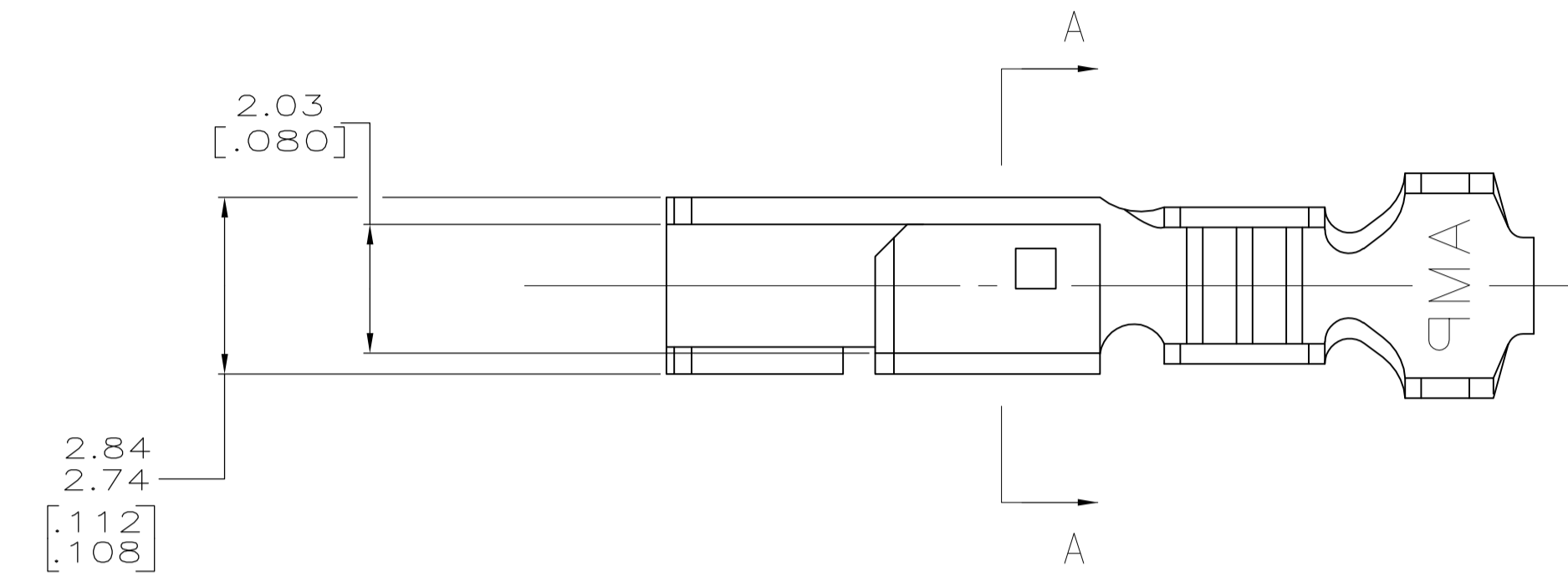
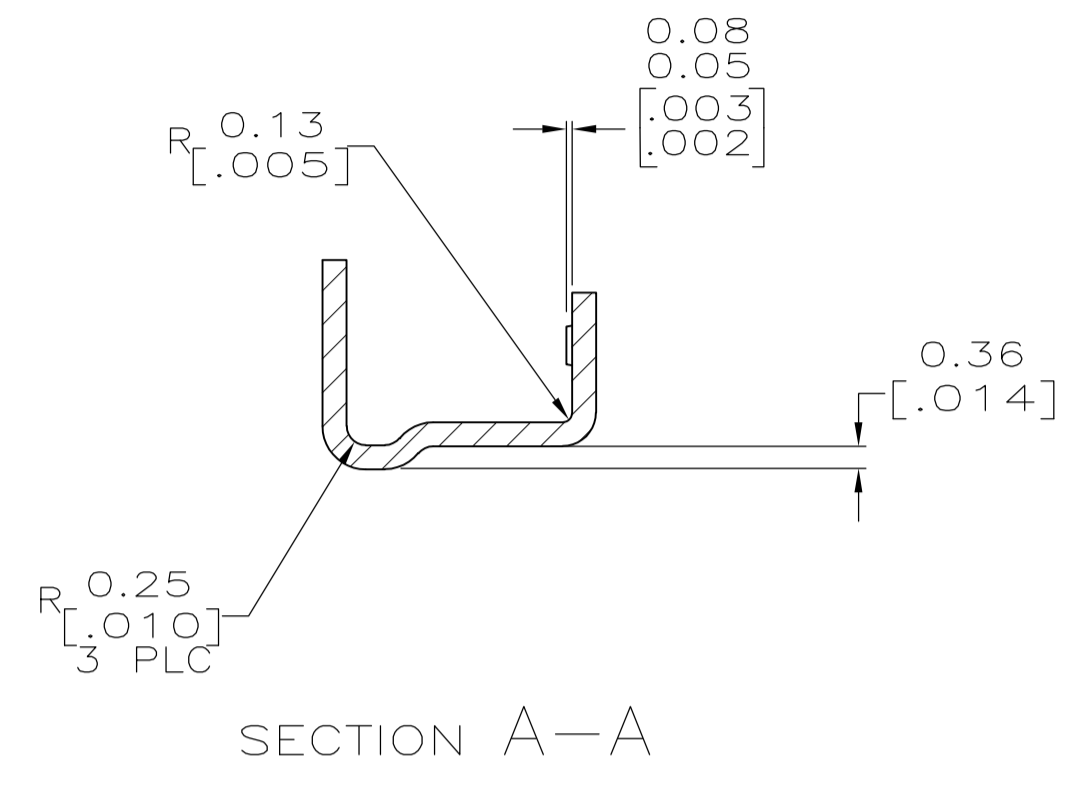

METRIC

△	3-770522-1
△	770522-2
△	770522-1
FINISH	PART NUMBER

THIS DRAWING IS A CONTROLLED DOCUMENT.		DIN K. WHITAKER 17MAY3006		STE TE Connectivity	
DIMENSIONS: mm [INCHES]		CHK J. ELLIS 17MAY2006		NAME	
TOLERANCES UNLESS OTHERWISE SPECIFIED:		APVD J. ELLIS 17MAY2006		RECEPTACLE, SL-156, LOOSE PIECE	
0 PLC ± -	1 PLC ± -	PRODUCT SPEC		SIZE CAGE CODE DRAWING NO	
2 PLC ± -	3 PLC ± 0.13 [.005]	APPLICATION SPEC		RESTRICTED TO	
4 PLC ± -	ANGLES ± -	WEIGHT		A1 00779C=770522	
MATERIAL .318 [.0125] PH BRZ		FINISH		CUSTOMER DRAWING	
		SCALE 10:1		SHEET 1 OF 1 REV E1	

Mouser Electronics

Authorized Distributor

Click to View Pricing, Inventory, Delivery & Lifecycle Information:

[TE Connectivity:](#)

[770522-1](#)