

DATE	REV	ECN	APP'D. BY
1-8-15	B5	10175	TRM
3-1-16	B6	10580	TRM

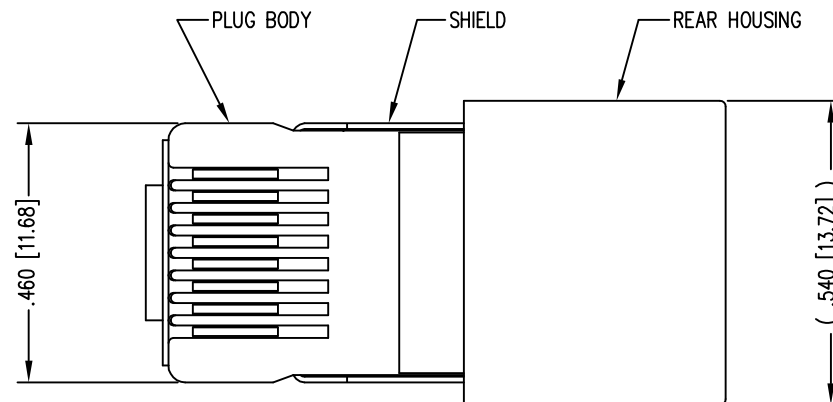

( SHOWN ASSEMBLED )

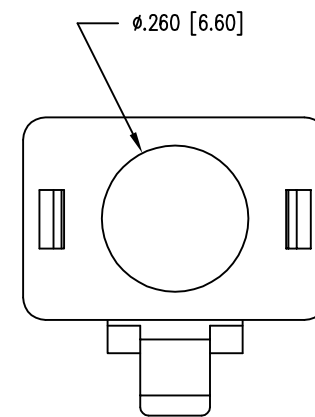
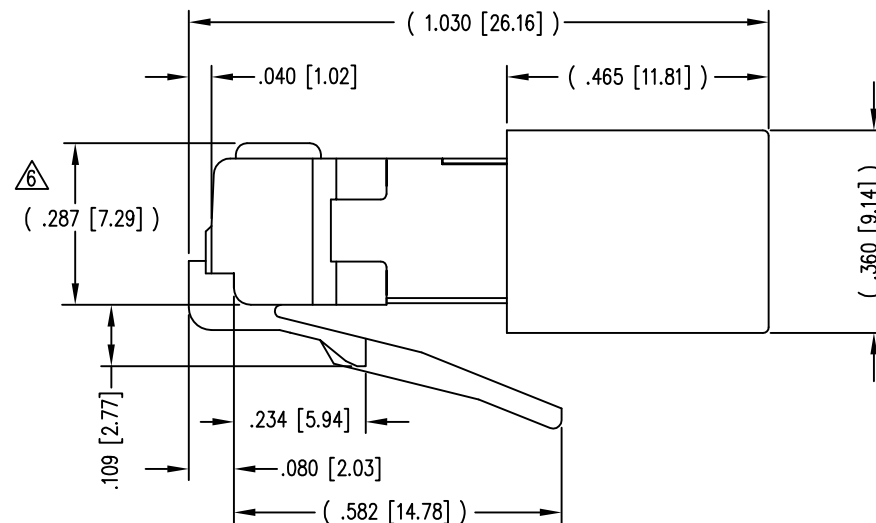
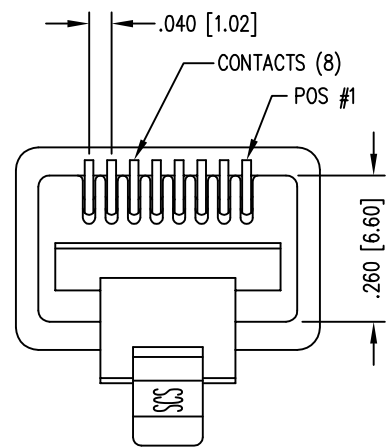

NOTES:

- 1- PLUG KIT CONSISTS OF :  
PRE-INSERTED PLUG HOUSING & SHIELD  
MANAGEMENT BAR  
FERRULE
- 2- MATERIALS :  
FRONT HOUSING PLASTIC : CLEAR POLYCARBONATE, UL 94-V0  
MANAGEMENT BAR : CLEAR POLYCARBONATE, UL 94-V0  
SHIELD : TIN PLATED BRASS  
CONTACTS : PHOSPHOR BRONZE, SELECTIVE GOLD PLATING  
FERRULE : NICKEL OR TIN PLATED BRASS
- 3- CONTACTS TERMINATE STRANDED & SOLID CONDUCTORS UP TO .042 [1.07] OUTSIDE DIAMETER OF INSULATION.
- 4- FOR PRODUCT SPECIFICATION SEE PR026-01.
- 5- DIMENSIONS AND TOLERANCES COMPLY WITH TIA-1096 STANDARD.
- 6- TERMINATED PLUG HEIGHT: .237 [6.02] ±.005 [0.13] ON CABLE
- 7- DESIGNED FOR CATEGORY 5/5e APPLICATIONS.

BULK	50 MICRO-INCHES [1.27um]	943-SP-370808SM2-A380
PACKAGE	CONTACT PLATING IN MATING AREA	PART NUMBER

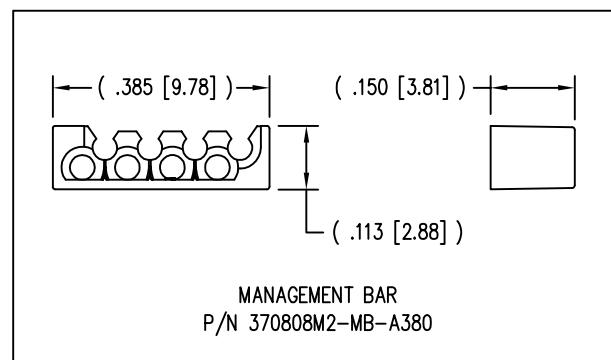
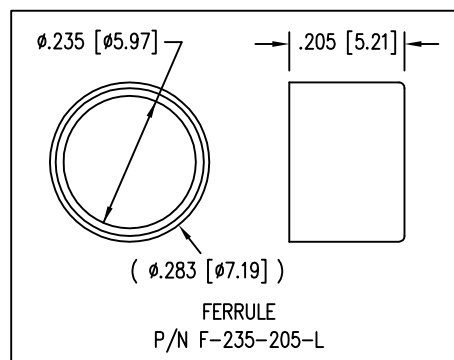

THIRD ANGLE PROJECTION

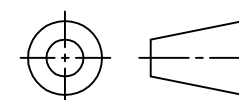

TITLE: SHIELDED CAT 5 PLUG 8 X 8

DO NOT SCALE DRAWING  
DRAWING IS SUBJECT TO  
CHANGE WITHOUT NOTICE

DIMENSIONS: INCHES [METRIC]  
UNLESS OTHERWISE SPECIFIED  
TOLERANCES ARE ±.005 [0.13]  
ANGLES ARE ± 1°

SHEET NO. 1 OF 1

THIS DRAWING AND THE SUBJECT MATTER SHOWN THEREON ARE CONFIDENTIAL AND THE PROPRIETARY PROPERTY OF STEWART CONNECTOR AND SHALL NOT BE REPRODUCED, COPIED, OR USED IN ANY MANNER WITHOUT PRIOR WRITTEN CONSENT OF STEWART CONNECTOR. ONE OR MORE U.S. PATENTS MAY APPLY TO THIS PRODUCT. FOR DETAILS, PLEASE VISIT: [HTTP://BELFUSE.COM/STEWART/STEWART\\_PATENTS/](http://BELFUSE.COM/STEWART/STEWART_PATENTS/)

DRN BY:	JAF	DATE	10-7-97
APPD BY:	RL	DATE	10-7-97
DWG NO.	CT370015	REV.	B6



# Mouser Electronics

Authorized Distributor

Click to View Pricing, Inventory, Delivery & Lifecycle Information:

Bel:

[943-SP-370808SM2-A380](#)