



# SERIES TL 1107 SWITCHES

## TACT SWITCHES - Rectangular



### SPECIFICATIONS

Rating:	50mA @ 12 VDC
Life Expectancy:	50,000 to 100,000 Depending on model
Contact Resistance:	100mΩ max., typical @ 2-4 VDC 100mA for both silver and gold plated contacts
Insulation Resistance:	100mΩ min.
Dielectric Strength:	250 VAC
Operating Force:	130 ± 50 gf, 180± 50 gf, 260 ± 50 gf
Operating Temperature:	-20°C to 70°C
Travel:	.025 Typ

### FEATURES & BENEFITS

- ▶ Reliable dome contact technology
- ▶ Strong tactile/audible feedback
- ▶ Multiple operating force options

### APPLICATIONS/MARKETS

- ▶ Telecommunications
- ▶ Consumer Electronics
- ▶ Audio/visual
- ▶ Medical
- ▶ Testing/instrumentation
- ▶ Computer/servers/peripherals



### HOW TO ORDER

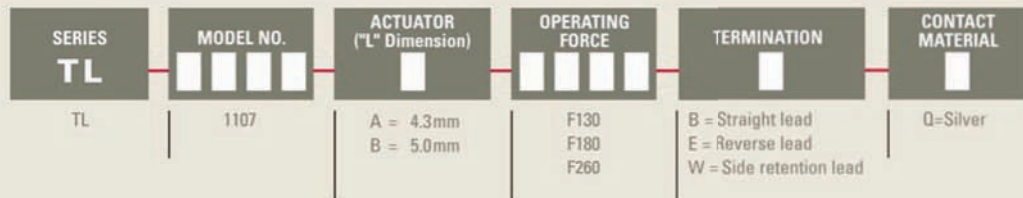

### Example Ordering Number

TL-1107-A-F130-W-Q

Specifications subject to change without notice.

## TL 1107

### B TERMINATION (STRAIGHT LEAD)

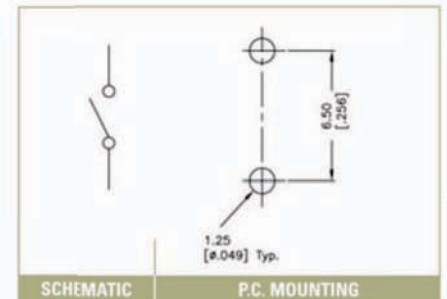
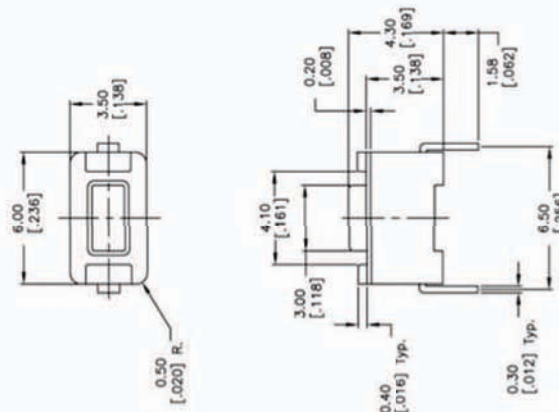

# SERIES TL 1107 SWITCHES

TACT SWITCHES - Rectangular

TACT SWITCHES

## TL 1107

E TERMINATION  
(REVERSE LEAD)

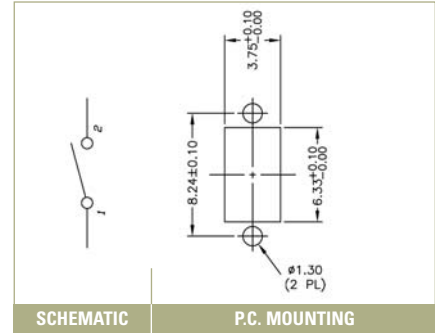
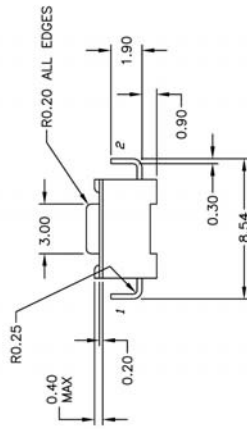
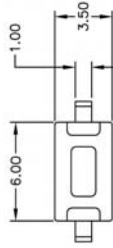

NAVIGATION SWITCHES

PUSHBUTTON SWITCHES

TOGGLE SWITCHES

ROCKER SWITCHES

## TL 1107

W TERMINATION  
(SIDE RETENTION LEAD)

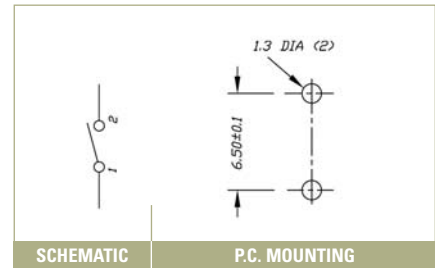
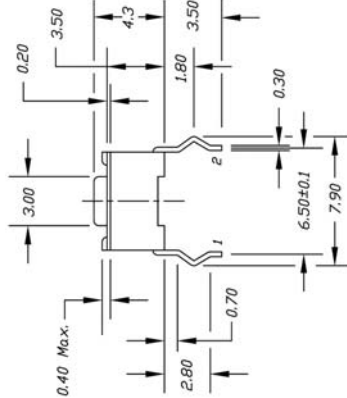
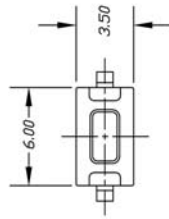

SLIDE SWITCHES

SNAP-ACTION SWITCHES

DIP SWITCHES

KEYLOCK SWITCHES

ROTARY SWITCHES

DETECTOR SWITCHES

CAP OPTIONS

# Mouser Electronics

Authorized Distributor

Click to View Pricing, Inventory, Delivery & Lifecycle Information:

## E-Switch:

[TL1107BF130WQ](#) [TL1107AF130WQ](#) [TL1107AF260WQ](#) [TL1107BF180WQ](#) [TL1107AF180WQ](#) [TL1107AF260EQ](#)  
[TL1107BF130BQ](#) [TL1107BF180BQ](#) [TL1107BF180EQ](#) [TL1107BF260BQ](#) [TL1107BF260EQ](#) [TL1107BF260WQ](#)  
[TL1107AF130EQ](#) [TL1107BF130EQ](#)