

# MAX8900A/MAX8900B/MAX8900C

## 1.2A Switch-Mode Li+ Chargers with $\pm 22V$ Input Rating and JEITA Battery Temperature Monitoring

### General Description

The MAX8900\_ is a high-frequency, switch-mode charger for a 1-cell lithium ion (Li+) or lithium polymer (Li-Poly) battery. It delivers up to 1.2A of current to the battery from 3.4V to 6.3V (MAX8900A/MAX8900C) or 3.4V to 8.7V (MAX8900B). The 3.25MHz switch-mode charger is ideally suited to small portable devices such as headsets and ultra-portable media players because it minimizes component size and heat.

Several features make the MAX8900\_ perfect for high-reliability systems. The MAX8900\_ is protected against input voltages as high as +22V and as low as -22V. Battery protection features include low voltage prequalification, charge fault timer, die temperature monitoring, and battery temperature monitoring. The battery temperature monitoring adjusts the charge current and termination voltage as described in the JEITA\* specification for safe use of secondary lithium-ion batteries.

Charge parameters are easily adjustable with external components. An external resistance adjusts the charge current from 50mA to 1200mA. Another external resistance adjusts the prequalification and done current thresholds from 10mA to 200mA. The done current threshold is very accurate achieving  $\pm 1mA$  at the 10mA level. The charge timer is adjustable with an external capacitor. The MAX8900\_ is available in a 0.4mm pitch, 2.44mm x 2.67mm x 0.64mm WLP package.

### Applications

USB Charging	Digital Cameras
Headsets and Media Players	GPS, PND
Smartphones	eBook

### Ordering Information (continued)

PART	TEMP RANGE	PIN-PACKAGE	OPTIONS
MAX8900AEWV+T	-40°C to +85°C	30 WLP	VOVLO = 6.5V T1 = 0°C 2-pin status indicators VPQUTH = 2.8V
MAX8900BEWV+T	-40°C to +85°C	30 WLP	VOVLO = 9.0V T1 = -15°C 3-pin status indicators VPQUTH = 2.8V

+Denotes a lead(Pb)-free/RoHS-compliant package.  
T = Tape and reel.

Ordering Information continued at end of data sheet.

For pricing, delivery, and ordering information, please contact Maxim Direct at 1-888-629-4642, or visit Maxim's website at [www.maximintegrated.com](http://www.maximintegrated.com).

19-5063; Rev 4; 11/14

### Features

- ◆ 3.25MHz Switching Li+/Li-Poly Battery Charger
- ◆ JEITA Battery Temperature Monitor Adjusts Charge Current and Termination Voltage
- ◆ 4.2V  $\pm 0.5\%$  Battery Regulation Voltage (Alternate 4.1V Target Available on Request)
- ◆ Adjustable Done Current Threshold  
Adjustable from 10mA to 200mA  
 $\pm 1mA$  Accuracy at 10mA
- ◆ High-Efficiency and Low Heat
- ◆ Uses a 2.0mm x 1.6mm Inductor
- ◆ Positive and Negative Input Voltage Protection ( $\pm 22V$ )
- ◆ Up to +20V Operating Range (Alternate OVLO Ranges Available on Request)
- ◆ Supports No-Battery Operation
- ◆ Fault Timer
- ◆ Charge Status Outputs
- ◆ 2.44mm x 2.67mm x 0.64mm Package

### Simplified Applications Circuit

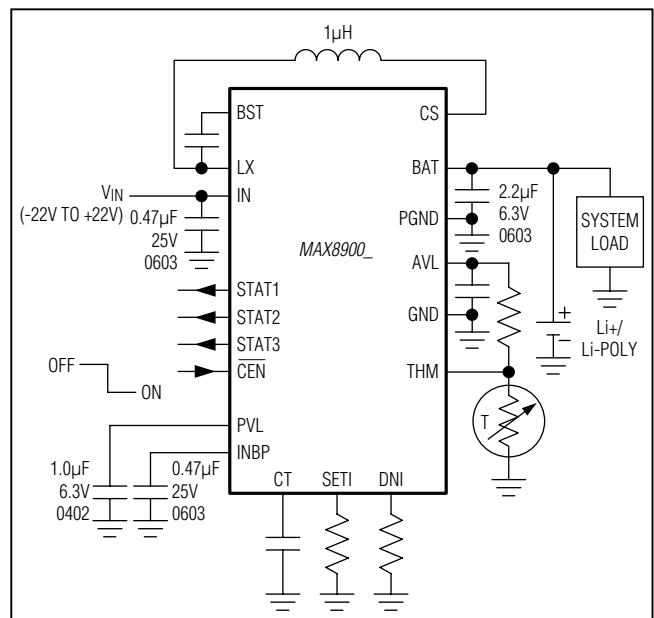

\*JEITA (Japan Electronics and Information Technology Industries Association) standard, "A Guide to the Safe Use of Secondary Lithium Ion Batteries in Notebook-type Personal Computers" April 20, 2007.

# MAX8900A/MAX8900B/MAX8900C

## 1.2A Switch-Mode Li+ Chargers with $\pm 22V$ Input Rating and JEITA Battery Temperature Monitoring

### TABLE OF CONTENTS

Absolute Maximum Ratings . . . . .	4
Electrical Characteristics . . . . .	4
Typical Operating Characteristics . . . . .	8
Pin Configuration . . . . .	13
Pin Description . . . . .	13
Detailed Description . . . . .	17
Control Scheme . . . . .	17
Soft-Start . . . . .	17
Setting the Fast-Charge Current (SETI) . . . . .	17
Setting the Prequalification Current and Done Threshold (DNI) . . . . .	18
Charge Enable Input ( $\overline{CEN}$ ) . . . . .	18
Charger States . . . . .	19
Charger Disabled State . . . . .	22
Dead-Battery State . . . . .	22
Dead Battery + Prequalification State . . . . .	22
Prequalification State . . . . .	22
Fast-Charge Constant Current State . . . . .	22
Fast-Charge Constant Voltage State . . . . .	22
Top-Off State . . . . .	22
Done State . . . . .	23
Timer Fault State . . . . .	23
Battery Hot/Cold State . . . . .	23
$V_{IN}$ Too High State . . . . .	23
Charge Timer (CT) . . . . .	23
Thermal Management . . . . .	23
Thermistor Monitor (THM) . . . . .	24
Thermal Foldback . . . . .	26
Thermal Shutdown . . . . .	26
PVL and AVL Regulator . . . . .	27
Charge Status Outputs (3 Pin) . . . . .	27
Charge Status Outputs (2 Pin + > T4) . . . . .	27
Inductor Selection . . . . .	28
BAT Capacitor . . . . .	29
INBP Capacitor . . . . .	29
Other Capacitors . . . . .	29
Applications Information . . . . .	30
Dynamic Charge Current Programming . . . . .	30
No-Battery Operation . . . . .	30

# MAX8900A/MAX8900B/MAX8900C

## 1.2A Switch-Mode Li+ Chargers with $\pm 22V$ Input Rating and JEITA Battery Temperature Monitoring

---

### TABLE OF CONTENTS (continued)

---

Charge-Source Issues . . . . .	30
Charge-Source Impedance . . . . .	30
Inductive Kick . . . . .	30
Overvoltage and Reverse Input Voltage Protection . . . . .	31
PCB Layout . . . . .	31
Chip Information . . . . .	33
Package Information . . . . .	34
Revision History . . . . .	35

---

### LIST OF FIGURES

---

Figure 1. Applications Circuit: Single SETI Resistor, Status Indicators Connected to LEDs . . . . .	15
Figure 2. Applications Circuit: Multiple Charge Rates Managed by $\mu P$ to Be USB Compliant, Status Indicators Connected to a $\mu P$ . . . . .	15
Figure 3. Functional Diagram . . . . .	16
Figure 4. Fast-Charge Current vs. $R_{SETI}$ ( <a href="http://www.maximintegrated.com/tools/other/software/MAX8900-RSETI.XLS">www.maximintegrated.com/tools/other/software/MAX8900-RSETI.XLS</a> ) . . . . .	18
Figure 5. Prequalification Current and Done Threshold vs. $R_{DNI}$ ( <a href="http://www.maximintegrated.com/tools/other/software/MAX8900-DNI.XLS">www.maximintegrated.com/tools/other/software/MAX8900-DNI.XLS</a> ) . . . . .	18
Figure 6. Li+/Li-Poly Charge Profile . . . . .	19
Figure 7. Charger State Diagram (3-Pin Status) . . . . .	20
Figure 8. Charger State Diagram (2-Pin Status) . . . . .	21
Figure 9. Charge Times vs. $C_{CT}$ . . . . .	23
Figure 10. JEITA Battery Safety Regions . . . . .	25
Figure 11. Thermistor Monitor Detail . . . . .	26
Figure 12. Charge Current vs. Junction Temperature . . . . .	26
Figure 13. Calculated Fast-Charge Current vs. Dropout Voltage . . . . .	29
Figure 14. Power PCB Layout Example . . . . .	32
Figure 15. Recommended Land Pattern . . . . .	33
Figure 16. Bump Cross Section and Copper Pillar Detail . . . . .	33

---

### LIST OF TABLES

---

Table 1. 2.44mm x 2.67mm x 0.64mm, 0.4mm Pitch WLP Thermal Characteristics . . . . .	24
Table 2. Trip Temperatures for Different Thermistors . . . . .	25
Table 3. 3-Pin Status Output Truth Table . . . . .	27
Table 4. 2-Pin Status Output Truth Table . . . . .	27
Table 5. Recommended Inductor Selection . . . . .	28
Table 6. Recommended Inductor . . . . .	28

# MAX8900A/MAX8900B/MAX8900C

## 1.2A Switch-Mode Li+ Chargers with ±22V Input Rating and JEITA Battery Temperature Monitoring

### ABSOLUTE MAXIMUM RATINGS

IN to PGND.....	-22V to +22V	PGND to GND.....	-0.3V to +0.3V
INBP to PGND.....	(VBAT - 0.3V) to +22V	IN Continuous Current.....	2.4ARMS
IN to INBP.....	-30V to +1.2V	LX Continuous Current (Note 1).....	1.6ARMS
STAT1, STAT2 to GND.....	-0.3V to +30V	CS Continuous Current.....	1.3ARMS
BST to PGND.....	-0.3V to +36V	BAT Continuous Current.....	1.3ARMS
BST to LX.....	-0.3V to +6.0V	Continuous Power Dissipation (TA = +70°C)	
BST to PVL.....	-0.3V to +30V	30-Bump WLP (derate 20.4mW/°C above +70°C)....	1616mW
PVL, BAT, CS to PGND.....	-0.3V to +6.0V	Operating Temperature Range.....	-40°C to +85°C
AVL, STAT3, CEN, THM to GND.....	-0.3V to +6.0V	Junction Temperature.....	-40°C to +150°C
PVL to AVL.....	-0.3V to +0.3V	Storage Temperature Range.....	-65°C to +150°C
CT to GND.....	-0.3V to (AVL + 0.3V)	Soldering Temperature (reflow).....	+260°C
SETI, DNI to GND.....	-0.3V to (VBAT + 0.3V)		

**Note 1:** LX has an internal clamp diode to PGND and INBP. Applications that forward bias these diodes should take care not to exceed the power dissipation limits of the device.

Stresses beyond those listed under "Absolute Maximum Ratings" may cause permanent damage to the device. These are stress ratings only, and functional operation of the device at these or any other conditions beyond those indicated in the operational sections of the specifications is not implied. Exposure to absolute maximum rating conditions for extended periods may affect device reliability.

### ELECTRICAL CHARACTERISTICS

(VIN = 6V, VBAT = 4V, RSETI = 2.87kΩ, RDNI = 3.57kΩ, VTHM = VAVL/2, circuit of Figure 1, TA = -40°C to +85°C, unless otherwise noted. Typical values are at TA = +25°C.) (Note 2)

PARAMETER	SYMBOL	CONDITIONS	MIN	TYP	MAX	UNITS	
<b>GENERAL</b>							
IN Input Voltage Range (Note 3)	VIN	Withstand voltage	-20		+20	V	
		Operating voltage	MAX8900B	3.4		8.7	V
MAX8900A/ MAX8900C	3.4			6.3			
IN Undervoltage Threshold	VUVLO	VIN falling, 400mV hysteresis (Note 4)	3.1	3.2	3.3	V	
IN to BAT Shutdown Threshold	VIN2BAT	When charging stops, VIN falling, 200mV hysteresis	0	15	30	mV	
IN Overvoltage Threshold (Note 3)	VOVLO	VIN rising	0.40V hysteresis (MAX8900B)	8.80	9.00	9.20	V
			0.26V hysteresis (MAX8900A/ MAX8900C)	6.35	6.50	6.65	
IN Supply Current	IIN	Charger enabled, no switching		1	2	mA	
		Charger enabled, f = 3.25MHz, VIN = 6V		20			
		Charger disabled, CEN = high		0.04	0.2		
LX High-Side Resistance	RHS			0.10		Ω	
LX Low-Side Resistance	RLS			0.15		Ω	
LX Leakage Current		LX = GND or IN	TA = +25°C	0.01	10	μA	
			TA = +85°C	0.1			
BST Leakage Current		VBST - VLX = 6V	TA = +25°C	0.01	10	μA	
			TA = +85°C	0.1			
Current-Sense Resistor	RSNS	VBAT = 2.6V		0.045		Ω	
IN to BAT Dropout Resistance	RIN2BAT	Calculation estimates a 40mΩ inductor resistance (RL), RIN2BAT = RIN2INBP + RHS + RL + RSNS		0.3		Ω	
Switching Frequency	fsw	VBAT = 2.6V		3.25		MHz	

# MAX8900A/MAX8900B/MAX8900C

## 1.2A Switch-Mode Li+ Chargers with ±22V Input Rating and JEITA Battery Temperature Monitoring

### ELECTRICAL CHARACTERISTICS (continued)

( $V_{IN} = 6V$ ,  $V_{BAT} = 4V$ ,  $R_{SET1} = 2.87k\Omega$ ,  $R_{DNI} = 3.57k\Omega$ ,  $V_{THM} = V_{AVL/2}$ , circuit of Figure 1,  $T_A = -40^\circ C$  to  $+85^\circ C$ , unless otherwise noted. Typical values are at  $T_A = +25^\circ C$ .) (Note 2)

PARAMETER	SYMBOL	CONDITIONS		MIN	TYP	MAX	UNITS
Minimum On-Time	t <sub>ON-MIN</sub>				90		ns
Maximum On-Time	t <sub>ON-MAX</sub>				9		μs
Minimum Off-Time	t <sub>OFF</sub>				75		ns
BAT Regulation Voltage (Note 3)	V <sub>BATREG</sub>	I <sub>BAT</sub> = 0mA, MAX8900A/ MAX8900B/ MAX8900C (Figure 10)	T <sub>A</sub> = +25°C, V <sub>THM</sub> between T1 and T3	4.179	4.200	4.221	V
			T <sub>A</sub> = -40°C to +85°C, V <sub>THM</sub> between T1 and T3	4.158	4.200	4.242	
			T <sub>A</sub> = +25°C, V <sub>THM</sub> between T3 and T4 (Note 5)	4.055	4.075	4.095	
			T <sub>A</sub> = -40°C to +85°C, V <sub>THM</sub> between T3 and T4 (Note 5)	4.034	4.075	4.100	
Charger Restart Threshold (Note 6)	V <sub>RSTRT</sub>	V <sub>THM</sub> between T1 and T3		-70	-100	-125	mV
		V <sub>THM</sub> between T3 and T4		-75			
BAT Prequalification Lower Threshold (Figure 6)	V <sub>PQLTH</sub>	V <sub>BAT</sub> rising, 180mV hysteresis		2.1			V
BAT Prequalification Upper Threshold (Figure 6) (Note 3)	V <sub>PQUTH</sub>	V <sub>BAT</sub> rising, 180mV typical hysteresis	MAX8900A/MAX8900B	2.7	2.8	2.9	V
			MAX8900C	2.9	3.0	3.1	
Fast-Charge Current	I <sub>FC</sub>	V <sub>THM</sub> between T2 and T4 (Figure 10)	R <sub>SET1</sub> = 2.87kΩ	1166	1190	1214	mA
			R <sub>SET1</sub> = 6.81kΩ	490	500	510	
			R <sub>SET1</sub> = 34.0kΩ	99	101	103	
		V <sub>THM</sub> between T1 and T2 (Figure 10); the fast-charge current is reduced to 50% the value programmed by R <sub>SET1</sub>		50			%
Fast-Charge Current Set Range		(Figure 5)	Minimum	50			mA
			Maximum	1200			
Fast-Charge Setting Resistor Range	R <sub>SET1</sub>	(Figure 5)	Minimum	2.87			kΩ
			Maximum	68.1			
Done Current	I <sub>DN</sub>	V <sub>THM</sub> between T2 and T4 (Figure 10)	R <sub>DNI</sub> = 3.83kΩ (Note 5)	93	99	105	mA
			R <sub>DNI</sub> = 7.68kΩ (Note 5)	47	50	53	
			R <sub>DNI</sub> = 38.3kΩ	9.5	10.5	11.5	
		V <sub>THM</sub> between T1 and T2 (Figure 10); the done current threshold is reduced to 50% the value programmed by R <sub>DNI</sub>		50			%
Prequalification Current	I <sub>PQ</sub>	V <sub>THM</sub> between T2 and T4 (Figure 10), V <sub>BAT</sub> = 2.6V	R <sub>DNI</sub> = 3.83kΩ (Note 5)	95	105	115	mA
			R <sub>DNI</sub> = 7.68kΩ (Note 5)	49	54	59	
			R <sub>DNI</sub> = 38.3kΩ (Note 5)	10	11.5	13	
		V <sub>THM</sub> between T1 and T2 (Figure 10); the prequalification current is reduced to 50% the value programmed by R <sub>DNI</sub>		50			%

# MAX8900A/MAX8900B/MAX8900C

## 1.2A Switch-Mode Li+ Chargers with ±22V Input Rating and JEITA Battery Temperature Monitoring

### ELECTRICAL CHARACTERISTICS (continued)

( $V_{IN} = 6V$ ,  $V_{BAT} = 4V$ ,  $R_{SET1} = 2.87k\Omega$ ,  $R_{DNI} = 3.57k\Omega$ ,  $V_{THM} = V_{AVL/2}$ , circuit of Figure 1,  $T_A = -40^\circ C$  to  $+85^\circ C$ , unless otherwise noted. Typical values are at  $T_A = +25^\circ C$ .) (Note 2)

PARAMETER	SYMBOL	CONDITIONS		MIN	TYP	MAX	UNITS
Done and Prequalification Current Set Range		(Figure 5)	Minimum		9.8		mA
			Maximum		200		
Done and Prequalification Setting Resistor Range	RDNI	(Figure 5)	Minimum		1.91		k $\Omega$
			Maximum		39.2		
Dead-Battery Charge Current	IDBAT	$0V \leq V_{BAT} \leq V_{DBAT}$			45		mA
Dead-Battery Voltage Threshold (Figure 6)	VDBAT				2.5		V
BAT Leakage Current		$V_{IN} = 0V$ , $V_{BAT} = 4.2V$ , includes LX leakage current through the inductor	$T_A = +25^\circ C$		0.02	1	$\mu A$
			$T_A = +85^\circ C$		0.05		
Charger Soft-Start Time (Note 3)	tSS				1.5		ms
<b>CHARGE TIMER</b>							
Prequalification/Dead-Battery Time	tpQ	CCT = 0.1 $\mu F$			30		min
Fast-Charge Time	tFC	CCT = 0.1 $\mu F$			180		min
Top-Off Time	tTO				16		s
Timer Accuracy				-15		+15	%
<b>THERMISTOR MONITOR</b>							
THM Hot Shutoff Threshold (60°C)	T4	$V_{THM}/AVL$ falling, 1% hysteresis (thermistor temperature rising)		21.24	22.54	23.84	%AVL
THM Hot Voltage Foldback Threshold (45°C)	T3	$V_{THM}/AVL$ falling, 1% hysteresis (thermistor temperature rising)		32.68	34.68	36.68	%AVL
THM Cold Current Foldback Threshold (15°C)	T2	$V_{THM}/AVL$ rising, 1% hysteresis (thermistor temperature falling)		57.00	60.00	63.00	%AVL
THM Cold Shutoff Threshold (-15°C/0°C)	T1	$V_{THM}/AVL$ rising, 1% hysteresis (thermistor temperature falling)	0°C, MAX8900A/MAX8900C	71.06	74.56	78.06	%AVL
			-15°C, MAX8900B	81.43	86.07	90.98	
THM Input Leakage		THM = GND or AVL	$T_A = +25^\circ C$	-0.2	0.001	+0.2	$\mu A$
			$T_A = +85^\circ C$		0.001		
<b>CHARGE ENABLE INPUT (<math>\overline{CEN}</math>)</b>							
$\overline{CEN}$ Input Voltage Low	V <sub>IL</sub>					0.6	V
$\overline{CEN}$ Input Voltage High	V <sub>IH</sub>			1.4			V
$\overline{CEN}$ Internal Pulldown Resistance	RCEN			100	200	400	k $\Omega$

# MAX8900A/MAX8900B/MAX8900C

## 1.2A Switch-Mode Li+ Chargers with ±22V Input Rating and JEITA Battery Temperature Monitoring

### ELECTRICAL CHARACTERISTICS (continued)

( $V_{IN} = 6V$ ,  $V_{BAT} = 4V$ ,  $R_{SET1} = 2.87k\Omega$ ,  $R_{DNI} = 3.57k\Omega$ ,  $V_{THM} = V_{AVL}/2$ , circuit of Figure 1,  $T_A = -40^\circ C$  to  $+85^\circ C$ , unless otherwise noted. Typical values are at  $T_A = +25^\circ C$ .) (Note 2)

PARAMETER	SYMBOL	CONDITIONS	MIN	TYP	MAX	UNITS
<b>STATUS OUTPUTS (STAT1, STAT2, STAT3)</b>						
STAT1 and STAT2 Output Voltage Low		$I_{SINK} = 1mA$		0.025	0.05	V
		$I_{SINK} = 15mA$		0.38		
STAT1 and STAT2 Output High Leakage		$V_{STAT\_} = 28V$	$T_A = +25^\circ C$	0.001	1	$\mu A$
			$T_A = +85^\circ C$	0.01		
STAT3 Output Voltage Low		$I_{SINK} = 1mA$		0.01		V
		$I_{SINK} = 15mA$		0.15	0.25	
STAT3 Output High Leakage		$V_{STAT3} = 5.5V$	$T_A = +25^\circ C$	0.001	1	$\mu A$
			$T_A = +85^\circ C$	0.01		
<b>PVL AND AVL</b>						
PVL and AVL Output Voltage		0 to 30mA internal load, $V_{IN} = 6V$ , $T_A = 0^\circ C$ to $+85^\circ C$	4.6	5.0	5.1	V
		0 to 23mA internal load, $V_{IN} = 6V$ , $T_A = -40^\circ C$ to $+85^\circ C$				
<b>THERMAL</b>						
Thermal Regulation Temperature	$T_{REG}$	Junction temperature when charge current is reduced		95		$^\circ C$
Thermal Regulation Gain	$T_{TREG}$	The charge current is decreased 6.7% of the fast-charge current setting for every degree that the junction temperature exceeds the thermal regulation temperature		6.7		$\%/^\circ C$
Thermal-Shutdown Temperature	$T_{SHDN}$	Junction temperature rising, 15 $^\circ C$ hysteresis		+155		$^\circ C$

**Note 2:** Parameters are production tested at  $T_A = +25^\circ C$ . Limits over the operating temperature range are guaranteed through correlation using statistical quality control (SQC) methods.

**Note 3:** Contact factory for alternative values.

**Note 4:**  $V_{IN}$  must be greater than  $V_{UVLO-RISING}$  for the part to operate when  $\overline{CEN}$  is pulled low. For example, if  $\overline{CEN}$  is low and the MAX8900\_ is operating with  $V_{UVLO-FALLING} < V_{IN} < V_{UVLO-RISING}$ , then toggling  $\overline{CEN}$  results in a nonoperating condition.

**Note 5:** Guaranteed by design, not production tested.

**Note 6:** When the charger is in its DONE state, it restarts when the battery voltage falls to the charger restart threshold. The battery voltage that causes a restart ( $V_{BAT-RSTRT}$ ) is  $V_{BAT-RSTRT} = 4.2V - V_{RSTRT}$ . For example, with the MAX8900A,  $V_{BAT-RSTRT} = 4.2V - 100mV = 4.1V$ .

# MAX8900A/MAX8900B/MAX8900C

## 1.2A Switch-Mode Li+ Chargers with $\pm 22V$ Input Rating and JEITA Battery Temperature Monitoring

### Typical Operating Characteristics

(Circuit of Figure 1,  $V_{IN} = 6V$ ,  $V_{BAT} = 3.6V$ ,  $T_A = +25^\circ C$ , unless otherwise noted.)

**INPUT SUPPLY CURRENT vs. INPUT VOLTAGE (DISABLED,  $V_{BAT} = 0V$ )**

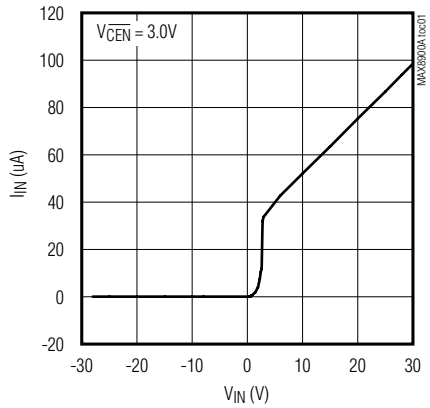

**INPUT SUPPLY CURRENT vs. INPUT VOLTAGE (DISABLED,  $V_{BAT} = 3.6V$ )**

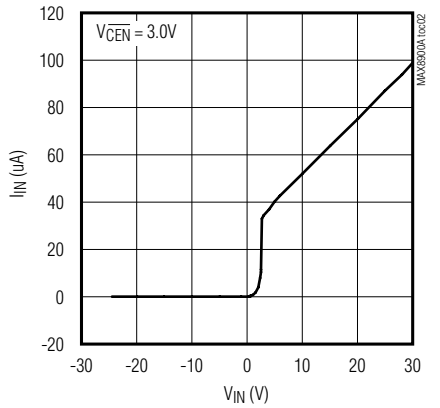

**INPUT SUPPLY CURRENT vs. INPUT VOLTAGE (PREQUALIFICATION)**

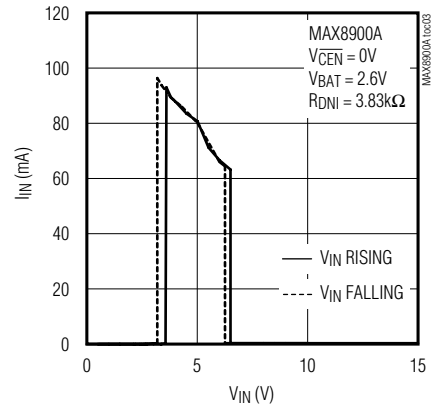

**INPUT SUPPLY CURRENT vs. INPUT VOLTAGE (CHARGING AT 1.2A)**

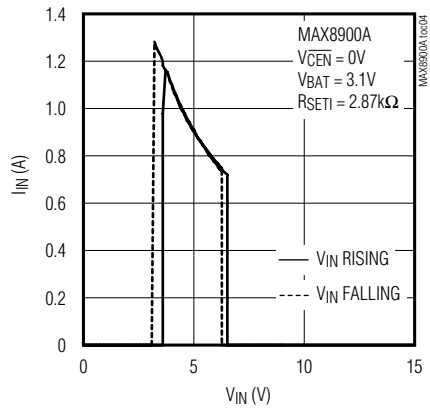

**INPUT SUPPLY CURRENT vs. INPUT VOLTAGE ( $V_{IN2BAT}$  DETAIL)**

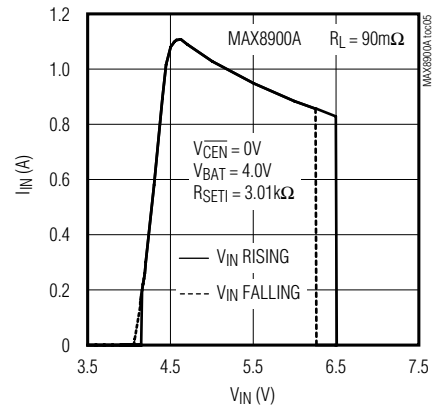

**CHARGE CURRENT vs. BATTERY VOLTAGE**

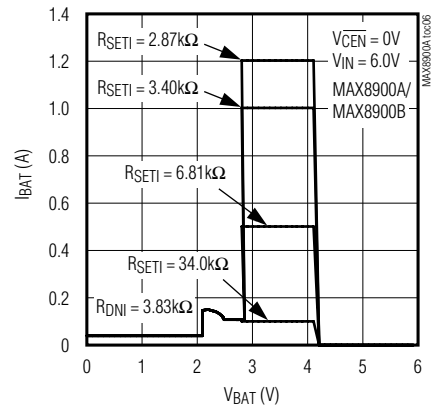

**INPUT SUPPLY CURRENT AND CHARGE CURRENT vs. INPUT VOLTAGE**

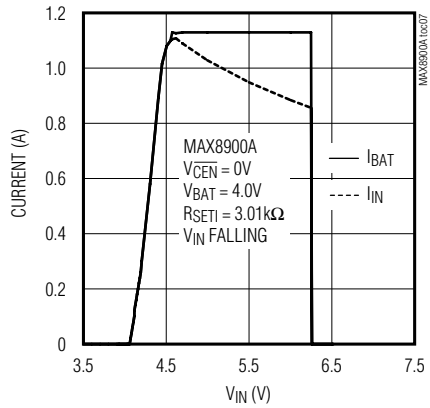

**BATTERY REGULATION VOLTAGE vs. AMBIENT TEMPERATURE**

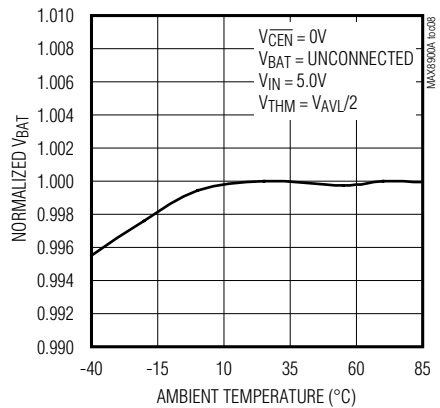

**BATTERY REGULATION VOLTAGE vs. INPUT VOLTAGE**

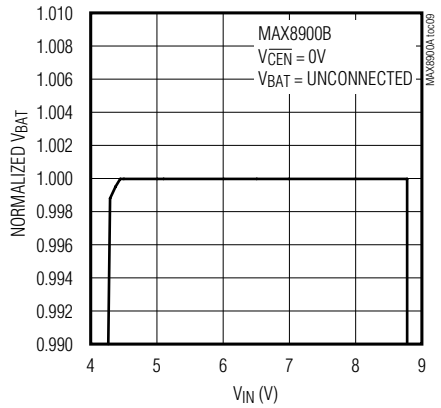



# MAX8900A/MAX8900B/MAX8900C

## 1.2A Switch-Mode Li+ Chargers with $\pm 22V$ Input Rating and JEITA Battery Temperature Monitoring

### Typical Operating Characteristics (continued)

(Circuit of Figure 1,  $V_{IN} = 6V$ ,  $V_{BAT} = 3.6V$ ,  $T_A = +25^\circ C$ , unless otherwise noted.)

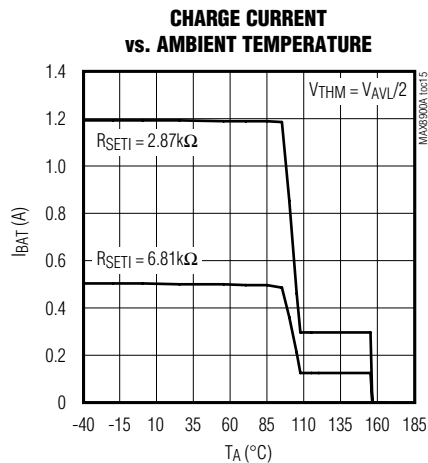
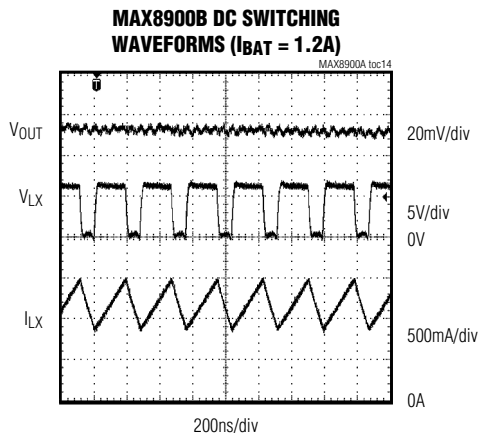
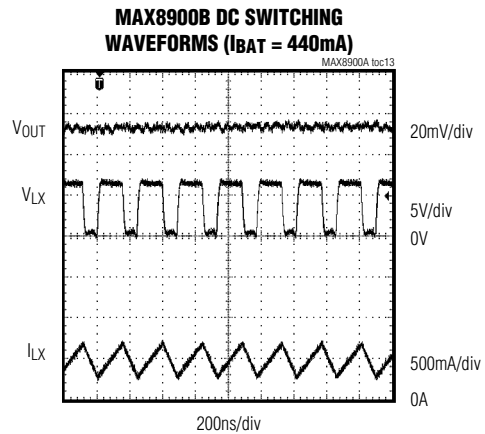
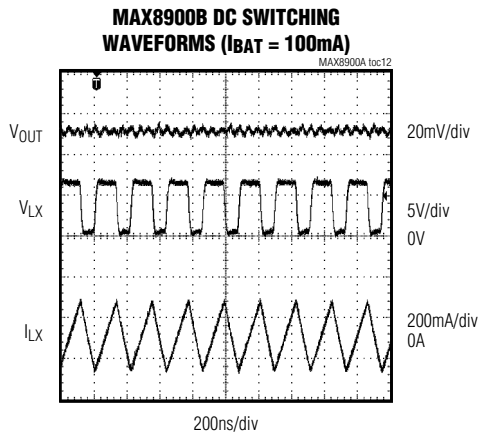
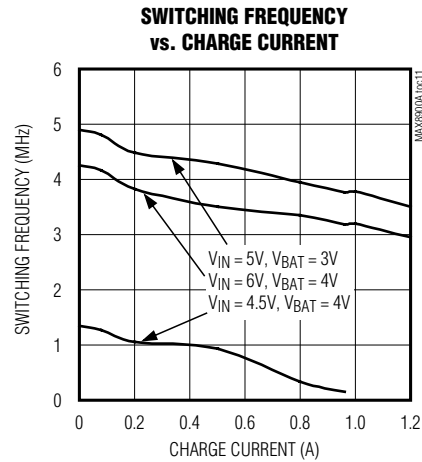
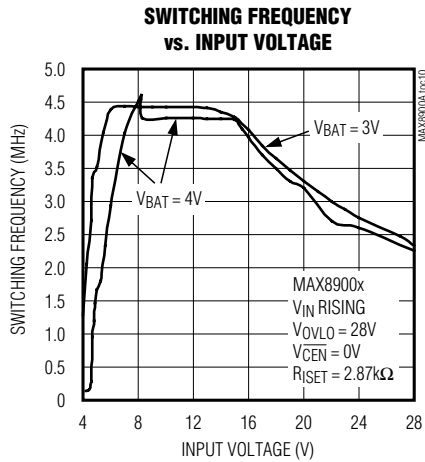

# MAX8900A/MAX8900B/MAX8900C

## 1.2A Switch-Mode Li+ Chargers with ±22V Input Rating and JEITA Battery Temperature Monitoring

### Typical Operating Characteristics (continued)

(Circuit of Figure 1,  $V_{IN} = 6V$ ,  $V_{BAT} = 3.6V$ ,  $T_A = +25^\circ C$ , unless otherwise noted.)

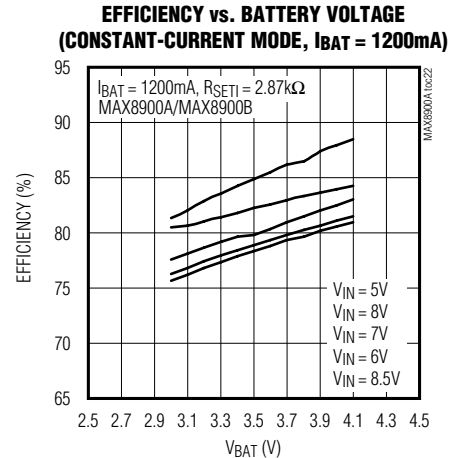
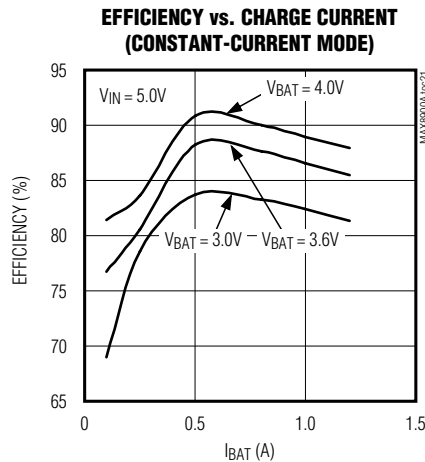
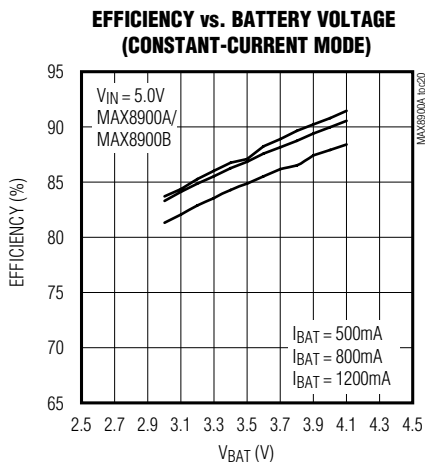
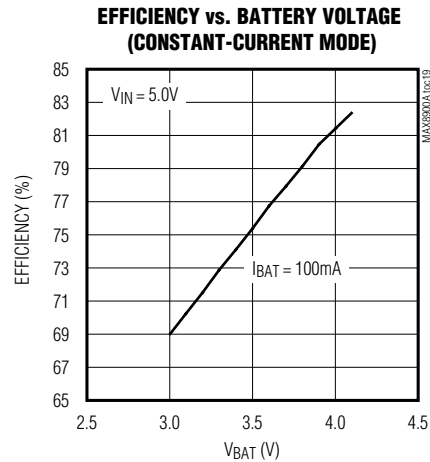
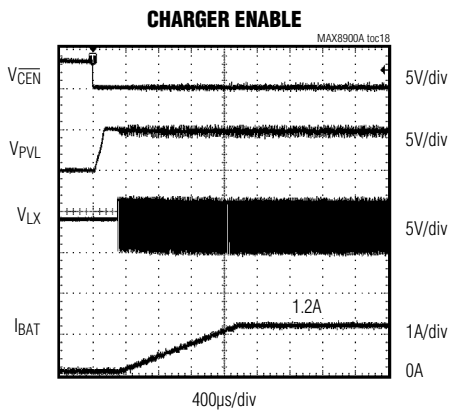
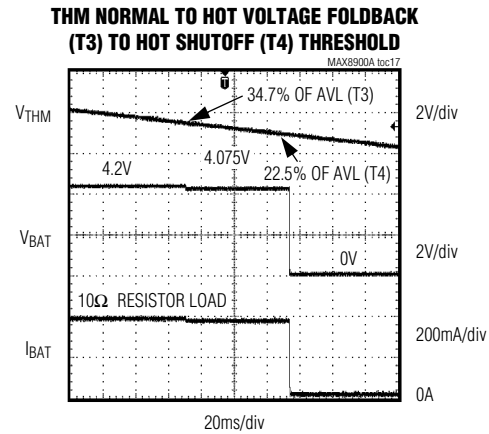
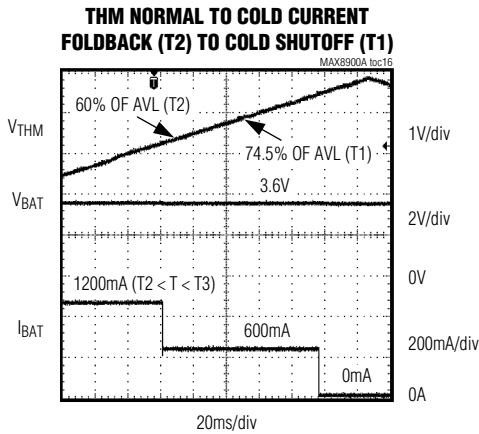

# MAX8900A/MAX8900B/MAX8900C

## 1.2A Switch-Mode Li+ Chargers with $\pm 22V$ Input Rating and JEITA Battery Temperature Monitoring

### Typical Operating Characteristics (continued)

(Circuit of Figure 1,  $V_{IN} = 6V$ ,  $V_{BAT} = 3.6V$ ,  $T_A = +25^\circ C$ , unless otherwise noted.)

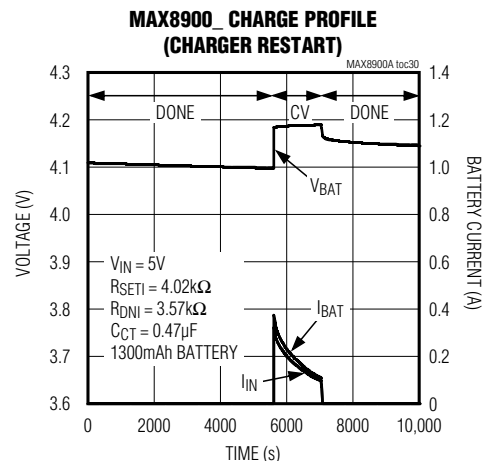
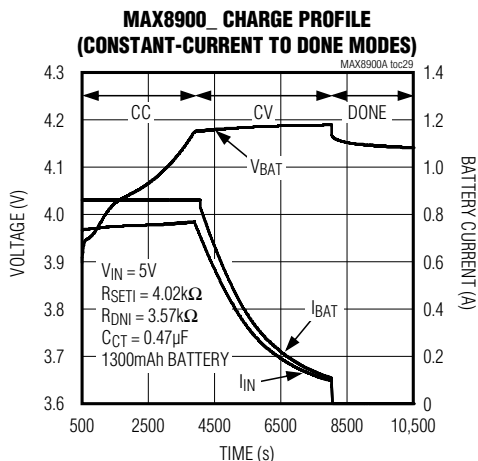
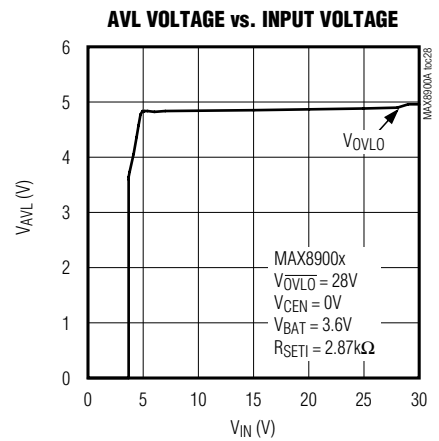
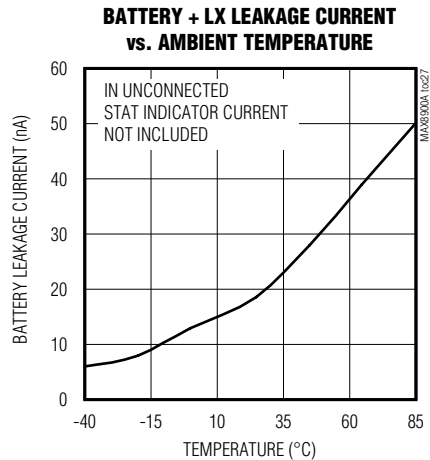
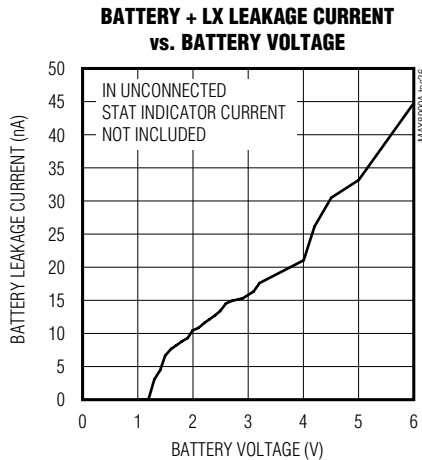
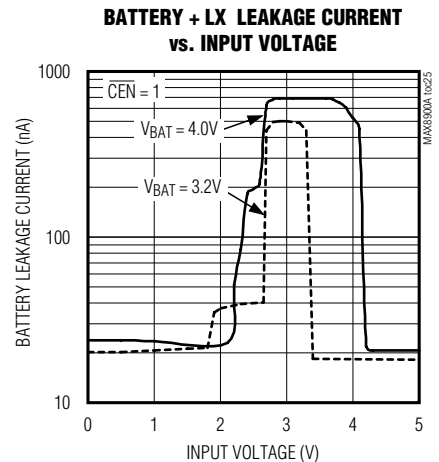
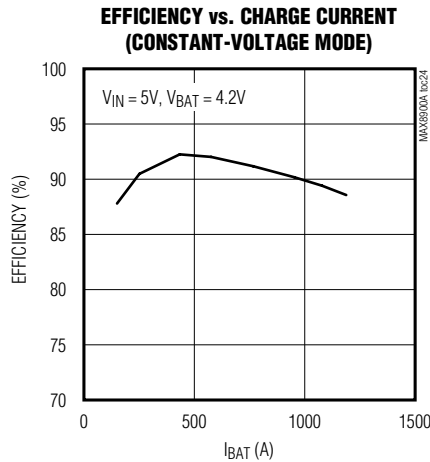
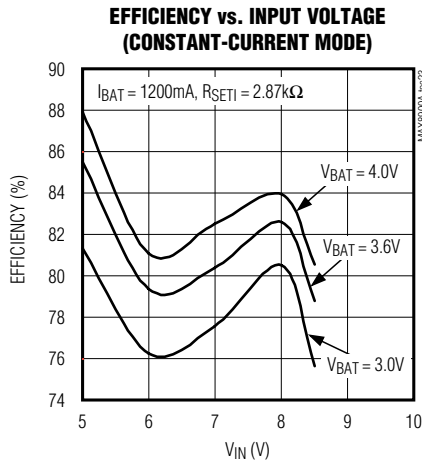

# MAX8900A/MAX8900B/MAX8900C

## 1.2A Switch-Mode Li+ Chargers with $\pm 22V$ Input Rating and JEITA Battery Temperature Monitoring

### Typical Operating Characteristics (continued)

(Circuit of Figure 1,  $V_{IN} = 6V$ ,  $V_{BAT} = 3.6V$ ,  $T_A = +25^\circ C$ , unless otherwise noted.)

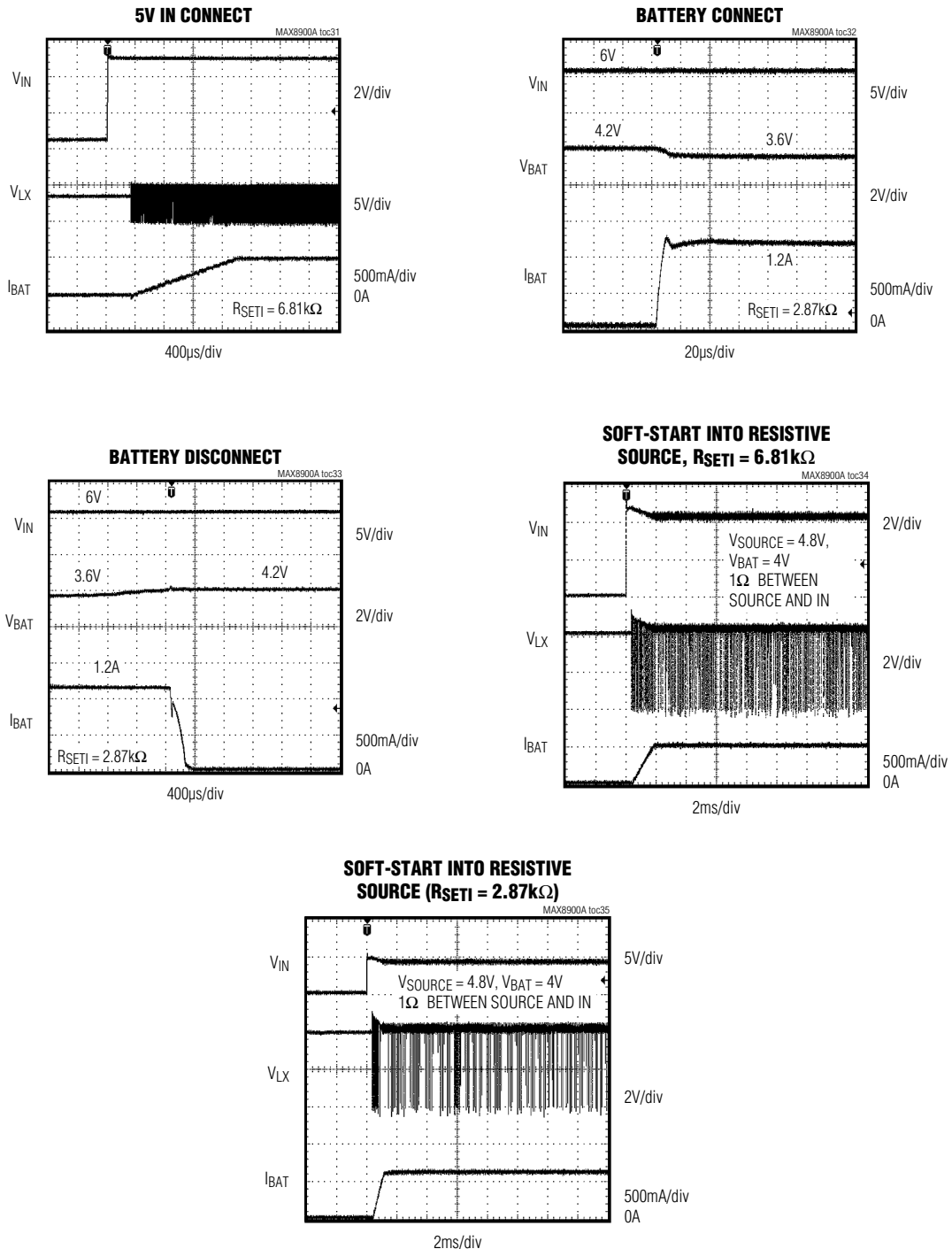

# MAX8900A/MAX8900B/MAX8900C

## 1.2A Switch-Mode Li+ Chargers with ±22V Input Rating and JEITA Battery Temperature Monitoring

### Pin Configuration

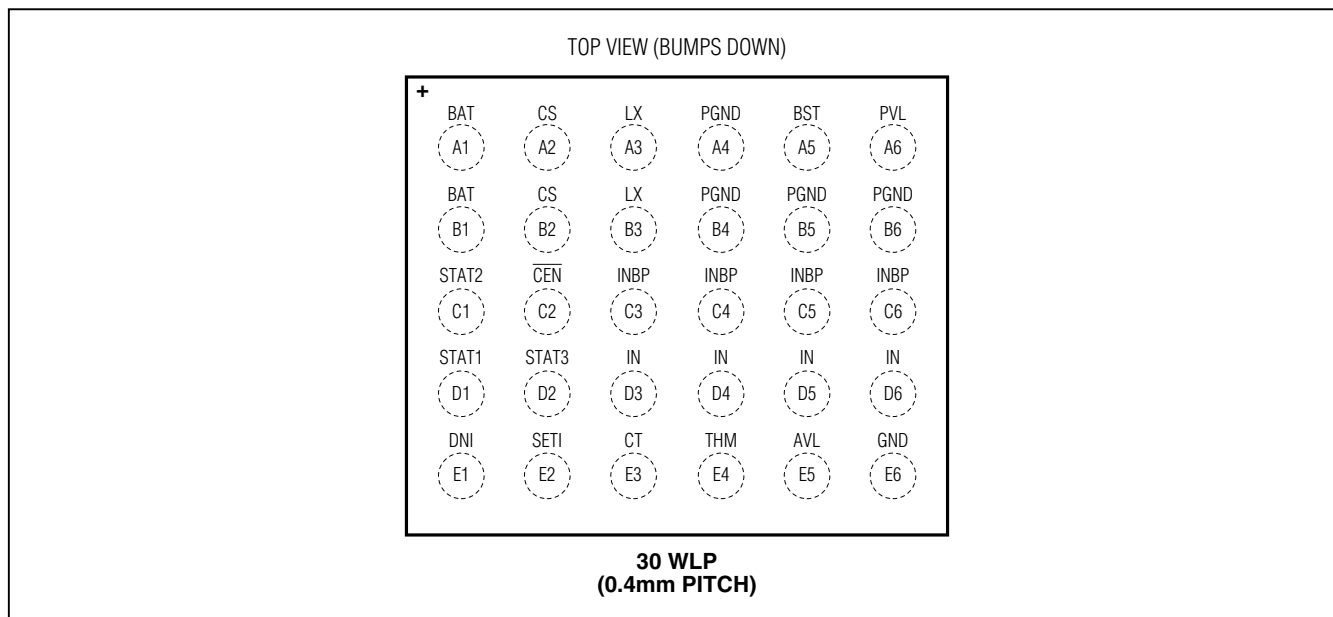

### Pin Description

PIN	NAME	FUNCTION
A1, B1	BAT	Connection to Battery. Connect to a single-cell Li+/Li-Poly battery from BAT to PGND. Connect both BAT pins together externally. Bypass BAT to PGND with a 2.2µF ceramic capacitor.
A2, B2	CS	40mΩ Current-Sense Node. Connect the inductor from LX to CS. Connect both CS pins together externally.
A3, B3	LX	Inductor Switching Node. Connect the inductor between LX and CS. Connect both LX pins together externally. When enabled ( $\overline{CEN} = 0$ ), LX switches between INBP and PGND to control the battery charging. When disabled ( $\overline{CEN} = 1$ ), the LX switches are high-impedance however they still have body diodes as shown in Figure 3.
A4, B4, B5, B6	PGND	Power Ground for Step-Down Low-Side Synchronous n-Channel MOSFET. Connect all PGND pins together externally.
A5	BST	Supply for High-Side n-Channel Gate Driver. Bypass BST to LX with a 0.1µF ceramic capacitor.
A6	PVL	5V Linear Regulator to Power Internal Circuits. PVL also charges the BST capacitor. Bypass PVL to PGND with a 1.0µF ceramic capacitor. Powering external loads from PVL is not recommended.
C1	STAT2	Status Output 2. STAT2 is an open-drain output that has a 30V absolute maximum rating and a typical pulldown resistance of 25Ω. For the MAX8900A, STAT1 and STAT2 indicate different states as shown in Table 4. For the MAX8900B/MAX8900C, STAT1, STAT2, and STAT3 indicate different operating states of the MAX8900_ as shown in Table 3.
C2	$\overline{CEN}$	Charge Enable Input. $\overline{CEN}$ has an internal 200kΩ pulldown resistor. Pull $\overline{CEN}$ low or leave it unconnected to enable the MAX8900_. Drive $\overline{CEN}$ high to disable the MAX8900_. Note: $V_{IN}$ must be greater than $V_{UVLO-RISING}$ for the MAX8900_ to operate when $\overline{CEN}$ is pulled low. For example, if $\overline{CEN}$ is low and the MAX8900_ is operating with $V_{UVLO-FALLING} < V_{IN} < V_{UVLO-RISING}$ , then toggling $\overline{CEN}$ results in a nonoperating condition.

# MAX8900A/MAX8900B/MAX8900C

## 1.2A Switch-Mode Li+ Chargers with $\pm 22V$ Input Rating and JEITA Battery Temperature Monitoring

### Pin Description (continued)

PIN	NAME	FUNCTION
C3–C6	INBP	Power Input Bypass. Connect all INBP pins together externally. Bypass INBP to PGND with a 0.47 $\mu$ F ceramic capacitor.
D1	STAT1	Status Output 1. STAT1 is an open-drain output that has a 30V absolute maximum rating and a typical internal pulldown resistance of 25 $\Omega$ . For the MAX8900A, STAT1 and STAT2 indicate different states as shown in Table 4. For the MAX8900B/MAX8900C, STAT1, STAT2, and STAT3 indicate different operating states of the MAX8900_ as shown in Table 3.
D2	STAT3	Status Output 3. STAT3 is an open-drain output that is a 6V absolute maximum rating and a typical pulldown resistance of 10 $\Omega$ . For the MAX8900A, STAT1 and STAT2 indicate different states as shown in Table 4. For the MAX8900B/MAX8900C, STAT1, STAT2, and STAT3 indicate different operating states of the MAX8900_ as shown in Table 3.
D3–D6	IN	Power Input. IN is capable of delivering 1.2A to the battery and/or system. Connect all IN pins together externally. Bypass IN to PGND with a 0.47 $\mu$ F ceramic capacitor.
E1	DNI	Done/Prequalification Program Input. DNI is a dual function pin that sets both the done current threshold and the prequalification charge rate. Connect a resistor from DNI to GND to set the threshold between 10mA and 200mA. DNI is pulled to GND during shutdown.
E2	SETI	Fast-Charge Current Program Input. Connect a resistor from SETI to GND to set the fast-charge current from 0.05A to 1.2A. SETI is pulled to GND during shutdown.
E3	CT	Charge Timer Set Input. A capacitor ( $C_{CT}$ ) from CT to GND sets the prequalification/dead-battery and fast-charge fault timers. Use 0.1 $\mu$ F for 180-minute fast-charge time limit and 30-minute prequalification/dead-battery time limit. Connect to GND to disable the timer.
E4	THM	Thermistor Input. Connect a negative temperature coefficient (NTC) thermistor from THM to GND. Connect a resistor equal to the thermistor's +25 $^{\circ}$ C resistance from THM to AVL. Thermistor adjusts the charge current and termination voltage as described in the JEITA specification for safe use of secondary Li+ batteries. See Figure 10. To disable the THM operation, bias $V_{THM}$ midway between AVL and GND.
E5	AVL	5V Linear Regulator to Power Low-Noise Internal Circuits. Bypass AVL to GND with a 0.1 $\mu$ F ceramic capacitor. Powering external loads from AVL is not recommended.
E6	GND	Ground. GND is the low-noise ground connection for the internal circuitry. See the <i>PCB Layout</i> section for more details.

# MAX8900A/MAX8900B/MAX8900C

## 1.2A Switch-Mode Li+ Chargers with $\pm 22V$ Input Rating and JEITA Battery Temperature Monitoring

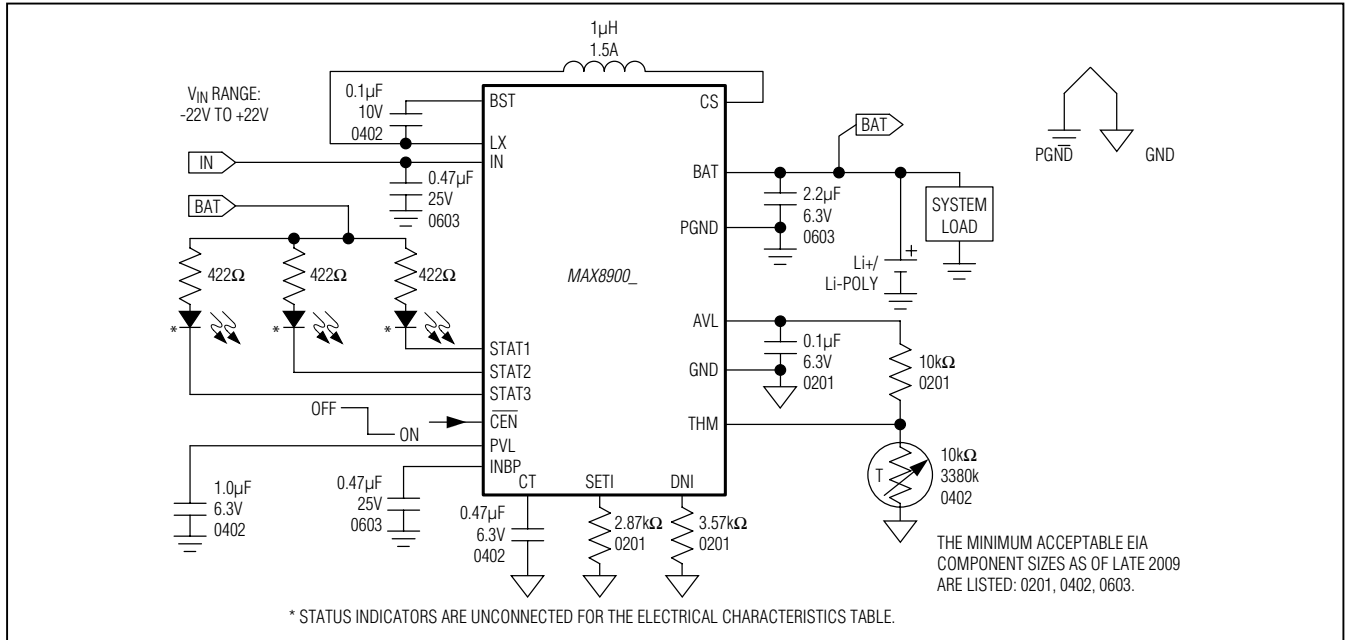

Figure 1. Applications Circuit: Single SET1 Resistor, Status Indicators Connected to LEDs

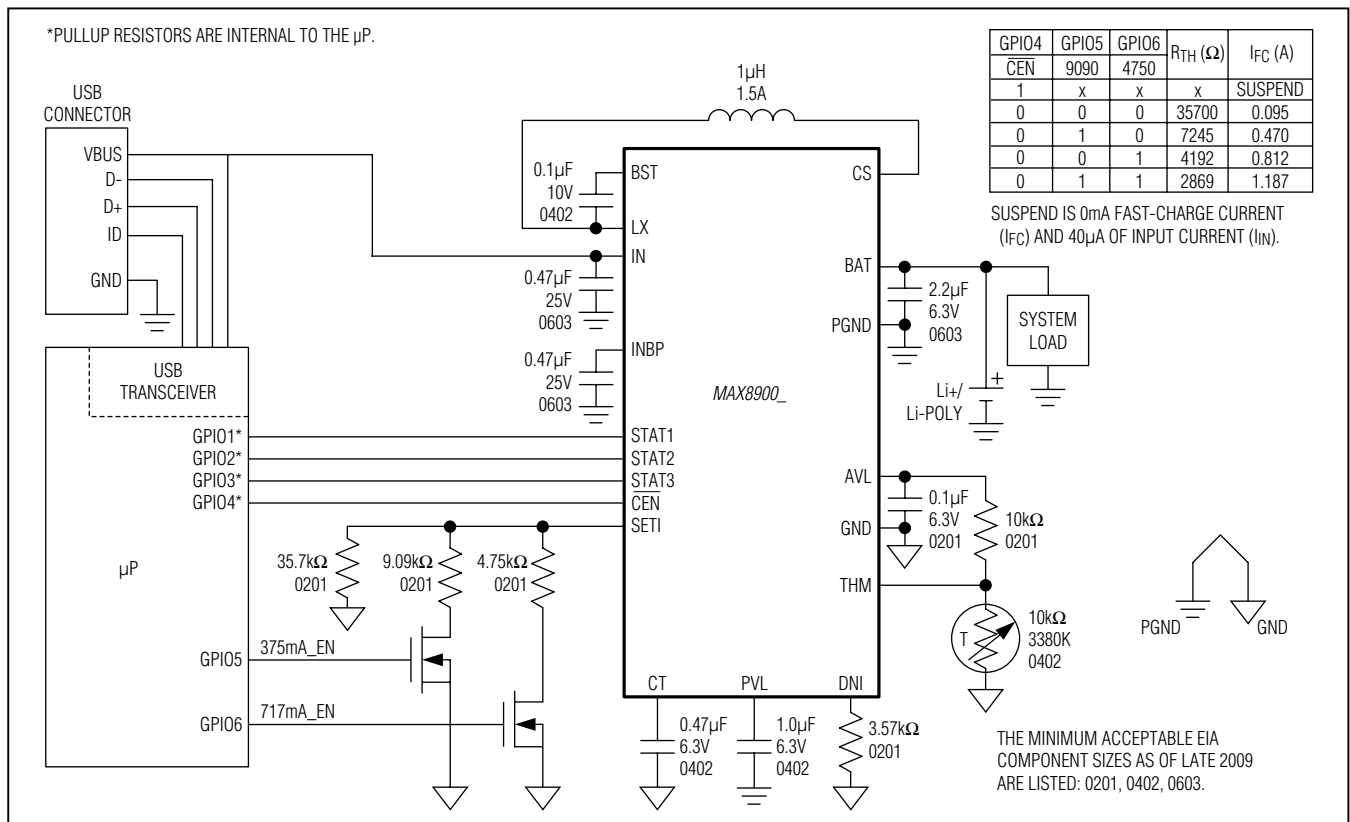

Figure 2. Applications Circuit: Multiple Charge Rates Managed by µP to Be USB Compliant, Status Indicators Connected to a µP

# MAX8900A/MAX8900B/MAX8900C

## 1.2A Switch-Mode Li+ Chargers with $\pm 22V$ Input Rating and JEITA Battery Temperature Monitoring

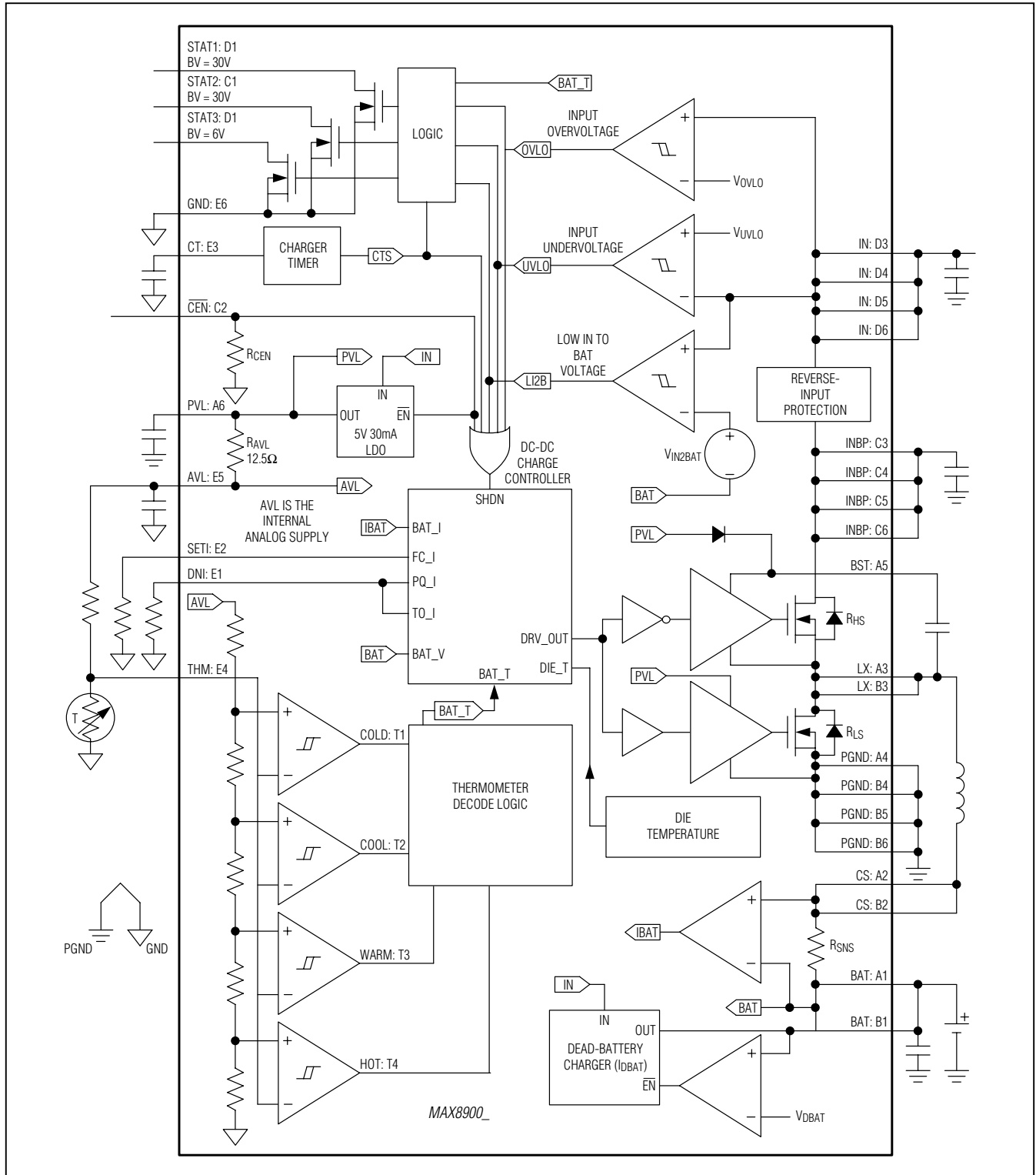

Figure 3. Functional Diagram



# MAX8900A/MAX8900B/MAX8900C

## 1.2A Switch-Mode Li+ Chargers with ±22V Input Rating and JEITA Battery Temperature Monitoring

### Detailed Description

The MAX8900\_ is a full-featured, high-frequency switch-mode charger for a 1-cell Li+ or Li-Poly battery. It delivers up to 1.2A to the battery from 3.4V to 6.3V (MAX8900A/MAX8900C) or 3.4V to 8.7V (MAX8900B). Contact the factory for input operating voltage ranges up to +20V. The 3.25MHz switch-mode charger is ideally suited to small portable devices such as headsets and ultra-portable media players because it minimizes component size and heat.

Several features make the MAX8900\_ ideal for high reliability systems. The MAX8900\_ is protected against input voltages as high as +22V and as low as -22V. Battery protection features include low voltage prequalification, charge fault timer, die temperature monitoring, and battery temperature monitoring. The battery temperature monitoring adjusts the charge current and termination voltage as described in the JEITA (Japan Electronics and Information Technology Industries Association) specification for safe use of secondary Li+ batteries. The full title of the standard is *A Guide to the Safe Use of Secondary Lithium Ion Batteries in Notebook-Type Personal Computers*, April 20, 2007.

Charge parameters are easily adjustable with external components. An external resistance adjusts the charge current from 50mA to 1200mA. Another external resistance adjusts the prequalification and done current thresholds from 10mA to 200mA. The done current threshold is very accurate achieving ±1mA at the 10mA level. The charge timer is adjustable with an external capacitor.

### Control Scheme

A proprietary hysteretic current PWM control scheme ensures high efficiency, fast switching, and physically tiny external components. Inductor ripple current is internally set to provide 3.25MHz. At very high duty factors, when the input voltage is lowered close to the output voltage, the steady-state duty ratio does not allow 3.25MHz operation because of the minimum off-time. The controller then provides minimum off-time, peak current regulation. Similarly, when the input voltage is too high to allow 3.25MHz operation due to the minimum on-time, the controller becomes a minimum on-time, valley current regulator. In this way, the ripple current in the inductor is always as small as possible to reduce the output ripple voltage. The inductor ripple current is made to vary with input and output voltage in a way that reduces frequency variation.

### Soft-Start

To prevent input current transients, the rate of change of the input current (di/dt) and charge current is limited. When the input is valid, the charge current ramps from 0mA to the fast-charge current value in 1.5ms. Charge current also soft-starts when transitioning from the prequalification state to the fast-charge state. There is no di/dt limiting when transitioning from the done state to the fast-charge state (Figures 7 and 8). Similarly, if RSETI is changed suddenly when using a switch or variable resistor at SETI as shown in Figure 2 there is no di/dt current limiting.

### Setting the Fast-Charge Current (SETI)

As shown in Figure 4, a resistor from SETI to ground (RSETI) sets the fast-charge current (IFC). The MAX8900\_ supports values of IFC from 50mA to 1200mA. Select RSETI as follows:

$$IFC = 3405V/RSETI$$

Determine the optimal IFC for a given system by considering the characteristics of the battery and the capabilities of the charge source.

**Example 1:** If you are using a 5V ±5% 1A charge source along with an 800mAh battery that has a 1C fast-charge rating, then choose RSETI to be 4.42kΩ ±1%. This value provides a typical charge current of 770mA. Given the ±2% six sigma limit on the MAX8900\_ fast-charge current accuracy along with the ±1% accuracy of the resistor, we can reasonably expect that the 770mA typical value has an accuracy of ±2.2% ( $2.2 \approx \sqrt{2^2 + 1^2}$ ) or ±17mA. Furthermore, since the MAX8900\_ charger uses a step-down converter topology, we can guarantee that the input current is less than or equal to the output current so we do not violate the 1A rating of the charge source.

Depending on its mode of operation, the MAX8900\_ controls the voltage at SETI to be between 0V and 1.5V. Avoid adding capacitance directly to the SETI pin that exceeds 10pF.

As a protection feature, if the battery temperature is between the T2 and T4 thresholds and SETI is shorted to ground, then the MAX8900\_ latches off the battery charger and enters the timer fault state. This protection feature is disabled outside of fast-charge, top-off, done mode and inside thermal foldback. Furthermore, if SETI is unconnected, then the battery fast-charge current is 0A.

# MAX8900A/MAX8900B/MAX8900C

## 1.2A Switch-Mode Li+ Chargers with ±22V Input Rating and JEITA Battery Temperature Monitoring

### Setting the Prequalification Current and Done Threshold (DNI)

As shown in Figure 5, a resistor from DNI to ground (RDNI) sets the prequalification current (IPQ) and done current (IDN). The MAX8900\_ supports values of RDNI from 1.19kΩ to 38.2kΩ. Select RDNI as follows:

$$IDN = 384V/RDNI \quad IPQ = 415V/RDNI$$

Determine the optimal IPQ and IDN for a given system by considering the characteristics of the battery.

Depending on its mode of operation, the MAX8900\_ controls the voltage at DNI from 0 to 1.5V. Avoid adding capacitance directly to the SETI pin that exceeds 10pF.

As shown in Figure 10, the prequalification current and done threshold is set to 50% of programmed value when  $T1 < THM < T2$ , and 100% of programmed value when  $T2 < THM < T4$ .

As a protection feature, if the battery temperature is between the T2 and T4 thresholds and DNI is shorted to ground, then the MAX8900\_ latches off the battery charger and enters the timer fault state. This protection feature is disabled inside of dead-battery mode and thermal foldback. Furthermore, if DNI is unconnected, then the prequalification and done current is 0A and the charge timer prevents the MAX8900\_ from indefinitely operating in its done state.

### Charge Enable Input ( $\overline{CEN}$ )

$\overline{CEN}$  is a digital input. Driving  $\overline{CEN}$  high disables the battery charger. Pull  $\overline{CEN}$  low or leave it unconnected

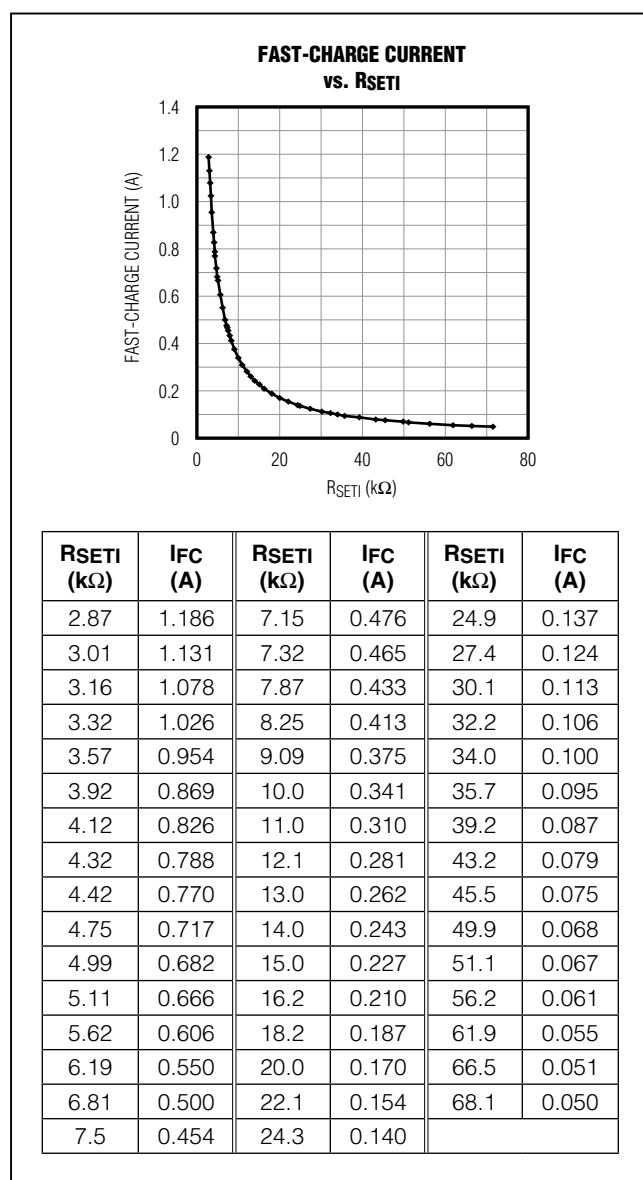

Figure 4. Fast-Charge Current vs. RSETI ([www.maxim-ic.com/tools/other/software/MAX8900-RSETI.XLS](http://www.maxim-ic.com/tools/other/software/MAX8900-RSETI.XLS))

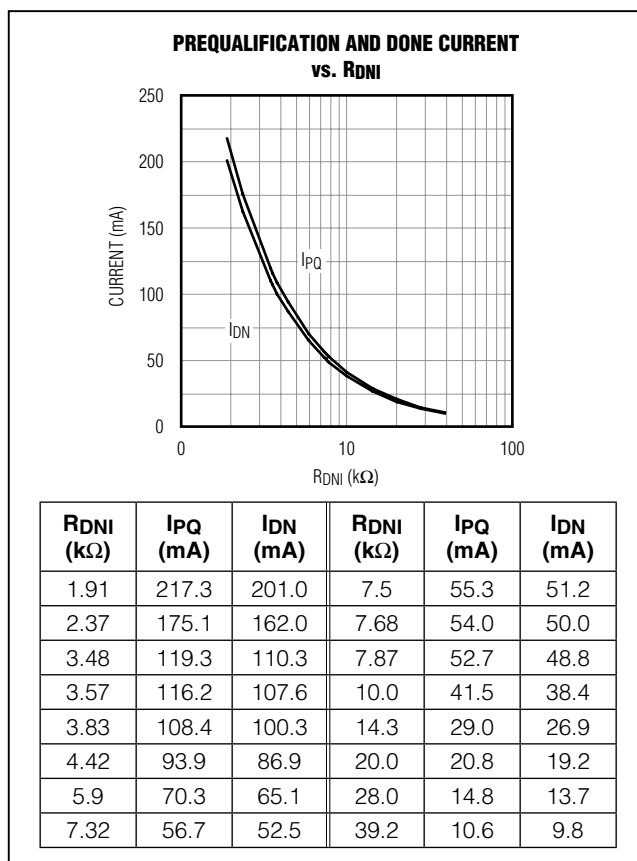

Figure 5. Prequalification Current and Done Threshold vs. RDNI ([www.maxim-ic.com/tools/other/software/MAX8900-DNI.XLS](http://www.maxim-ic.com/tools/other/software/MAX8900-DNI.XLS))

# MAX8900A/MAX8900B/MAX8900C

## 1.2A Switch-Mode Li+ Chargers with ±22V Input Rating and JEITA Battery Temperature Monitoring

to enable the MAX8900\_.  $\overline{\text{CEN}}$  has an internal 200k $\Omega$  pulldown resistor. When disabled, the MAX8900\_ supply current is reduced, the step-down converter high-side and low-side switches are off, and the AVL is disabled.

In many systems, there is no need for the system controller (typically a microprocessor ( $\mu\text{P}$ )) to disable the charger because the MAX8900\_ independently manages the charger. In these situations,  $\overline{\text{CEN}}$  can be connected to ground or left unconnected. **Note:** if  $\overline{\text{CEN}}$  is permanently connected to ground or left unconnected, the input power must be cycled to escape from a timer fault state (see Figures 7 and 8 for more information).

$V_{\text{IN}}$  must be greater than  $V_{\text{UVLO-RISING}}$  for the MAX8900\_ to operate when  $\overline{\text{CEN}}$  is pulled low. For example, if  $\overline{\text{CEN}}$  is low and the MAX8900\_ is operating with  $V_{\text{UVLO-FALLING}} < V_{\text{IN}} < V_{\text{UVLO-RISING}}$ , then toggling  $\overline{\text{CEN}}$  results in a nonoperating condition.

### Charger States

The MAX8900\_ utilizes several charging states to safely and quickly charge batteries as shown in Figure 7. Figure 6 shows an exaggerated view of a Li+/Li-Poly battery progressing through the following charge states when the die and battery are close to room temperature: dead battery  $\rightarrow$  prequalification  $\rightarrow$  fast-charge  $\rightarrow$  top-off  $\rightarrow$  done.

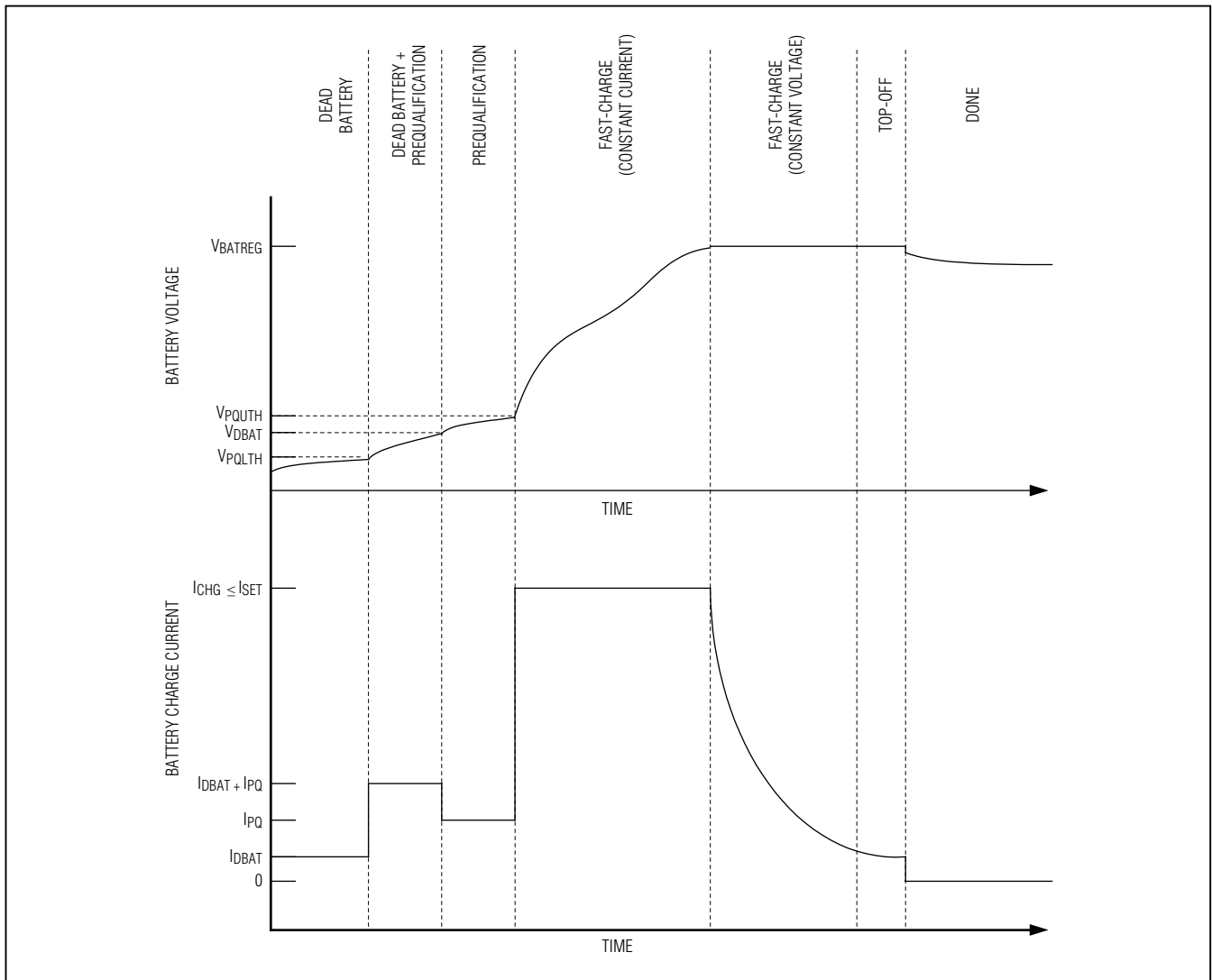

Figure 6. Li+/Li-Poly Charge Profile

# MAX8900A/MAX8900B/MAX8900C

## 1.2A Switch-Mode Li+ Chargers with ±22V Input Rating and JEITA Battery Temperature Monitoring

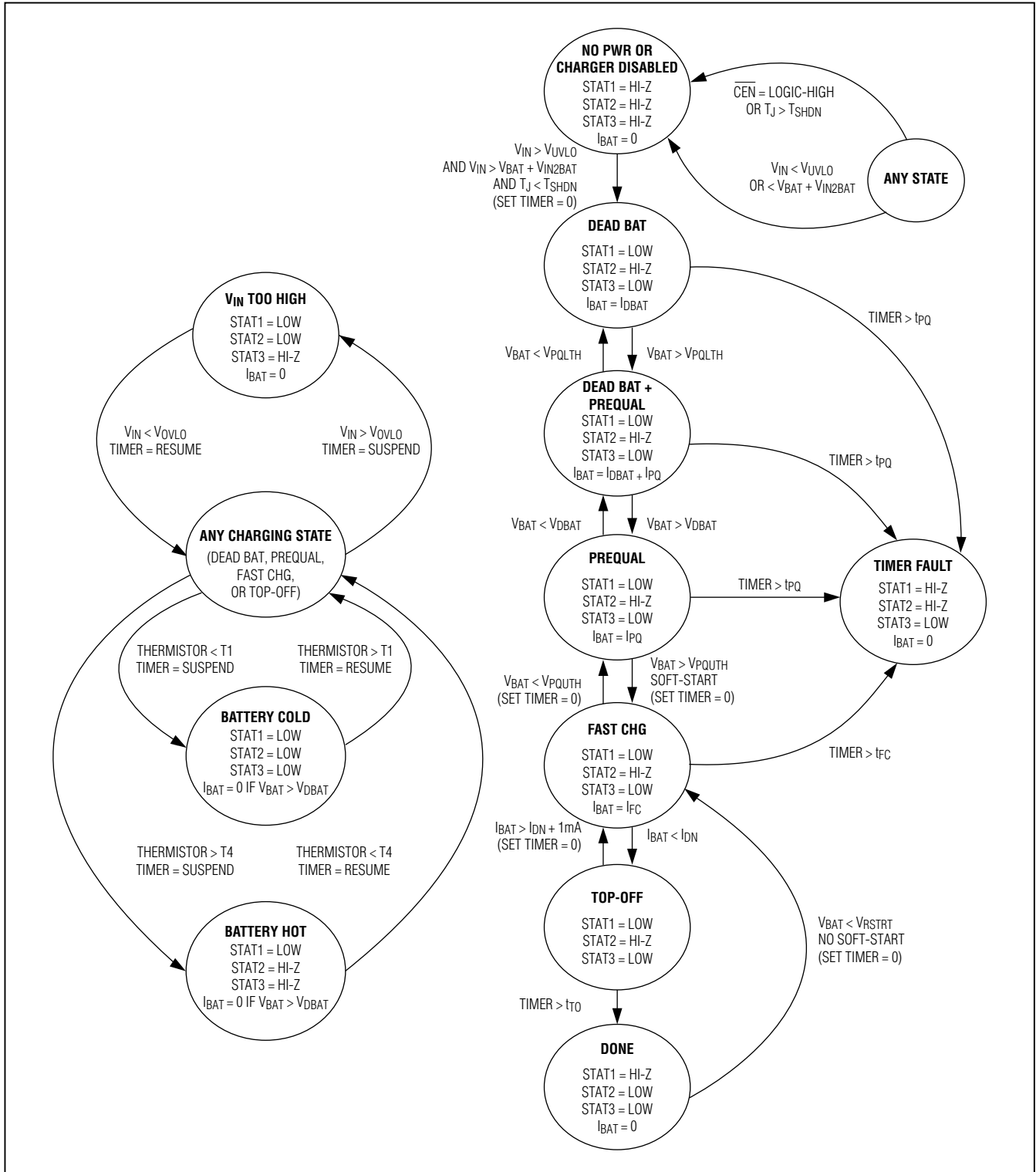

Figure 7. Charger State Diagram (3-Pin Status)

# MAX8900A/MAX8900B/MAX8900C

## 1.2A Switch-Mode Li+ Chargers with ±22V Input Rating and JEITA Battery Temperature Monitoring

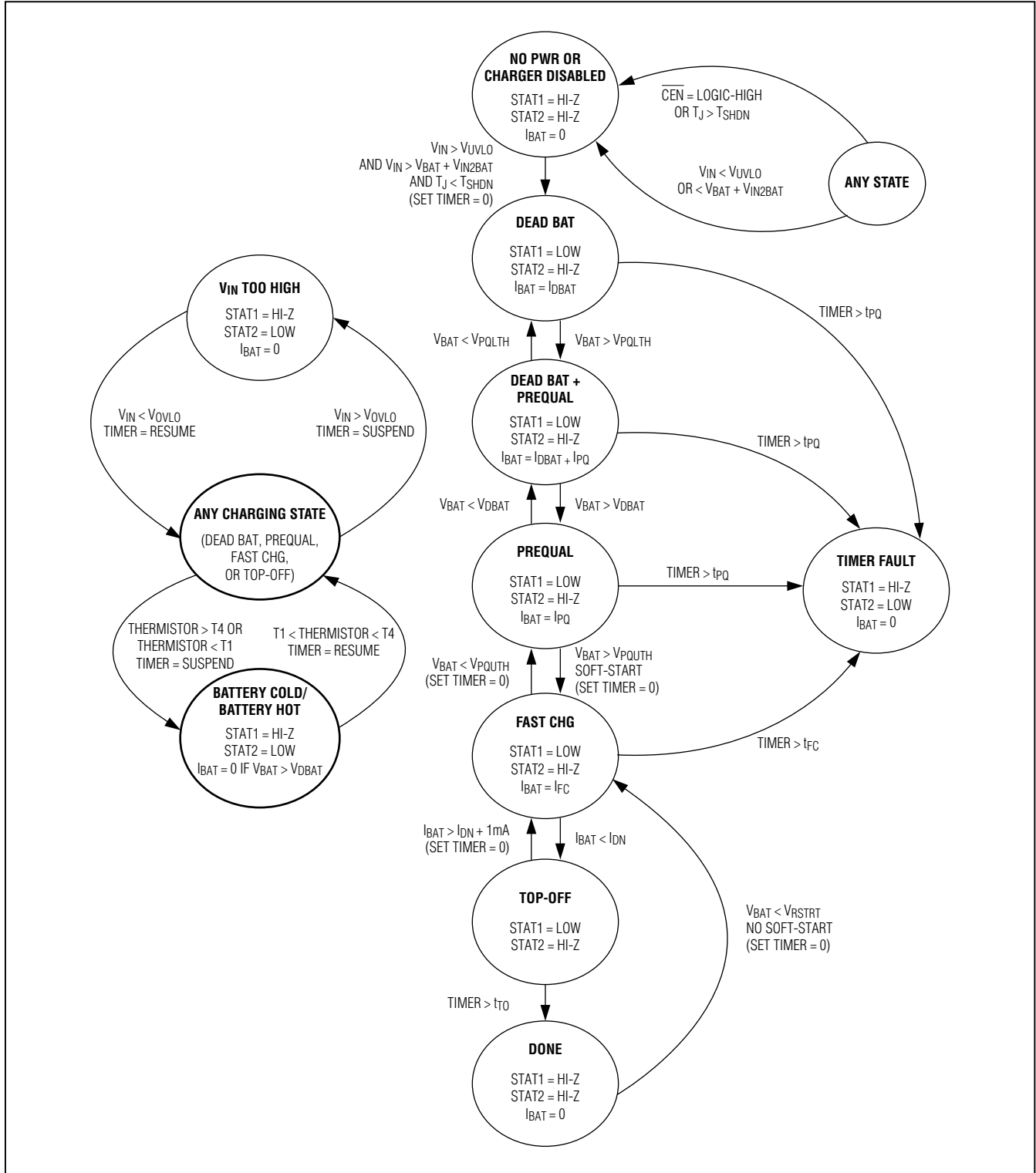

Figure 8. Charger State Diagram (2-Pin Status)

# MAX8900A/MAX8900B/MAX8900C

## 1.2A Switch-Mode Li+ Chargers with $\pm 22V$ Input Rating and JEITA Battery Temperature Monitoring

### Charger Disabled State

When  $\overline{CEN}$  is high or the input voltage is out of range, the MAX8900\_ disables the charger. To exit this state,  $\overline{CEN}$  must be low and the input voltage must be within its valid range.

### Dead-Battery State

When a deeply discharged battery is inserted with a voltage of less than  $V_{PQLTH}$ , the MAX8900\_ disables the switching charger and linearly charges with  $I_{DBAT}$ . If the MAX8900\_ remains in this dead-battery state for longer than  $t_{PQ}$ , then it transitions to the timer fault state. This dead-battery state prevents the MAX8900\_ from dissipating excessive power in the event of a shorted battery. Once  $V_{BAT}$  increases beyond  $V_{PQLTH}$ , the MAX8900\_ transitions to the dead battery + prequalification state.

### Dead Battery + Prequalification State

The dead battery + prequalification state occur when the battery voltage is greater than  $V_{PQLTH}$  and less than  $V_{DBAT}$ . In this state, both the linear dead-battery charger and the switching charger are on and delivering current to the battery. The total battery current is  $I_{DBAT} + I_{PQ}$ . If the MAX8900\_ remains in this state for longer than  $t_{PQ}$ , then it transitions to the timer fault state. A normal battery typically stays in the dead-battery + prequalification state for several minutes or less and when the battery voltage rises above  $V_{DBAT}$ , the MAX8900\_ transitions to the prequalification state.

### Prequalification State

The prequalification state occurs when the battery voltage is greater than  $V_{DBAT}$  and less than  $V_{PQUTH}$ .

In this state, the linear dead-battery charger is turned off and only the switching charger is on and delivering current to the battery. The total battery current is  $I_{PQ}$ . If the MAX8900\_ remains in this state for longer than  $t_{PQ}$ , then the MAX8900\_ transitions to the timer fault state. A normal battery typically stays in the prequalification state for several minutes or less and when the battery voltage rises above  $V_{PQUTH}$ , the MAX8900\_ transitions to the fast-charge constant current state.

As shown in Figure 10, the prequalification current and done threshold is set to 50% of programmed value when  $T1 < THM < T2$ , and 100% of programmed value when  $T2 < THM < T4$ .

### Fast-Charge Constant Current State

The fast-charge constant current state occurs when the battery voltage is greater than  $V_{PQUTH}$  and less than  $V_{BATREG}$ . In this state, the switching charger is on and

delivering current to the battery. The total battery current is  $I_{FC}$ . If the MAX8900\_ remains in this state and the fast-charge constant voltage state for longer than  $t_{FC}$ , then the MAX8900\_ transitions to the timer fault state. When the battery voltage rises to  $V_{BATREG}$ , the MAX8900\_ transitions to the fast-charge constant voltage state. As shown in Figure 10, the fast-charge constant current is set to 50% of programmed value when  $T1 < THM < T2$ , and 100% of programmed value when  $T2 < THM < T4$ .

The MAX8900\_ dissipates the most power in the fast-charge constant current state. This power dissipation causes the internal die temperature to rise. If the die temperature exceeds  $T_{REG}$ ,  $I_{FC}$  is reduced. See the *Thermal Foldback* section for more detail.

If there is low input voltage headroom ( $V_{IN} - V_{BAT}$ ), then  $I_{FC}$  decreases due to the impedance from IN to BAT. See Figure 13 for more detail.

### Fast-Charge Constant Voltage State

The fast-charge constant voltage state occurs when the battery voltage is at the  $V_{BATREG}$  and the charge current is greater than  $I_{DN}$ . In this state, the switching charger is on and delivering current to the battery. The MAX8900\_ maintains  $V_{BATREG}$  and monitors the charge current to detect when the battery consumes less than the  $I_{DN}$  current. When the charge current decreases below the  $I_{DN}$  threshold, the MAX8900\_ transitions to the top-off state. If the MAX8900\_ remains in the fast-charge constant current state and this state for longer than  $t_{FC}$ , then the MAX8900\_ transitions to the timer fault state. Please note when the battery temperature is between  $T3$  and  $T4$  the BAT regulation voltage is reduced to 4.075V.

The MAX8900\_ offers an adjustable done current threshold ( $I_{DN}$ ) from 10mA to 200mA. The accuracy of the top-off current threshold is  $\pm 1mA$  when it is set for 10mA. This accurate threshold allows the maximum amount of charge to be stored in the battery before the MAX8900\_ transitions into done state.

### Top-Off State

The top-off state occurs when the battery voltage is at  $V_{BATREG}$  and the battery current decreases below  $I_{DN}$ . In this state, the switching charger is on and delivers current to the battery. The MAX8900\_ maintains  $V_{BATREG}$  for a specified time ( $t_{TO}$ ). When  $t_{TO}$  expires, the MAX8900\_ transitions to the done state. If the charging current increases to  $I_{DN} + 1mA$  before  $t_{TO}$  expires, then the charger re-enters the fast-charge constant voltage state.

# MAX8900A/MAX8900B/MAX8900C

## 1.2A Switch-Mode Li+ Chargers with ±22V Input Rating and JEITA Battery Temperature Monitoring

### Done State

The MAX8900\_ enters its done state after the charger has been in the top-off state for  $t_{TO}$ . In this state, the switching charger is off and no current is delivered to the battery. Although the charger is off, the SETI and DNI pins are biased in the done state and the MAX8900\_ consumes the associated current from the battery ( $I_{BAT} = 1.5V/R_{SETI} + 1.5V/R_{DNI} + 3\mu A$ ). If the system load presented to the battery is low ( $\ll 100\mu A$ ), then a typical system can remain in the done state for many days. If left in the done state long enough, the battery voltage decays below the restart threshold ( $V_{RSTRT}$ ) and the MAX8900\_ transitions back into the fast-charge state. There is no soft-start (di/dt limiting) during the done-to-fast-charge state transition.

### Timer Fault State

The timer fault state occurs when either the prequalification or fast-charge timers expire, or SETI/DNI is shorted to ground (see the *Setting the Fast-Charge Current (SETI)* and *Setting the Prequalification Current and Done Threshold (DNI)* sections for more details). In this state the charger is off. The charger can exit the timer fault state by either cycling  $\overline{CEN}$  or input power.

### Battery Hot/Cold State

The battery hot/cold state occurs when the MAX8900\_ is in any of its charge states (dead battery, prequalification, fast-charge, top-off) and thermistor temperature is either less than  $T_1$  or greater than  $T_4$ . In this state, the charger is off and timers are suspended. The MAX8900\_ exits the temperature suspend state and returns to the state it came from once the thermistor temperature is greater than  $T_1$  and less than  $T_4$ . The timer resumes once the MAX8900\_ exits this state.

### V<sub>IN</sub> Too High State

The  $V_{IN}$  too high state occurs when the MAX8900\_ is in any of its charge states (dead battery, prequalification, fast-charge, top-off) and  $V_{IN}$  exceeds  $V_{OVLO}$ . In this state, the charger is off and timers are suspended. The MAX8900\_ exits the  $V_{IN}$  too high state and returns to the state it came from when  $V_{IN}$  decreases below  $V_{OVLO}$ . The timer resumes once the MAX8900\_ exits this state.

### Charge Timer (CT)

As shown in Figure 7, a fault timer prevents the battery from charging indefinitely. In the dead-battery, prequalification, and fast-charge states, the timer is controlled by the capacitance at CT ( $C_{CT}$ ). The MAX8900\_ supports values of  $C_{CT}$  from 0.01 $\mu F$  to 1.0 $\mu F$ . Calculate the prequalification time ( $t_{PQ}$ ) and fast-charge time ( $t_{FC}$ ) as follows (Figure 9):

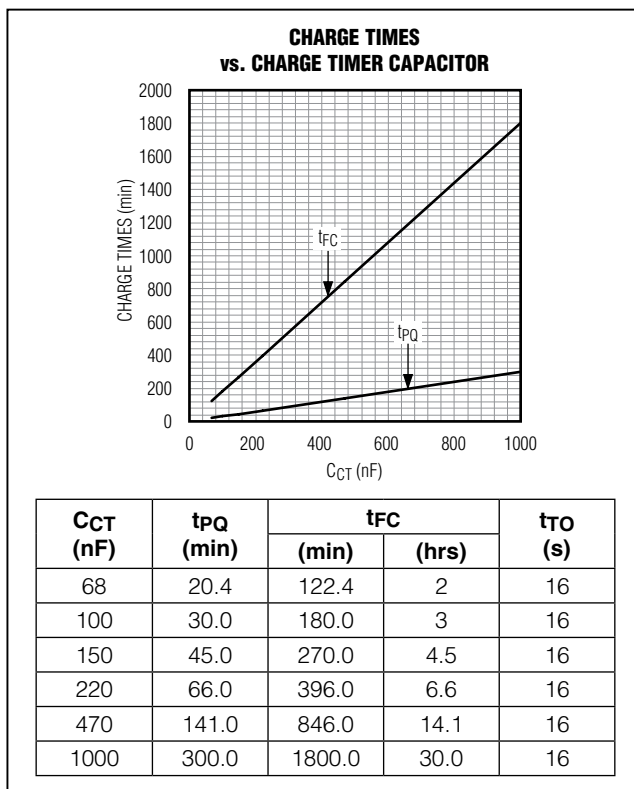

Figure 9. Charge Times vs.  $C_{CT}$

$$t_{PQ} = 30\text{min} \times \frac{C_{CT}}{0.1\mu F}$$

$$t_{FC} = 180\text{min} \times \frac{C_{CT}}{0.1\mu F}$$

The top-off time ( $t_{TO}$ ) is fixed at 16s:

$$t_{TO} = 16\text{s}$$

Connect CT to GND to disable the prequalification/dead-battery and fast-charge timers. With the internal timers of the MAX8900\_ disabled, an external device, such as a  $\mu P$  can control the charge time through the  $\overline{CEN}$  input.

### Thermal Management

The MAX8900\_ is packaged in a 2.44mm x 2.67mm x 0.64mm, 0.4mm pitch WLP package and withstands a junction temperature of +150°C. The MAX8900\_ is rated for the extended ambient temperature range from -40°C to +85°C. Table 1 and Application Note 1891: *Wafer-Level Packaging (WLP) and Its Applications* ([www.maximintegrated.com/ucsp](http://www.maximintegrated.com/ucsp)) show the thermal characteristics of this package. The MAX8900\_ uses

# MAX8900A/MAX8900B/MAX8900C

## 1.2A Switch-Mode Li+ Chargers with ±22V Input Rating and JEITA Battery Temperature Monitoring

**Table 1. 2.44mm x 2.67mm x 0.64mm, 0.4mm Pitch WLP Thermal Characteristics**

	<b>FOUR-LAYER PCB (JESD51-9:2s2p)</b>
Continuous Power Dissipation	1619mW Derate 20.2mW/°C above +70°C/W
$\theta_{JA}$	49.4°C/W
$\theta_{JC}$	9°C/W
Board Parameters	<ul style="list-style-type: none"> <li>• Still air</li> <li>• 4-layer board</li> <li>• 1.5oz copper on outer layers</li> <li>• 1oz copper on inner layers</li> <li>• 1.6mm thick board (62mil)</li> <li>• 4in x 4in board</li> <li>• Four center thermal vias</li> <li>• FR-4</li> </ul>

several thermal management techniques to prevent excessive battery and die temperatures.

### **Thermistor Monitor (THM)**

The MAX8900\_ adjusts the charge current and termination voltage as described in the JEITA specification for safe use of secondary Li+ batteries (*A Guide to the Safe Use of Secondary Lithium Ion Batteries in Notebook-type Personal Computers, April 20, 2007*). As shown in Figure 10, there are four temperature thresholds that change the battery charger operation: T1, T2, T3, and T4. When the thermistor input exceeds the extreme temperatures (< T1 or > T4), the charger shuts off and all respective charging timers are suspended. While the thermistor remains out of range, no charging occurs, and the timer counters hold their state. When the thermistor input comes back into range, the charge timers continue to count. The middle thresholds (T2 and T3) do not shut the charger off, but adjust the current/voltage targets to maximize charging while reducing battery stress. Between T3 and T4, the voltage target is reduced (see VBATREG in the *Electrical Characteristics* table); however, the charge timers continue to count. Between T1 and T2, the charging current target is reduced to 50% of its normal operating value; and similarly the charge timers continue to count.

If the thermistor functionality is not required, connect a 1MΩ resistor from THM to AVL and another 1MΩ resistor from THM to GND. This biases the THM node to be ½ of the AVL voltage telling the MAX8900\_ that the battery temperature is between the T2 and T3 temperature range. Furthermore, the high 2MΩ impedance presents a minimal load to AVL.

Table 2 shows that the MAX8900\_ is compatible with several standard thermistor values. When using a 10kΩ thermistor with a beta of 3380K, the configuration of Figure 11A provides for temperature trip thresholds that are very close to the nominal T1, T2, T3, and T4 (see the *Electrical Characteristics* table). When using alternate resistance and/or beta thermistors, the circuit of Figure 11A may result in temperature trip thresholds that are different from the nominal values. In this case, the circuit of Figure 11B allows for compensating the thermistor to shift the temperature trip thresholds back to the nominal value. In general, smaller values of RTP shift all the temperature trip thresholds down; however, the lower temperature thresholds are affected more than the higher temperature thresholds. Furthermore, larger values of RTS shift all the temperature trip thresholds up; however, the higher temperature thresholds are affected more than the lower temperature thresholds. For assistance with thermistor calculations, use the spreadsheet at the following link: [www.maximintegrated.com/tools/other/software/MAX8900-THERMISTOR.XLS](http://www.maximintegrated.com/tools/other/software/MAX8900-THERMISTOR.XLS)

The general relation of thermistor resistance to temperature is defined by the following equation:

$$R_{THRM} = R_{25} \times e^{\left( \beta \left( \frac{1}{T+273^{\circ}\text{C}} - \frac{1}{298^{\circ}\text{C}} \right) \right)}$$

where:

$R_{THRM}$  = The resistance in Ω of the thermistor at temperature T in Celsius.

$R_{25}$  = The resistance in Ω of the thermistor at  $T_A = +25^{\circ}\text{C}$ .

$\beta$  = The material constant of the thermistor, which typically ranges from 3000K to 5000K.

T = The temperature of the thermistor in °C.



# MAX8900A/MAX8900B/MAX8900C

## 1.2A Switch-Mode Li+ Chargers with ±22V Input Rating and JEITA Battery Temperature Monitoring

Table 2. Trip Temperatures for Different Thermistors

THERMISTOR	TEMPERATURE						
R <sub>THRM</sub> at T <sub>A</sub> = +25°C	10,000	10,000	10,000	47,000	47,000	100,000	100,000
Thermistor Beta (β[Ω])	3380	3940	3940	4050	4050	4250	4250
RTB (Ω)	10,000	10,000	10,000	47,000	47,000	100,000	100,000
RTP (Ω)	OPEN	OPEN	301,000	OPEN	1,200,000	OPEN	1,800,000
RTS (Ω)	SHORT	SHORT	499	SHORT	2,400	SHORT	6,800
Resistance at T1_n15 (Ω)	61,788	61,788	77,248	290,410	380,716	617,913	934,027
Resistance at T1_0 (Ω)	29,308	29,308	31,971	137,750	153,211	293,090	343,283
Resistance at T2 (Ω)	15,000	15,000	15,288	70,500	72,500	150,002	156,836
Resistance at T3 (Ω)	5,309	5,309	4,906	24,954	23,083	53,093	47,906
Resistance at T4 (Ω)	2,910	2,910	2,439	13,676	11,434	29,099	22,777
Temperature at T1_n15 (°C) [-15°C nom]	-16.2	-11.1	-14.9	-10.2	-14.8	-8.7	-15.4
Temperature at T1_0 (°C) [0°C nom]	-0.8	2.6	0.9	3.2	1.2	4.1	1.3
Temperature at T2 (°C) [+15°C nom]	14.7	16.1	15.7	16.4	15.8	16.8	15.9
Temperature at T3 (°C) [+45°C nom]	42.6	40.0	42.0	39.6	41.5	38.8	41.2
Temperature at T4 (°C) [+60°C nom]	61.4	55.7	60.6	54.8	59.6	53.2	59.2

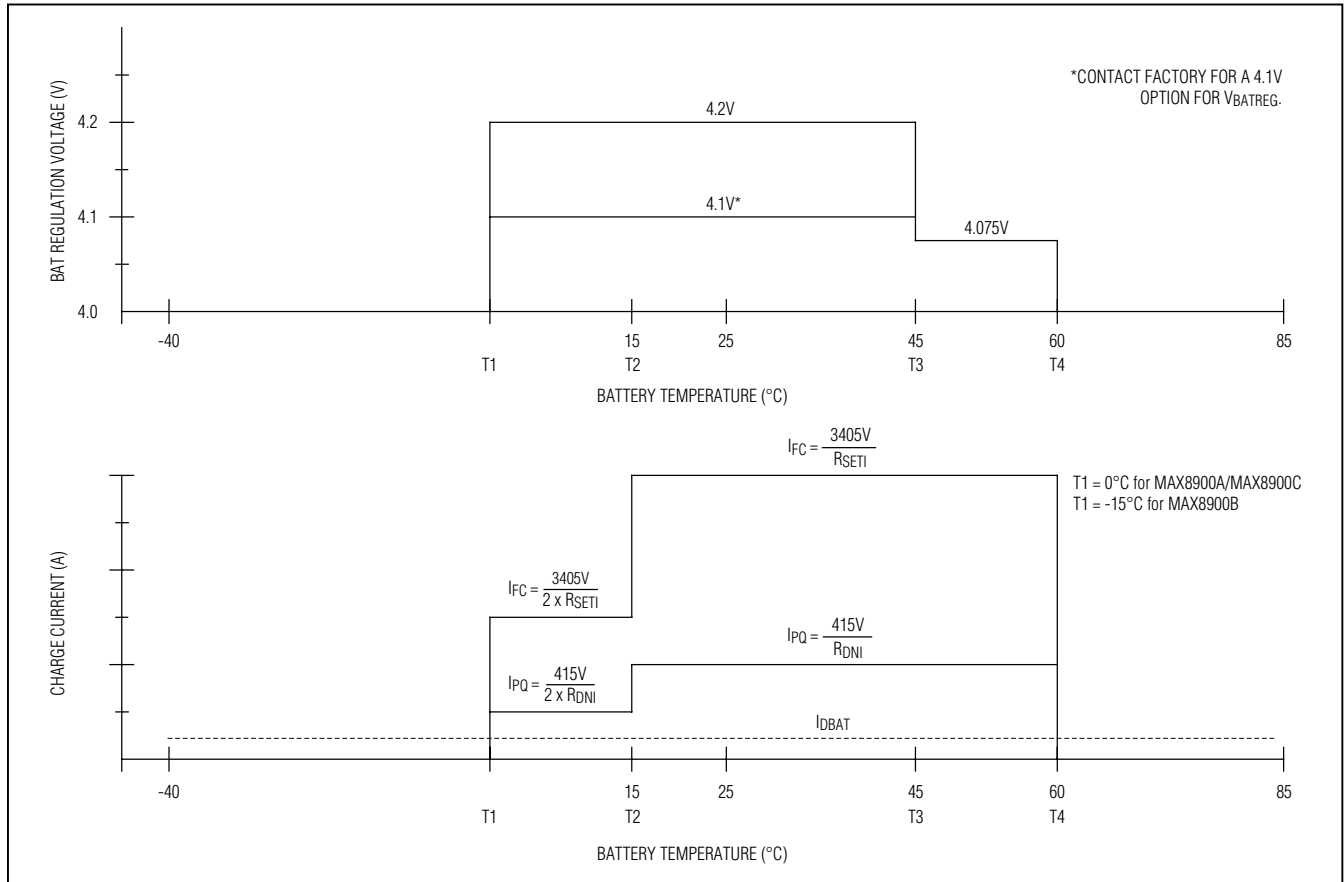

Figure 10. JEITA Battery Safety Regions

# MAX8900A/MAX8900B/MAX8900C

## 1.2A Switch-Mode Li+ Chargers with ±22V Input Rating and JEITA Battery Temperature Monitoring

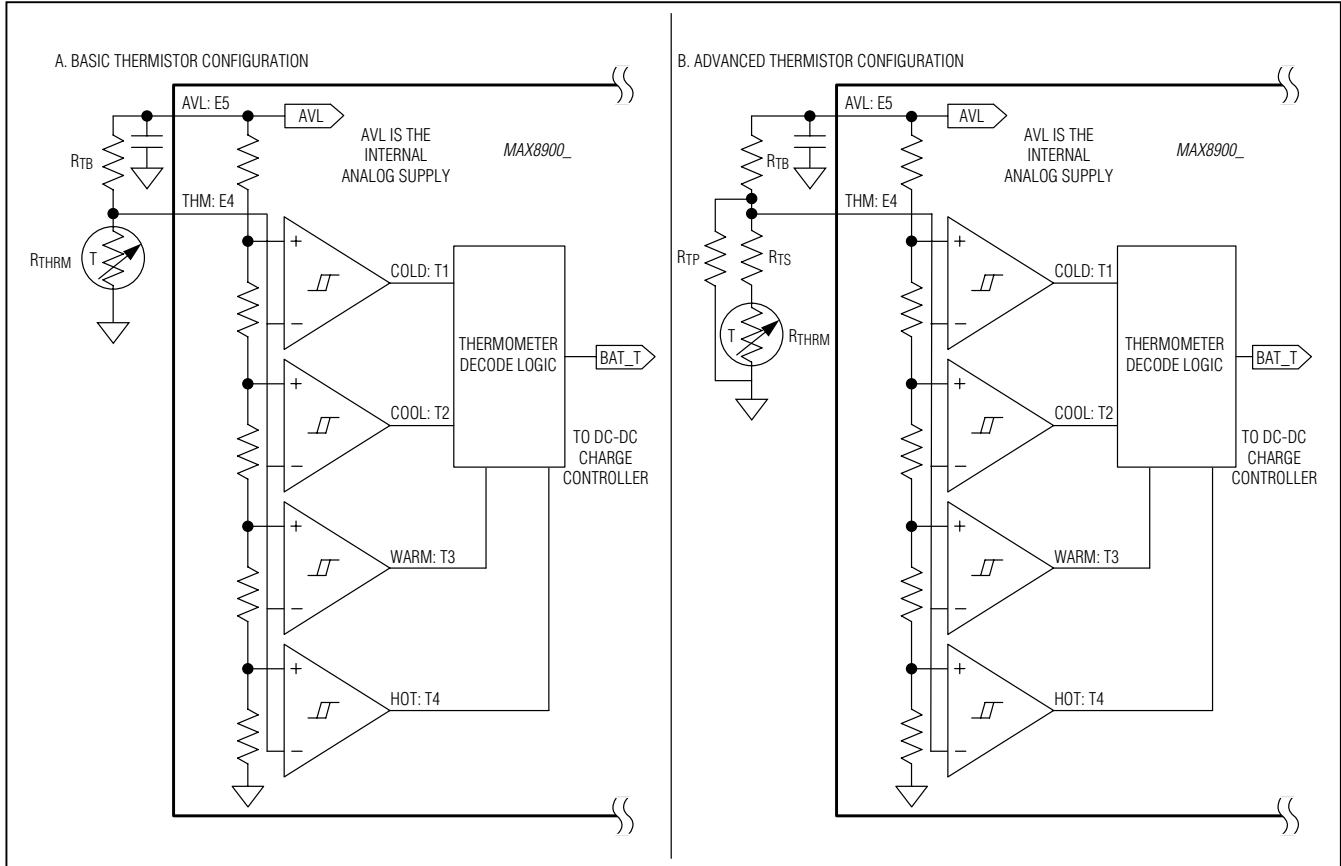

Figure 11. Thermistor Monitor Detail

### Thermal Foldback

Thermal foldback maximizes the battery charge current while regulating the MAX8900\_ junction temperature. As shown in Figure 12, when the die temperature exceeds  $T_{REG}$ , a thermal limiting circuit reduces the battery charge-current target by  $\Delta T_{REG}$ , until the charge current reaches 25% of the fast-charge current setting. The charger maintains 25% of the fast-charge current until the die temperature reaches  $T_{SHDN}$ . Please note that the MAX8900\_ is rated for a maximum ambient temperature of +85°C. Furthermore, although the maximum die temperature of the MAX8900\_ is +150°C, it is common industry practice to design systems in such a way that the die temperature never exceeds +125°C. Limiting the maximum die temperature to +125°C extends long-term reliability.

### Thermal Shutdown

As shown in Figure 12, when the MAX8900\_ die temperature exceeds  $T_{SHDN}$ , the IC goes into thermal shutdown.

During shutdown, the step-down charger is off and all internal blocks except the bias circuitry is turned off. Once the junction has cooled by 15°C, the IC resumes operation.

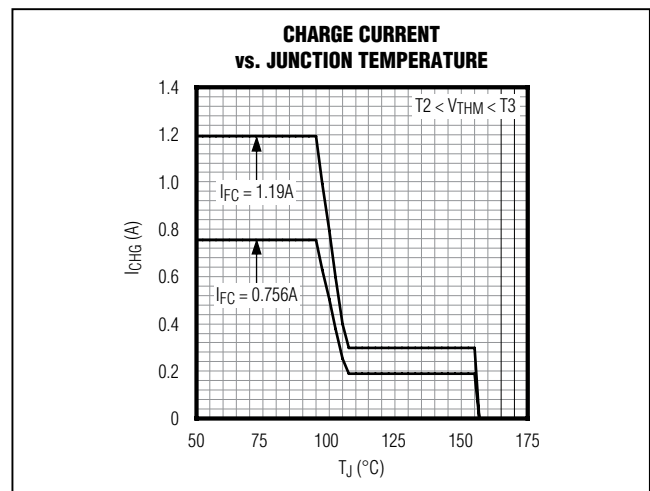

Figure 12. Charge Current vs. Junction Temperature

# MAX8900A/MAX8900B/MAX8900C

## 1.2A Switch-Mode Li+ Chargers with ±22V Input Rating and JEITA Battery Temperature Monitoring

### PVL and AVL Regulator

PVL is a 5V linear regulator that the MAX8900\_ uses to power the gate drivers for its step-down charger. PVL also charges the BST capacitor. The PVL linear regulator is on when  $\overline{CEN}$  is low,  $V_{IN}$  is greater than ~2V, and  $V_{IN}$  is above  $V_{BAT}$  by the  $V_{IN2BAT}$  threshold, otherwise it is off. Bypass PVL with a 1 $\mu$ F ceramic capacitor to GND. Powering external loads from PVL is not recommended.

As shown in Figure 3, AVL is a filtered output from the PVL linear regulator that the MAX8900\_ uses to power its internal analog circuits. The filter consists of an internal 12.5 $\Omega$  resistor and the AVL external bypass capacitor (0.1 $\mu$ F). This filter creates a 127kHz lowpass filter that cleans the 3.25MHz switching noise from the analog portions of the MAX8900\_. Connect a 0.1 $\mu$ F ceramic capacitor from AVL to GND. Powering external loads with AVL is not recommended.

### Charge Status Outputs (3 Pin)

STAT1, STAT2, and STAT3 are open-drain outputs that indicate the status of the MAX8900B/MAX8900C as shown in Table 3.

When the status outputs are used to communicate with a  $\mu$ P, pull them up to the system logic voltage ( $V_{LOGIC}$ ) to create a signal that has a logic-high and logic-low state that the  $\mu$ P can easily interpret (Figure 2). Since more than one status signal may change when the MAX8900B/MAX8900C changes states, the  $\mu$ P must implement a deglitching routine for the interpretation of the status signals.

**Table 3. 3-Pin Status Output Truth Table**

STAT1	STAT2	STAT3	INDICATION
0	0	0	Battery cold (THM < T1)
0	0	1	$V_{IN} > V_{OVLO}$
0	1	0	Charging (dead-battery state or dead battery + prequalification state or prequalification state or fast-charge state)
0	1	1	Battery hot (THM > T4)
1	0	0	Done state
1	0	1	Undefined. This state does not occur.
1	1	0	Timer fault
1	1	1	$V_{IN} < V_{UVLO}$ or $\overline{CEN} = 1$ or $V_{IN} < (V_{BAT} + V_{IN2BAT})$ or thermal shutdown

**Note:** STAT1, STAT2, and STAT3 are open-drain outputs. "0" indicates that the output device is pulling low. "1" indicates that the output is high impedance.

When the status outputs are used to drive LED indicators, a series resistor should limit the LED current to be less than 30mA (Figure 1). The STAT1 and STAT2 typical pull-down resistance is 25 $\Omega$  and the absolute maximum rating is +30V. This +30V rating allows IN to be used to bias STAT1 and STAT2. The STAT3 typical pulldown resistance is 10 $\Omega$  and the absolute maximum rating is +6V.

### Charge Status Outputs (2 Pin + > T4)

STAT1 and STAT2 are open-drain outputs that indicate the status of the MAX8900A as shown in Table 4.

When the status outputs are used to communicate with a  $\mu$ P, pull them up to the system logic voltage ( $V_{LOGIC}$ ) to create a signal that has a logic-high and logic-low state that the  $\mu$ P can easily interpret (Figure 2). Since more than one status signal may change when the MAX8900A changes states, the  $\mu$ P must implement a deglitching routine for the interpretation of the status signals.

When the status outputs are used to drive LED indicators, a series resistor should limit the LED current to be less than 30mA (Figure 1). Note that the STAT1 and STAT2 typical pulldown resistance is 25 $\Omega$  and the absolute maximum rating is +30V. This +30V rating allows IN to be used to bias STAT1 and STAT2.

STAT3 pulls low when the battery temperature monitor detects that the battery temperature is greater than the T4 threshold, otherwise, STAT3 is high impedance. Some systems may want to reduce the battery loading when STAT3 pulls low to prevent the battery from getting excessively hot.

**Table 4. 2-Pin Status Output Truth Table**

STAT1	STAT2	INDICATION
0	0	Undefined. This does not occur when the MAX8900_ is powered.
0	1	Charging (dead-battery state or dead battery + prequalification state or prequalification state or fast-charge state)
1	0	Timer fault or $V_{IN} > V_{OVLO}$ or battery cold (THM < T1) or battery hot (THM > T4)
1	1	Done state or $\overline{CEN} = 1$ or $V_{IN} < V_{UVLO}$ or $V_{IN} < (V_{BAT} + V_{IN2BAT})$ or thermal shutdown

**Note:** STAT1 and STAT2 are open-drain outputs. "0" indicates that the output device is pulling low. "1" indicates that the output is high impedance.

# MAX8900A/MAX8900B/MAX8900C

## 1.2A Switch-Mode Li+ Chargers with ±22V Input Rating and JEITA Battery Temperature Monitoring

### Inductor Selection

Consider inductance, current rating, series resistance, physical size, and cost when selecting an inductor. These factors affect the converter's efficiency, maximum output current, transient response time, and output voltage ripple. Tables 5 and 6 show suggested inductor values based upon input voltage and laboratory tests.

When using the MAX8900\_ with IN voltages below 8.5V, select the inductor to be 1.0μH. This keeps the inductor peak-to-peak ripple current to the average DC inductor current at the full load (LIR) between 40% to 50%. If a lower ripple is desired, select an inductance from 2.2μH

to 10μH. Higher input voltages require higher inductors to maintain the same inductor current ripple.

The trade-off between inductor size and converter efficiency for step-down regulators varies as the LIR varies. LIR is the ratio of the inductor peak-to-peak ripple current to the average DC inductor current at the full-load current. A higher LIR value allows for smaller inductance, but result in higher losses and higher output voltage ripple. To reduce the power dissipation and improve transient response, choose an inductor that has a low DC series resistance as well as a low AC resistance at 3.25MHz.

Note that it is typical for low inductance inductors such as 1μH to have a ±30% initial variation in inductance. Furthermore, some physically smaller inductors show a substantial degradation in inductance with increased DC current. It is typical for inductor manufacturers to specify their saturation current at the level when the initial inductance decreases by 30% or at the level where the internal inductor temperature rises +40°C above the ambient temperature. Because of differences in the way inductor manufacturers specify saturation current (ISAT), it is critical that you study and understand your manufacturer's specification criteria.

**Table 5. Recommended Inductor Selection**

DC INPUT VOLTAGE RANGE (V)	RECOMMENDED INDUCTOR FOR 40% LIR
3.4 to 8.7	1μH inductor, LQM2HPN1R0G0, Murata, 2.5mm x 2.0mm x 0.9mm, 55mΩ, 1.6A.
8.7 to 15.8	1.5μH inductor, LQM2HPN1R5G0, Murata, 2.5mm x 2.0mm x 0.9mm, 70mΩ, 1.5A
15.8 to 27.4	2.2μH inductor, LQM2HPN2R2G0, Murata, 2.5mm x 2.0mm x 0.9mm, 80mΩ, 1.3A.

**Table 6. Recommended Inductor**

MANUFACTURER	SERIES	INDUCTANCE (μH)	ESR (Ω)	CURRENT RATINGS (A)	DIMENSIONS
Coilcraft	EPL2014	1.0	0.059	1.68	2.0 x 2.0 x 1.4 = 5.6mm <sup>3</sup>
		1.5	0.075	1.60	
		2.2	0.120	1.30	
Murata	LQM2MPN_G0	1.0	0.085	1.40	2.0 x 1.6 x 0.9 = 2.88mm <sup>3</sup>
		1.5	0.110	1.20	
		2.2	0.110	1.20	
		3.3	0.120	1.20	
	LQM2HPN_G0	1.0	0.055	1.60	2.5 x 2.0 x 0.9 = 4.5mm <sup>3</sup>
		1.5	0.070	1.50	
		2.2	0.080	1.30	
TDK	MLP2520S	1.0	0.060	1.50	2.0 x 2.5 x 1.0 = 5mm <sup>3</sup>
		1.5	0.070	1.50	
	CPL2512	1.0	0.090	1.20	2.5 x 1.5 x 1.2 = 3.6mm <sup>3</sup>
		2.2	0.135	0.90	
TOKO	MDT2520-CH	1.0	0.110	1.20	2.5 x 2.0 x 1.0 = 5mm <sup>3</sup>
		1.5	0.140	1.10	
		2.2	0.16	1.05	
	MDT2520-CN	1.0	0.085	1.35	2.5 x 2.0 x 1.2 = 6mm <sup>3</sup>
		1.5	0.095	1.25	
		2.2	0.105	1.20	
		3.3	0.115	1.15	

# MAX8900A/MAX8900B/MAX8900C

## 1.2A Switch-Mode Li+ Chargers with ±22V Input Rating and JEITA Battery Temperature Monitoring

If the input voltage approaches the BAT voltage during fast-charge constant current state, the maximum current is no longer limited by the current loop, but by the dropout resistance. The total dropout resistance is:

$$R_{\text{DROPOUT}} = R_{\text{IN2INBP}} + R_{\text{HS}} + R_{\text{L}} + R_{\text{SNS}} = 0.120\Omega + 0.100\Omega + R_{\text{L}} + 0.040\Omega$$

$R_{\text{DROPOUT}}$  heavily depends upon the inductor ESR ( $R_{\text{L}}$ ). A low  $R_{\text{L}}$  is required to maximize performance.

### BAT Capacitor

Choose the nominal BAT capacitance to be 2.2μF. The BAT capacitor is required to keep the BAT voltage ripple small and to ensure regulation loop stability. The BAT capacitor must have low impedance at the switching frequency. Ceramic capacitors with X5R or X7R dielectric are highly recommended due to their small size, low ESR, and small temperature coefficients. For optimum load-transient performance and very low output voltage ripple, the BAT capacitor value can be increased above 2.2μF.

As the case sizes of ceramic surface-mount capacitors decreases, their capacitance vs. DC bias voltage characteristic becomes poor. Due to this characteristic, it is possible for 0603 capacitors to perform well while 0402 capacitors of the same value perform poorly. The MAX8900\_ require a nominal BAT capacitance of 2.2μF, however, after initial tolerance, bias voltage, aging, and temperature derating, the capacitance must be greater than 1.5μF. With the capacitor technology that is available at the time the MAX8900\_ was released to production, the BAT capacitance is best achieved with a single ceramic capacitor (X5R or X7R) in an 0603 or 0805 case size. The capacitor voltage ratings should be 6.3V or greater.

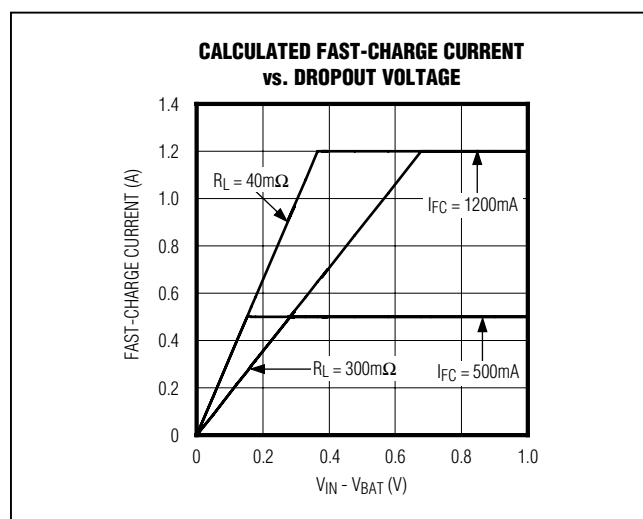

Figure 13. Calculated Fast-Charge Current vs. Dropout Voltage

### INBP Capacitor

Choose the INBP capacitance ( $C_{\text{INBP}}$ ) to be 0.47μF. Larger values of  $C_{\text{INBP}}$  improve the decoupling for the DC-DC step-down converter, but they cause a larger IN to INBP inrush current when the input adapter is connected. To limit the IN inrush current ( $I_{\text{IN}}$ ) to the 2.4A maximum (see the *Absolute Maximum Ratings* section), limit  $C_{\text{INBP}}$  by the maximum input voltage slew rate ( $V_{\text{INSR}}$ ) on IN:  $C_{\text{INBP}} < 2.4\text{A}/V_{\text{INSR}}$ .

$C_{\text{INBP}}$  reduces the current peaks drawn from the battery or input power source during switch-mode operation and reduces switching noise in the MAX8900\_. The impedance of the input capacitor at the switching frequency should be very low. Ceramic capacitors with X5R or X7R dielectric are highly recommended due to their small size, low ESR, and small temperature coefficients. For optimum noise immunity and low input voltage ripple, the input capacitor value can be increased. To fully utilize the ±22V input capability of the MAX8900\_, the INBP capacitor voltage rating must be 25V or greater. Note that if  $V_{\text{IN}}$  falls below  $V_{\text{BAT}}$ ,  $V_{\text{INBP}}$  remains at the  $V_{\text{BAT}}$  potential (i.e., a -20V at IN does not pull down INBP). Because  $V_{\text{INBP}}$  never goes negative, it is possible to use a polarized capacitor (Maxim recommends a ceramic capacitor).

INBP is a critical discontinuous current path that requires careful bypassing. In the PCB layout, place  $C_{\text{INBP}}$  as close as possible to the power pins (INBP and PGND) to minimize parasitic inductance. If making connections to the INBP capacitor through vias, ensure that the vias are rated for the expected input current so they do not contribute excess inductance and resistance between the bypass capacitor and the power pins. The expected INBP current is the same as the  $I_{\text{SAT}}$  (see the *Inductor Selection* section). See the *PCB Layout* section for more details.

The input capacitor must meet the input ripple current requirement imposed by the step-down converter. Ceramic capacitors are preferred due to their low ESR and resilience to surge currents. Choose the INBP capacitor so that its temperature rise due to ripple-current does not exceed approximately  $T_{\text{A}} = +10^{\circ}\text{C}$ . For a step-down regulator, the maximum input ripple current is half of the output current. This maximum input ripple current occurs when the step-down converter operates as 50% duty cycle ( $V_{\text{IN}} = 2 \times V_{\text{BAT}}$ ).

### Other Capacitors

The minimum IN capacitor ( $C_{\text{IN}}$ ) is 0.47μF with a voltage rating of 25V or greater. Note that although the MAX8900\_ needs only 0.47μF, larger capacitors can be used. Some specifications from USB-IF require a 2.2μF capacitor to have proper handshaking during OTG operation. The BST

# MAX8900A/MAX8900B/MAX8900C

## 1.2A Switch-Mode Li+ Chargers with ±22V Input Rating and JEITA Battery Temperature Monitoring

capacitor (CBST) is a 0.1µF with a voltage rating of 10V or greater. If CBST is increased then maintain a ratio of less than 1:10 between CBST and CPVL. CBST stores charge to drive the high-side n-channel gate. The minimum AVL capacitor is 0.1µF with a voltage rating of 6.3V. The minimum PVL capacitor is 1.0µF with a voltage rating of 6.3V. Ceramic capacitors with X5R or X7R dielectric are highly recommended due to their small size, low ESR, and small temperature coefficients.

### Applications Information

#### Dynamic Charge Current Programming

Certain applications require dynamic programming of the charge current. For example, if the input supply is a USB source, then the system might need to adjust the charge current to support the 100mA and 500mA input current ratings dictated by the USB-IF. Figure 2 illustrates one approach to dynamically program the charge current. By driving the gates of two MOSFET switches to logic-high or logic-low, a microprocessor (µP) connects or disconnects different program resistors. This method allows for four different charge current values ranging from 95mA to 1187mA. When a MOSFET is turned on, its associated resistor is connected to SET1. As resistors are added in parallel, the total resistance from SET1 to ground decreases, which causes IFC to increase.

In the particular example of a USB input, the circuit of Figure 2 could be leveraged as follows: When a VBUS connect event is detected, the µP can immediately initiate the USB 100mA current mode by setting GPIO[6:4] = 0b000. After the USB transceiver has enumerated with 500mA permission, the µP can initiate the USB 500mA current mode by setting GPIO[6:4] = 0b010. If the USB transceiver detects that a USB suspend is needed, then the µP can reduce the input current to 40µA by setting GPIO[6:4] = 0b001. Alternatively, it is possible that after the VBUS connect event that the USB transceiver determines that there is a dedicated USB wall charger (D+ and D- shorted together) and then the µP can set the charge current to the full capability of the MAX8900\_ (1.2A) by setting GPIO[6:4] = 0b110.

#### No-Battery Operation

No-battery operation may be necessary in the application and/or end-of-line testing during production. The MAX8900\_ can operate a system without a battery as long as the following conditions are satisfied:

- The system must not draw load currents that are greater than IFC.

- The system must not draw load currents that are greater than IPQ when the battery is less than VPQUTH.
- The thermistor node (THM) must be satisfied. Note that if the thermistor is in the battery pack and the pack is removed, the MAX8900\_ THM node voltage goes high and disables the charger. If the MAX8900\_ is expected to deliver charge without a battery then VTHM must be forced to AVL/2.
- The battery node should have enough capacitance to hold the battery voltage to some minimum acceptable system value (VSYRST) during the done-to-fast-charge state transition time of 100µs (tDONE2FC).

$$C_{BAT} \geq I_{LOAD} \times \frac{t_{DONE2FC}}{V_{BATREG} - V_{SYRST}}$$

For example, if the maximum system load without a battery could be 300mA (ILOAD) and the minimum acceptable system voltage is 3.4V (VSYRST), then the battery node should have at least 37.5µF.

$$C_{BAT} \geq 300mA \times \frac{100\mu s}{4.2V - 3.4V} = 37.5\mu F$$

#### Charge-Source Issues

A battery charger's input is typically very accessible to the end-user (i.e., available on a connector) and can potentially be exposed to very harsh conditions. The MAX8900\_ provides for high-reliability solution that can survive harsh conditions seen on its input.

#### Charge-Source Impedance

Charge source impedance can vary due to quality of the charge source and the associated connectors. The MAX8900\_ operates very nicely with input impedance up to 1Ω. When high input impedances cause the input voltage to drop, the MAX8900\_ simply reduces the charge current to a sustainable level and tries to put as much energy into the battery as possible. If the input voltage falls within the VIN2BAT threshold of the battery voltage, the MAX8900\_ shuts down to prevent any current flowing from the battery back to the charger source. The MAX8900\_ does not suffer from the self-oscillation problems that plague other chargers when exposed to high-impedance sources.

#### Inductive Kick

Often the input source has long leads connecting to the MAX8900\_, which, during connection and disconnect, can cause voltage spikes. The lead inductance and the input capacitor create an LC tank circuit. In the event that the LC tank circuit has a high Q (i.e., low series

# MAX8900A/MAX8900B/MAX8900C

## 1.2A Switch-Mode Li+ Chargers with ±22V Input Rating and JEITA Battery Temperature Monitoring

impedance), the voltage spike could be twice that of the nominal source voltage. In other words, a 6V source with a high-Q LC tank circuit in the cabling can result in a voltage spike as high as 12V. The MAX8900\_'s high input absolute maximum voltage rating of +22V to -22V eliminates any concerns about the voltage spikes due to inductive kicking for many applications.

In the event that an application may see a high-Q LC tank circuit in the cabling for a supply that is > +11V, a resistor ( $R_{IN}$ ) must be added in series with  $C_{IN}$  to reduce the Q of the tank circuit. The resistor value can be found experimentally by assuming the parasitic inductance ( $L_{PAR}$ ) of the input cabling is 1μH/m, then use the following equation give a good starting value for  $R_{IN}$ :

$$R_{IN} = 2 \times \sqrt{\frac{L_{PAR}}{C_{IN}}}$$

An alternative method for estimating  $L_{PAR}$  is to measure the frequency of the input voltage spike ringing and then calculate  $L_{PAR}$  from the following equation.

$$L_{PAR} = \frac{1}{(2 \times \pi \times f_R) \times C_{IN}}$$

### Overvoltage and Reverse Input Voltage Protection

The MAX8900\_ provides for a +22V absolute maximum positive input voltage and a -22V absolute maximum negative input voltage. Excursions to the absolute maximum voltage levels should be on a transient basis only, but can be withstood by the MAX8900\_ indefinitely.

Situations that typically require extended input voltage ratings include but are not limited to the following:

- Inductive kick
- Charge source failure
- Power surge
- Improperly wired wall adapter
- Improperly set universal wall adapter
- Wall adapter with the correct plug, but wrong voltage
- Home-built computer with USB wiring harness connected backwards (negative voltage)
- USB connector failure

- Excessive ripple voltage on a switch-mode wall charger
- USB powered hub that is powered by a wall charger (typically through a barrel connector) that has any of the aforementioned issues
- Unregulated charger (passively regulated by the turns ratio of the magnetic's turns ratio)

### PCB Layout

The MAX8900\_ WLP package and bump configuration allows for a small-size low-cost PCB design. Figures 3 and 14 show that the MAX8900\_ package's 30 bumps are combined into 18 functional nodes. The bump configuration places all like nodes adjacent to each other to minimize the area required for routing. The bump configuration also allows for a layout that does not use any vias within the WLP bump matrix (i.e., no micro vias). To utilize this no via layout,  $\overline{CEN}$  is left unconnected and the STAT3 pin is not used (2-pin status version).

Figure 15 shows the recommended land pattern for the MAX8900\_. Figure 16 shows the cross section of the MAX8900\_'s bump with detail of the under-bump metal (UBM). The diameter of each pad in the land pattern is close to the diameter of the UBM. This land pattern to UBM relationship is important to get the proper reflow of each solder bump.

Underfill is not necessary for the MAX8900\_'s package to pass the JESD22-B111 Board Level Drop Test Method for Handheld Electronic Products. JESD22-B111 covers end applications such as cell phones, PDAs, cameras, and other products that are more prone to being dropped during their lifetime due to their size and weight. Please consider using underfill for applications that require higher reliability than what is covered in the JESD22-B111 standard.

Careful printed circuit layout is important for minimizing ground bounce and noise. Figure 14 is an example layout of the critical power components for the MAX8900\_. The arrangement of the components that are not shown in Figure 14 is less critical. Refer to the MAX8900 Evaluation Kit for a complete PCB layout example. Use the following list of guidelines in addition to Application Note 1891: *Wafer-Level Packaging (WLP) and Its Applications* ([www.maximintegrated.com/ucsp](http://www.maximintegrated.com/ucsp)) to layout the MAX8900\_ PCB.

# MAX8900A/MAX8900B/MAX8900C

## 1.2A Switch-Mode Li+ Chargers with $\pm 22V$ Input Rating and JEITA Battery Temperature Monitoring

The guidelines at the top are the most critical:

- 1) When the step-down converter's high-side MOSFET turns on,  $C_{INBP}$  delivers a high  $di/dt$  current pulse to INBP. Because of this high  $di/dt$  current pulse, place  $C_{INBP}$  close to INBP to minimize the parasitic impedance in the PCB trace.
- 2) When the step-down converter is increasing the current in the inductor, the high-side MOSFET is on and current flows in the following path: from  $C_{INBP}$  into INBP >> out of LX >> through the inductor >> into CS >> out of BAT >> through  $C_{BAT}$  and back to  $C_{INBP}$  through the ground plane. This current loop should be kept small and the electrical length from the positive terminal of  $C_{INBP}$  to INBP should be kept short to minimize parasitic impedance. The electrical length from the negative terminal of  $C_{BAT}$  to the negative terminal of  $C_{INBP}$  should be short to minimize parasitic impedance. Keep all sensitive signals such as feedback nodes or audio lines outside of this current loop with as much isolation as your design allows.
- 3) When the step-down converter is decreasing the inductor current, the low-side MOSFET is on and the current flows in the following path: out of LX >> through the inductor >> into CS >> out of BAT >> through  $C_{BAT}$  >> into PGND >> out of LX again. This current loop should be kept small and the electrical length from the negative terminal of  $C_{BAT}$  to PGND should be short to minimize parasitic impedance. Keep all sensitive signals such as feedback nodes or audio lines outside of this current loop with as much isolation as your design allows.
- 4) The LX node voltage switches between INBP and PGND during the operation of the step-down converter. Minimize the stray capacitance on the LX node to maintain good efficiency. Also, keep all sensitive signals such as feedback nodes or audio lines away from LX with as much isolation as your design allows.
- 5) In Figure 14, the CS node is connected to the second layer of metal with vias. Use low-impedance vias that are capable of handling 1.5A of current. Also, keep the routing inductor current path on layer 2 just underneath the inductor current path on layer 1 to minimize impedance.

- 6) Both  $C_{BST}$  and  $C_{PVL}$  deliver current pulses for the MAX8900's MOSFET drivers. These components should be placed as shown in Figure 14 to minimize parasitic impedance.
- 7) Each of the MAX8900\_ bumps has approximately the same ability to remove heat from the die. Connect as much metal as possible to each bump to minimize the  $\theta_{JA}$  associated with the MAX8900\_. See the *Thermal Management* section for more information on  $\theta_{JA}$ .

In Figure 14, many of the top layer bump pads are connected together in top metal. When connecting bumps together with top layer metal, the solder mask must define the pads from  $180\mu m$  to  $210\mu m$  as shown in Figure 15. When using solder mask defined pads, please double check the solder mask openings on the PCB Gerber files before ordering boards as some PCB layout tools have configuration settings that automatically oversize solder mask openings. Also, explain in the PCB fabrication notes that the solder mask is not to be modified. Occasionally, optimization tools are used at the PCB fabrication house that modify solder masks. Layouts that do not use solder mask defined pads are possible. When using these layouts, adhere to the recommendations A through G above.

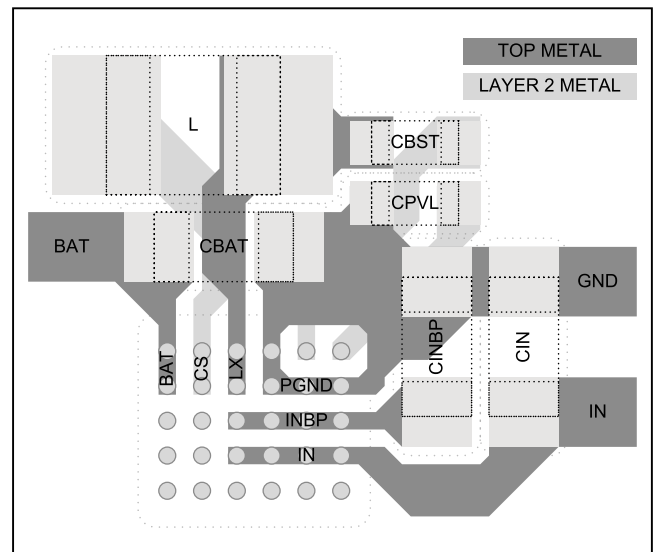

Figure 14. Power PCB Layout Example



# MAX8900A/MAX8900B/MAX8900C

## 1.2A Switch-Mode Li+ Chargers with ±22V Input Rating and JEITA Battery Temperature Monitoring

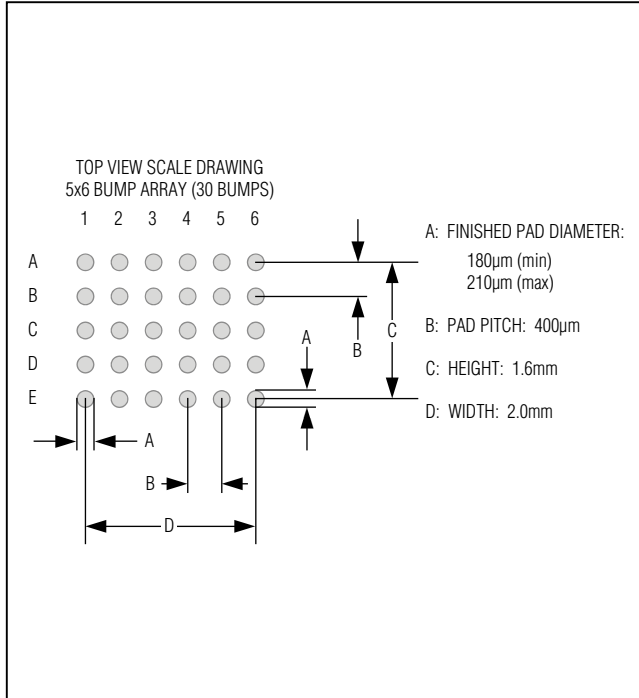

Figure 15. Recommended Land Pattern

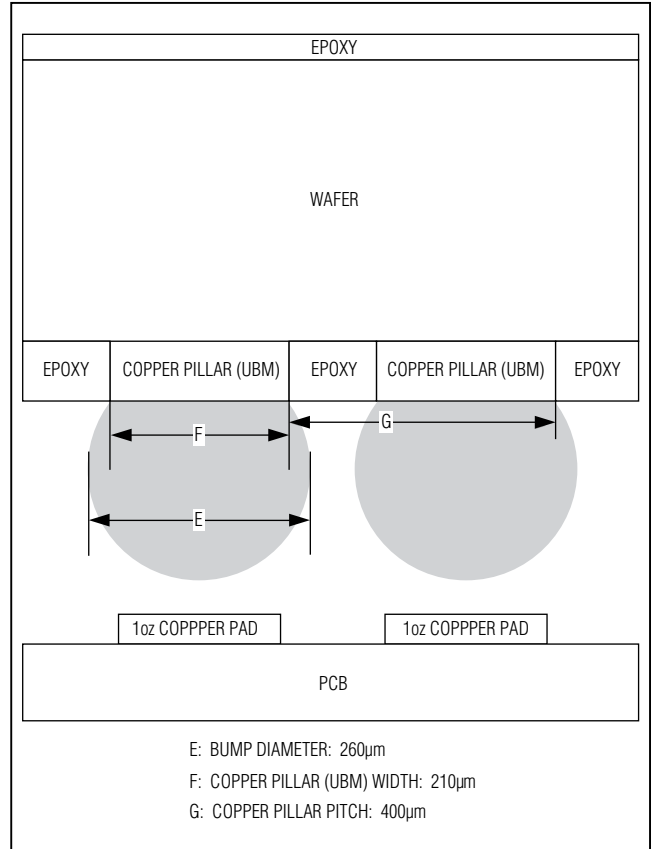

Figure 16. Bump Cross Section and Copper Pillar Detail

### Ordering Information (continued)

PART	TEMP RANGE	PIN-PACKAGE	OPTIONS
MAX8900CEWV+T	-40°C to +85°C	30 WLP	V <sub>OVLO</sub> = 6.5V T <sub>1</sub> = 0°C 3-pin status indicators V <sub>PQUTH</sub> = 3.0V

+Denotes a lead(Pb)-free/RoHS-compliant package.  
T = Tape and reel.

### Chip Information

PROCESS: BiCMOS

# MAX8900A/MAX8900B/MAX8900C

## 1.2A Switch-Mode Li+ Chargers with ±22V Input Rating and JEITA Battery Temperature Monitoring

### Package Information

For the latest package outline information and land patterns, go to [www.maximintegrated.com/packages](http://www.maximintegrated.com/packages). Note that a "+", "#", or "-" in the package code indicates RoHS status only. Package drawings may show a different suffix character, but the drawing pertains to the package regardless of RoHS status.

PACKAGE TYPE	PACKAGE CODE	OUTLINE NO.	LAND PATTERN NO.
30 WLP	W302A2+1	<a href="#">21-0211</a>	Refer to <a href="#">Application Note 1891</a>

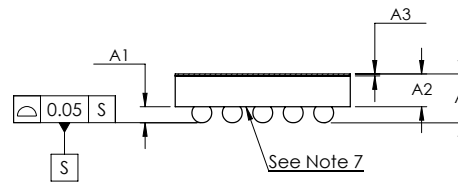
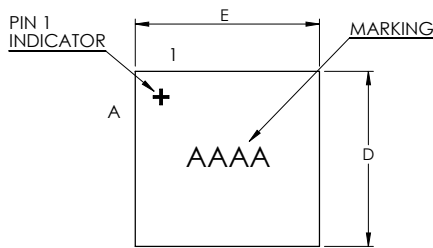

COMMON DIMENSIONS	
A	0.64 ±0.05
A1	0.21 ±0.03
A2	0.43 REF
A3	0.025 BASIC
b	∅0.26 ±0.03
D1	1.60 BASIC
E1	2.00 BASIC
e	0.40 BASIC
SD	0.00 BASIC
SE	0.20 BASIC

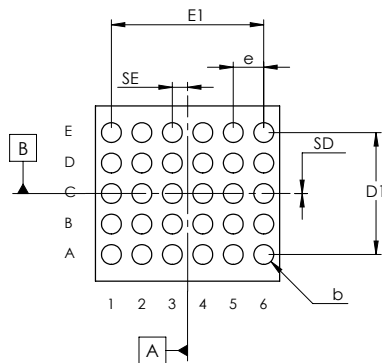

PKG. CODE	E		D		DEPOPULATED BUMPS
	MIN	MAX	MIN	MAX	
W302A2+1	2.61	2.73	2.31	2.44	NONE
W302A2+2	2.36	2.57	1.96	2.16	NONE
W302A2+3	2.57	2.77	2.16	2.36	NONE

- NOTES:
1. Terminal pitch is defined by terminal center to center value.
  2. Outer dimension is defined by center lines between scribe lines.
  3. All dimensions in millimeter.
  4. Marking shown is for package orientation reference only.
  5. Tolerance is ± 0.02 unless specified otherwise.
  6. All dimensions apply to PbFree (+) package codes only.
  7. Front - side finish can be either Black or Clear.

-DRAWING NOT TO SCALE-

TITLE			
PACKAGE OUTLINE 30 BUMPS, WLP PKG. 0.4mm PITCH			
APPROVAL	DOCUMENT CONTROL NO.	REV.	1/1
	21-0211	E	

# MAX8900A/MAX8900B/MAX8900C

## 1.2A Switch-Mode Li+ Chargers with $\pm 22V$ Input Rating and JEITA Battery Temperature Monitoring

### Revision History

REVISION NUMBER	REVISION DATE	DESCRIPTION	PAGES CHANGED
0	1/10	Initial release	—
1	3/10	Corrected various items	1, 4, 5, 15, 30
2	8/10	Updated Figures 2, 3, 7, and 8 and related text to indicate the charge timer applies to the dead-battery state and corrected other various errors	6, 14, 15, 16, 20–22, 27, 31
3	1/11	Added MAX8900C to data sheet	1–35
4	11/14	Removed automotive reference	31



Maxim Integrated cannot assume responsibility for use of any circuitry other than circuitry entirely embodied in a Maxim Integrated product. No circuit patent licenses are implied. Maxim Integrated reserves the right to change the circuitry and specifications without notice at any time. The parametric values (min and max limits) shown in the Electrical Characteristics table are guaranteed. Other parametric values quoted in this data sheet are provided for guidance.

# Mouser Electronics

Authorized Distributor

Click to View Pricing, Inventory, Delivery & Lifecycle Information:

[Maxim Integrated:](#)

[MAX8900CEWV+T](#) [MAX8900AEWV+T](#) [MAX8900BEWV+T](#)