

CPDQR5V0-HF

RoHS Device

Halogen Free

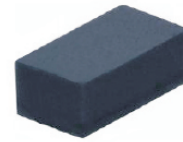

Features

- Surface mount package.
- IEC61000-4-2 Level 4 ESD protection.
- Ultra small SMD package:0402.
- High component density.

Mechanical data

- Case: 0402/SOD-923F standard package, molded plastic.
- Terminals: Gold plated, solderable per MIL-STD-750,method 2026.
- Marking Code:
CPDQR5V0-HF: E5
- Mounting position: Any.
- Weight: 0.001 grams(approx.).

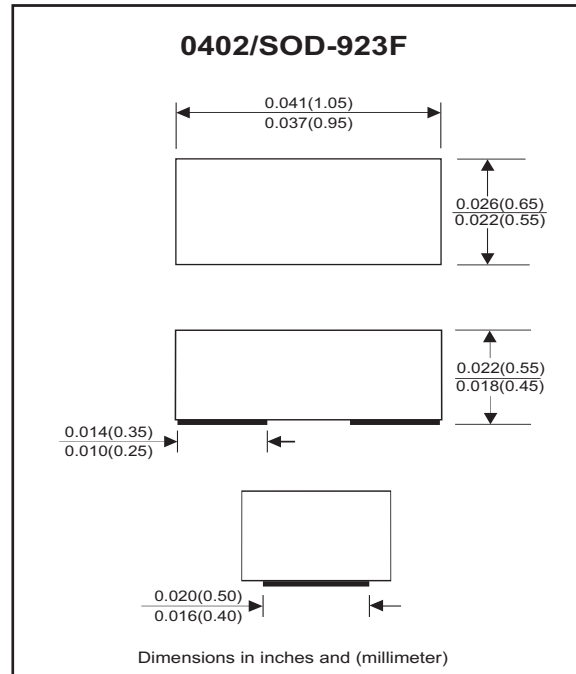

Circuit Diagram



Electrical Characteristics (at TA=25°C unless otherwise noted)

Parameter	Conditions	Symbol	Min	Typ	Max	Unit
Reverse stand-Off voltage		VRWM			5	V
Diode breakdown voltage	IR = 1mA	VBD	5.1	7		V
Leakage current	VR = 5V	IL		0.1	2	uA
Junction capacitance	VR = 0V, f = 1MHz	CT		15	20	pF
ESD capability	IEC 61000-4-2(air)	ESD			16	kV
	IEC 61000-4-2(contact)	ESD			8	kV
Clamping voltage	I _{PP} = 1A, T _P = 8/20us	V _C			10	V
	I _{PP} = 5A, T _P = 8/20us	V _C			15	V
Peak pulse power	T _P = 8/20us	P _{PP}			75	W
Operation temperature range		T _j	-55		125	°C
Storage temperature range		T _{STG}	-55		150	°C

RATING AND CHARACTERISTIC CURVES (CPDQR5V0-HF)

Fig.1 - 8/20us Peak Pulse Current Wave Form Acc. IEC 61000-4-5

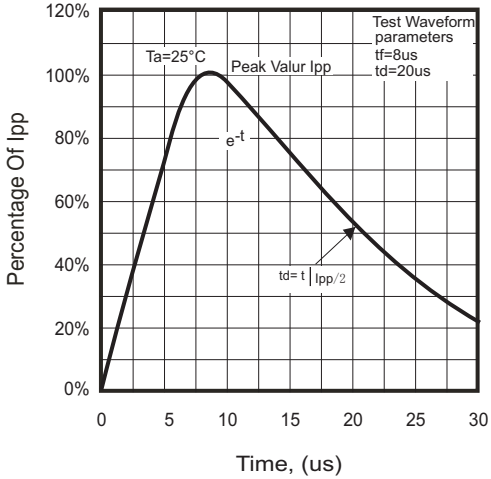

Fig.2 - Reverse characteristics

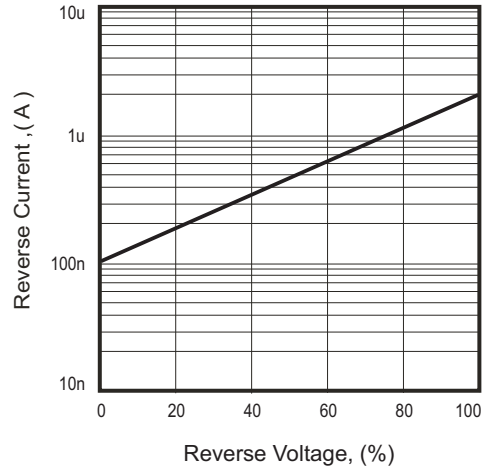

Fig.3 - Capacitance Between Terminals Characteristics

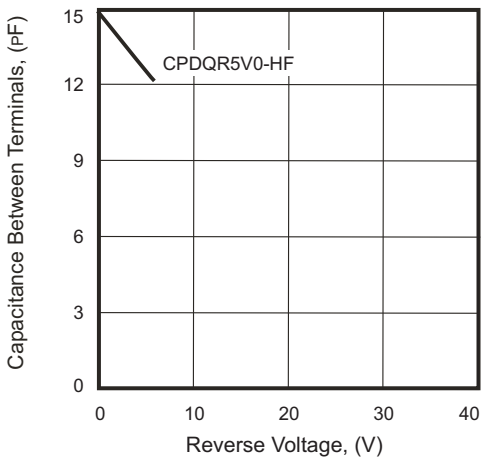
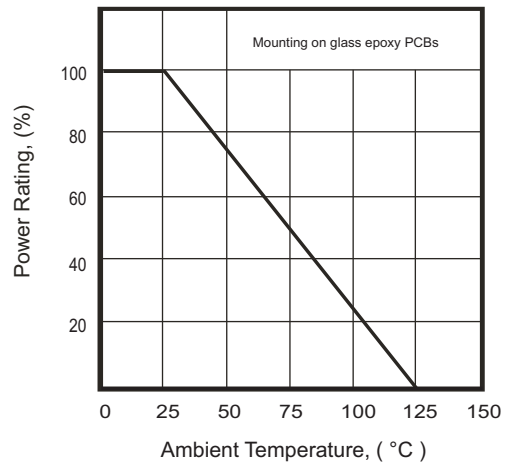
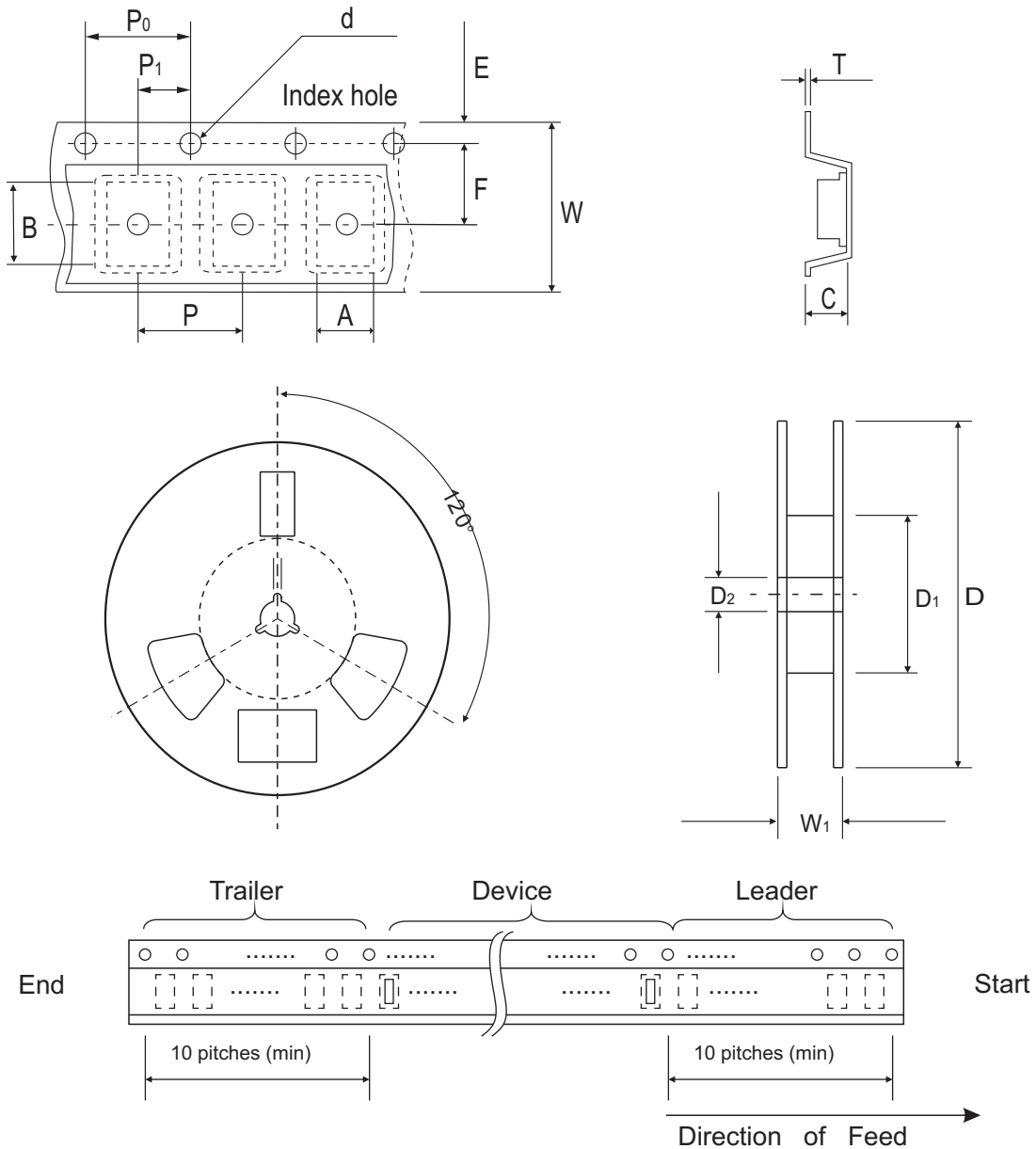

Fig.4 - Power Rating Derating Curve



Reel Taping Specification



0402 (SOD-923F)	SYMBOL	A	B	C	d	D	D ₁	D ₂
	(mm)	0.75 ± 0.10	1.15 ± 0.10	0.60 ± 0.10	1.55 ± 0.10	178 ± 1	60.0 MIN.	13.0 ± 0.20
	(inch)	0.030 ± 0.004	0.045 ± 0.004	0.024 ± 0.004	0.061 ± 0.004	7.008 ± 0.040	2.362 MIN.	0.512 ± 0.008

0402 (SOD-923F)	SYMBOL	E	F	P	P ₀	P ₁	T	W	W ₁
	(mm)	1.75 ± 0.10	3.50 ± 0.05	4.00 ± 0.10	4.00 ± 0.10	2.00 ± 0.10	0.22 ± 0.05	8.00 ± 0.20	13.5 MAX.
	(inch)	0.069 ± 0.004	0.138 ± 0.002	0.157 ± 0.004	0.157 ± 0.004	0.079 ± 0.004	0.009 ± 0.002	0.315 ± 0.008	0.531 MAX.

Marking Code

Part Number	Marking Code
CPDQR5V0-HF	E5



xx = Product type marking code

Suggested PAD Layout

SIZE	0402/SOD-923F	
	(mm)	(inch)
A	0.750	0.030
B	0.500	0.020
C	0.700	0.028
D	1.250	0.049
E	0.250	0.010

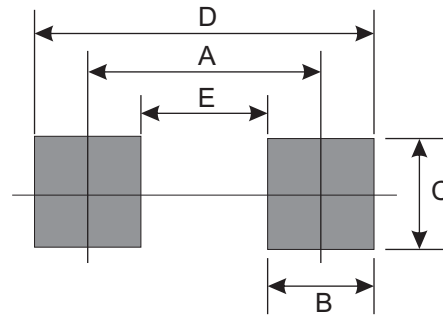

Standard Packaging

Case Type	Qty Per Reel	Reel Size
	(Pcs)	(inch)
0402/SOD-923F	5,000	7

Mouser Electronics

Authorized Distributor

Click to View Pricing, Inventory, Delivery & Lifecycle Information:

[Comchip Technology:](#)

[CPDQR5V0-HF](#) [CPDQR5V0](#)