

CODING A (GROOVES B-C) AS SHOWN  
 Kodierung A (Nuten B-C) wie gezeichnet

1

	10.7g	6	30	42.8	42.5	21	36	0.7g
	9.4g	5	25	37.8	37.5	18	31	0.65g
	8.3g	4	20	32.8	32.5	15	26	0.55g
	6.9g	3	15	27.8	27.5	12	21	0.5g
	5.8g	2	10	22.8	22.5	9	16	0.4g
	4.5g	1	5	17.8	17.5	6	11	0.35g

CODING A: CAVITY NUMBER. (CAVITIES ONLY SYMBOL.)  
 Kodierung A: Kammerbezeichnung. (Kammern nur symbol. dargestellt.)

WEIGHT n b<sub>±0.2</sub> c<sup>±0.4</sup> d<sub>±0.3</sub> POSITIONS Polzahl a<sub>±0.5</sub> WEIGHT Gewicht

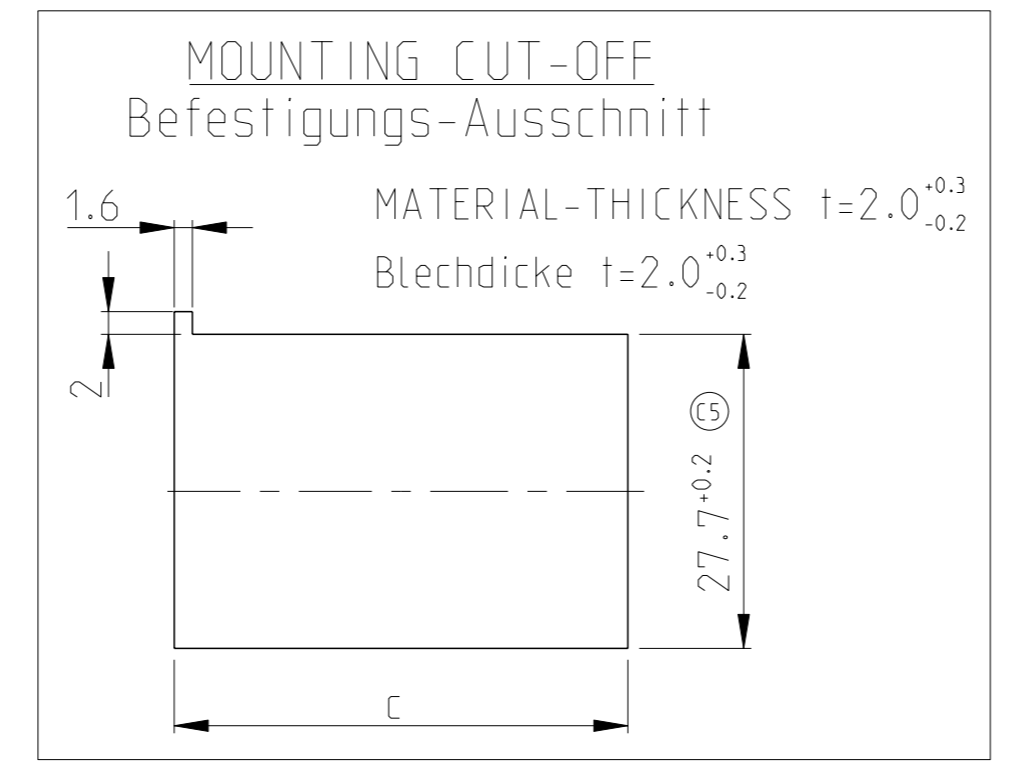

REV.	CL.	DESCRIPTION	DATE	OWN	APVD
C4		PNs added in table	06JUL2011	MM	SKR
C5		Tolerances to dimension 27.5 and 27.7 added.	30MAR2012	Kirs.	Krauss
C6		View updated: New variant 1-967629-0 added	18JUN2012	Mahnke	Krauss
C7		Location code changed	30JUL2013	Ho.	Krauss

2

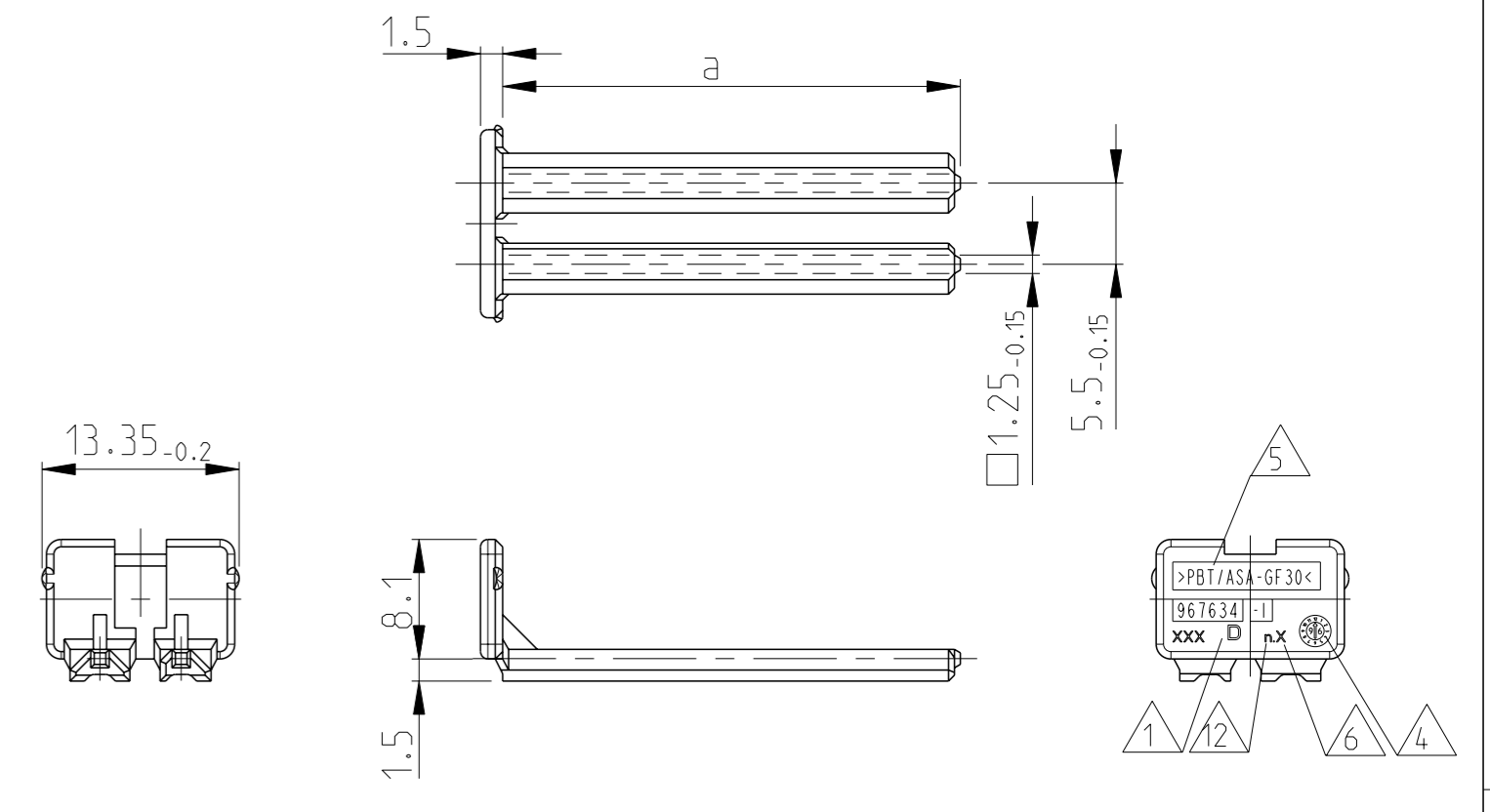

967634-1 AS SHOWN  
 wie gezeichnet

NOTES:  
 Bemerkungen:

- 1 ACTIVE COMPANY LOGO AND SINGLE PART NUMBER  
 Aktuelles Firmen-Logo und Bestell-Nr. Einzelteil
- 2 PRODUCTION-DATE  
 Produktionsdatum
- 3 CAVITY-MARKING  
 Kammerbezeichnung
- 4 THE REVISION STATUS OF THE MOULD  
 Aenderungsstand des Werkzeuges
- 5 MATERIAL-MARKING ACC. TO VDA 260  
 Werkstoffkennzeichnung nach VDA 260
- 6 MOLD CAVITY-MARKING  
 Nestmarkierung
- 7 WARPAGE TO ... PERMITTED  
 Verzug bis ... zulaessig
- 8 a: DIMENSION RESP. WEIGHT SECONDARY LOCKING DEVICE  
 a: Mass bzw. Gewicht der zweiten Kontaktsicherung
- 9 PACKAGING: LOOSE PIECE IN CORRUGATED BOX FOR BOTH PARTS (CONDITIONED HOUSING IN PLASTIC BAG)  
 Verpackung: Beide Teile werden lose im Karton geliefert (konditionierte Gehaeuse in Kunststoff-Beutel)
- 10 CAVITIES MATING WITH TAB.2.8mm (WITHOUT SINGLE WIRE SEAL)  
 MAX. WIRE SIZE 2.5mm<sup>2</sup> FLR - SEE DRAWING: Kontaktkammern passend fuer Flachstecker.2.8mm (ohne Einzel-Dichtungs-System)  
 max. Drahtgrosessenbereich 2.5mm<sup>2</sup> FLR - siehe Zeichnung: TE-No.: 1355052
- 11 MALFUNCTION CAUSED BY LACQUER IS NOT COVERED BY TE WARRANTY  
 Funktionsbeeintraechtigung durch Lackieren liegt nicht im Einfluss und Gewährleistungsumfang von TE
- 12 TOOL-NUMBERING  
 Werkzeugnummerierung

CODING / Kodierung D		CODING / Kodierung C		CODING / Kodierung B		CODING / Kodierung A												MECHANICAL CODING: mechanische Kodierung:																		
RIBS / Nuten: C-E		RIBS / Nuten: B-D		RIBS / Nuten: A-C		RIBS / Nuten: B-C																														
967635-1	D 2	21 POS. pol.	CLAY BROWN Lehm-braun	4-967630-1	E	3-967630-1	E	2-967630-1	E	-	-	-	-	1-967630-6	E	GENTIAN BLUE enzian-blau	1-967630-5	E	RAPE YELLOW raps-gelb	1-967630-4	E	YELLOW GREEN gelb-gruen	1-967630-3	E	TRAFFIC PURPLE verkehrs-purpur	1-967630-2	E	SLATE GREY schiefer-grau	1-967630-1	E	CLAY BROWN Lehm-braun	-	-	-	1	21 POS. polig
967634-1	D 2	18 POS. pol.	SLATE GREY schiefer-grau	4-967629-1	E	3-967629-1	E	2-967629-1	E	-	-	-	-	1-967629-6	E	CLAY BROWN Lehm-braun	1-967629-5	E	GENTIAN BLUE enzian-blau	1-967629-4	E	RAPE YELLOW raps-gelb	1-967629-3	E	YELLOW GREEN gelb-gruen	1-967629-2	E	TRAFFIC PURPLE verkehrs-purpur	1-967629-1	E	SLATE GREY schiefer-grau	1-967629-0	E	GRAPHITE BLACK graphit-schwarz	1	18 POS. polig
967633-1	D 2	15 POS. pol.	TRAFFIC PURPLE verkehrs-purpur	4-967628-1	E	3-967628-1	E	2-967628-1	E	-	-	-	-	1-967628-6	E	SLATE GREY schiefer-grau	1-967628-5	E	CLAY BROWN Lehm-braun	1-967628-4	E	GENTIAN BLUE enzian-blau	1-967628-3	E	RAPE YELLOW raps-gelb	1-967628-2	E	YELLOW GREEN gelb-gruen	1-967628-1	E	TRAFFIC PURPLE verkehrs-purpur	-	-	-	1	15 POS. polig
967632-1	D 2	12 POS. pol.	YELLOW GREEN gelb-gruen	4-967627-1	D	3-967627-1	D	2-967627-1	D	-	-	-	-	1-967627-6	D	TRAFFIC PURPLE verkehrs-purpur	1-967627-5	D	SLATE GREY schiefer-grau	1-967627-4	D	CLAY BROWN Lehm-braun	1-967627-3	D	GENTIAN BLUE enzian-blau	1-967627-2	D	RAPE YELLOW raps-gelb	1-967627-1	D	YELLOW GREEN gelb-gruen	-	-	-	1	12 POS. polig
967631-1	D 2	9 POS. pol.	RAPE YELLOW raps-gelb	4-967626-1	D	3-967626-1	D	2-967626-1	D	-	-	-	-	1-967626-6	D	YELLOW GREEN gelb-gruen	1-967626-5	D	TRAFFIC PURPLE verkehrs-purpur	1-967626-4	D	SLATE GREY schiefer-grau	1-967626-3	D	CLAY BROWN Lehm-braun	1-967626-2	D	GENTIAN BLUE enzian-blau	1-967626-1	D	RAPE YELLOW raps-gelb	-	-	-	1	9 POS. polig
968271-1	D 2	6 POS. pol.	GENTIAN BLUE enzian-blau	4-965641-1	D	3-965641-1	D	2-965641-1	D	1-965641-7	D	FLAME RED feuerrot	1-965641-6	D	RAPE YELLOW raps-gelb	1-965641-5	D	YELLOW GREEN gelb-gruen	1-965641-4	D	TRAFFIC PURPLE verkehrs-purpur	1-965641-3	D	SLATE GREY schiefer-grau	1-965641-2	D	CLAY BROWN Lehm-braun	1-965641-1	D	GENTIAN BLUE enzian-blau	-	-	-	1	6 POS. polig	

SECONDARY LOCKING DEVICE  
 zweite Kontaktsicherung

TAB HOUSING / Flachstecker-Gehaeuse

FURTHER MECHANICAL CODINGS:  
 weitere mechanische Kodierungen:

SCALE 1:1  
 M

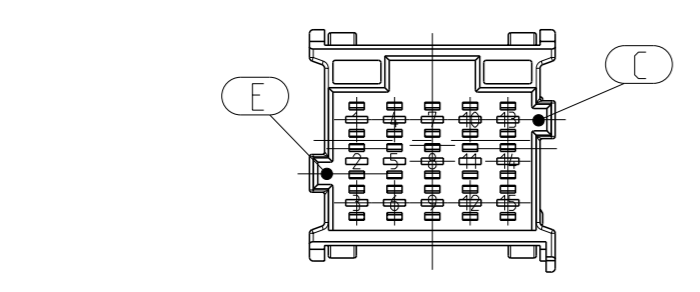

4-967628-1 SHOWN AS EXAMPLE  
 als Beispiel gezeigt

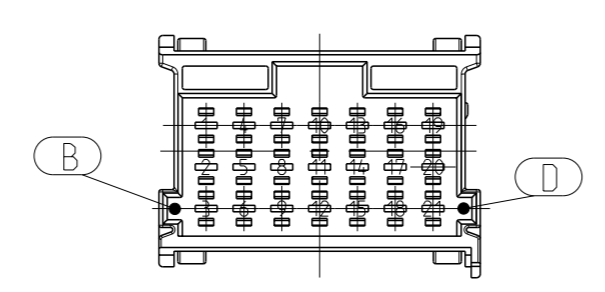

3-967630-1 SHOWN AS EXAMPLE  
 als Beispiel gezeigt

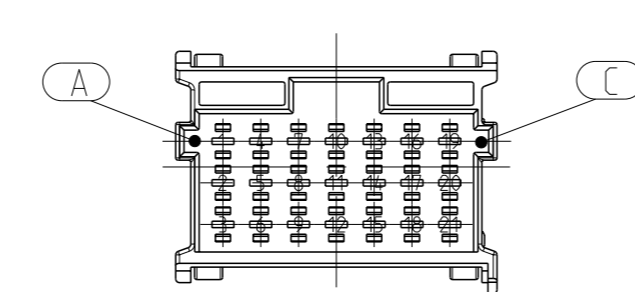

2-967630-1 SHOWN AS EXAMPLE  
 als Beispiel gezeigt

THIS DRAWING IS A CONTROLLED DOCUMENT.		OWN R. Gerlach 15APR98	TE Connectivity
DIMENSIONS: mm		CHK R. Huebner 15APR98	APVD J. Hase 15APR98
TOLERANCES UNLESS OTHERWISE SPECIFIED: # 100 BOS # 1000-10		NAME PRODUCT GROUP DRAWING: TAB HOUSING (2.8mm). 6-21POS. AND SECONDARY LOCKING DEVICE. Produkt-Gruppen-Zeichnung fuer: Flachstecker Gehaeuse (2.8mm), 6-21pol. und zweite Kontaktsicherung	
MATERIAL SEE TABLE		WEIGHT SEE TABLE	SIZE CAGE CODE DRAWING NO RESTRICTED TO A1 00779 ©=1355072
Customer Drawing		SCALE 2:1	SHEET 1 of 2 REV 7

MATED WITH / ERSETZT ZU: SEE 1355071 and 1355073	PROJEKT NR. A92-52228	LOC A1	DIST -	REVISIONS			
				REV.	DATE	OWN	APVD
				rev_sym_5	rev_desc_5	rev_date_5	rev_dwn_5

# ADDITIONAL CODINGS / Zusätzliche Kodierungen

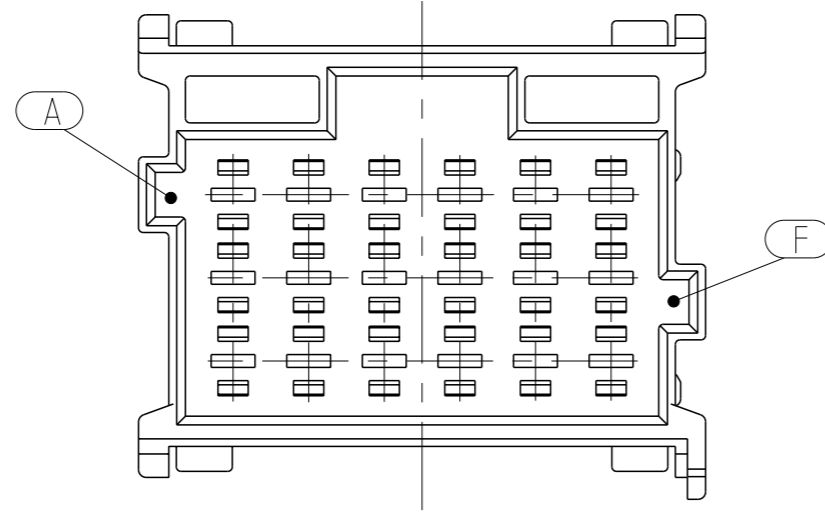

CODING / Kodierung F			MECHANICAL CODING: mechanische Kodierung:	
RIBS / Nuten: A-F				
	6-967630-1	E	21	POS. pol.
	6-967629-1	E	18	POS. pol.
			15	POS. pol.
	6-967627-1	D	12	POS. pol.
			9	POS. pol.
	6-965641-1	D	6	POS. pol.
CUSTOMER PART NUMBER Kunden-Einzelteil-Nummer	TE ORDER-NO. TE Bestell-Nr.	REV.	DESCRIPTION Benennung Einzelteil	
			MATERIAL SPEC.	

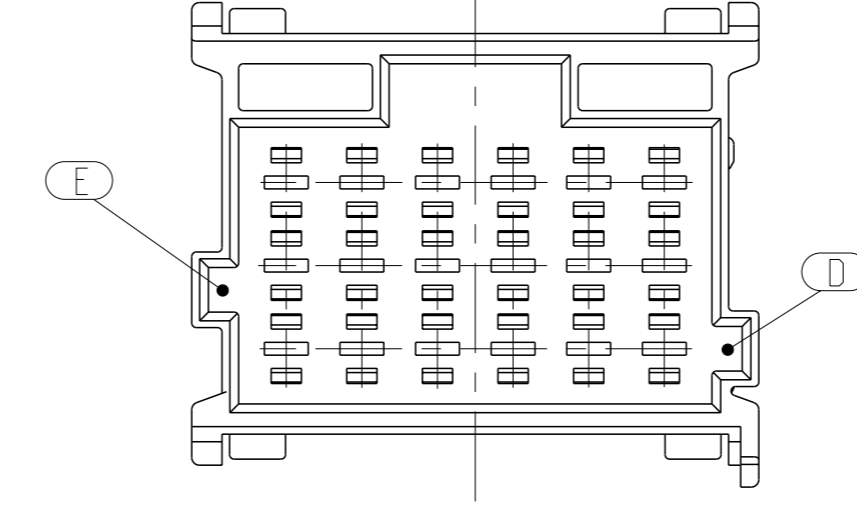

CODING / Kodierung E			MECHANICAL CODING: mechanische Kodierung:	
RIBS / Nuten: E-D				
	5-967630-1	E	21	POS. pol.
	5-967629-1	E	18	POS. pol.
			15	POS. pol.
	5-967627-1	D	12	POS. pol.
			9	POS. pol.
	5-965641-1	D	6	POS. pol.
CUSTOMER PART NUMBER Kunden-Einzelteil-Nummer	TE ORDER-NO. TE Bestell-Nr.	REV.	DESCRIPTION Benennung Einzelteil	
			MATERIAL SPEC.	

THIS DRAWING IS A CONTROLLED DOCUMENT.

DIMENSIONS: mm	TOLERANCES UNLESS OTHERWISE SPECIFIED: n. ISO 2768-MS	OWN: K. Gerlach 15APR98	CHK: R. Huebner 15APR98	APVD: 15APR98	NAME: PRODUCT GROUP DRAWING: TAB HOUSING (2.8mm), 6-21POS. AND SECONDARY LOCKING DEVICE
	0 PLC ± 1 PLC ± 2 PLC ± 3 PLC ± 4 PLC ±	SIZE: 00779	CAGE CODE: 1355072	DRAWING NO: 00779	RESTRICTED TO: -
MATERIAL: SEE TABLE	FINISH: SEE TABLE	WEIGHT: SEE TABLE	Customer Drawing	SCALE: 2:1	SHEET 2 OF 2

4805 (3/11)

# Mouser Electronics

Authorized Distributor

Click to View Pricing, Inventory, Delivery & Lifecycle Information:

[TE Connectivity:](#)

[3-967628-1](#)