

CRYSTAL CLOCK OSCILLATORS (SMD · Ceramic Package)

RoHS compliant

CSX-750F

1,000pcs/reel

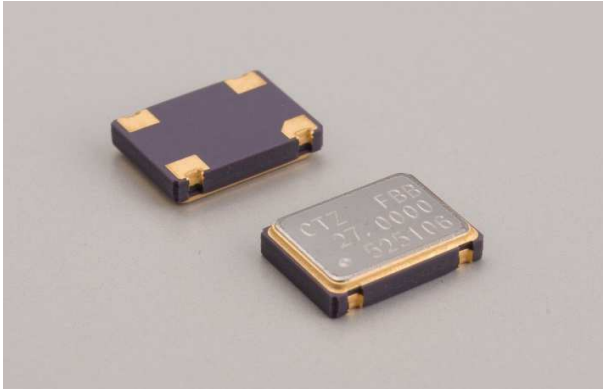

FEATURES

- Frequency range : 1.0 ~ 80.0MHz
- External dimensions (mm)
L : 7.0 x W : 5.0 x H : 1.6
- Applications
Consumer products

DIMENSION [mm]

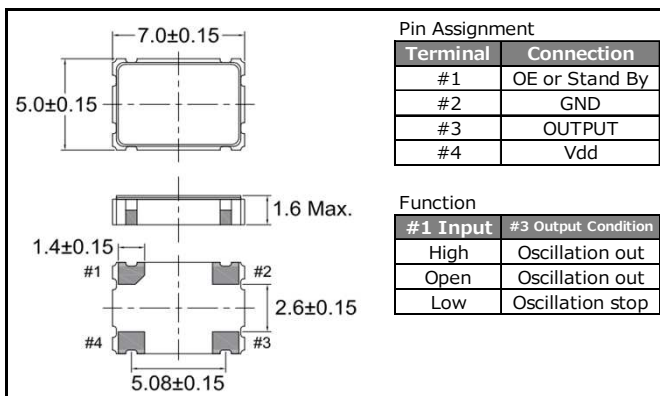

SOLDER PAD LAYOUT [mm]

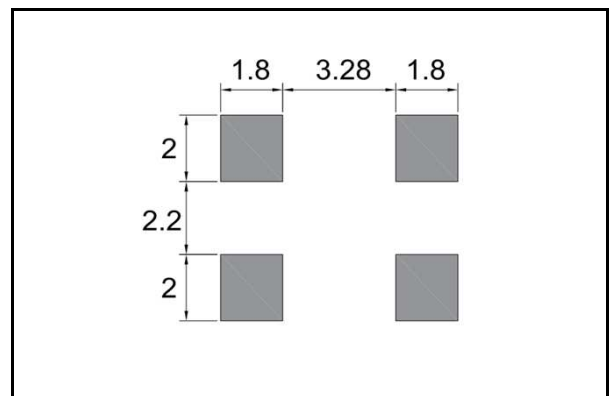

STANDARD SPECIFICATIONS

*Model is determined by selection of OE/ST functions, frequency stability, and supply voltage.

Item	Model	OE	CSX-750FC (*)		CSX-750FB (*)	CSX-750FJ (*)
		STAND-BY				
Frequency Range			1.8432~39.999MHz	40.000~75.000MHz	1.8432~39.999MHz	40.000~80.000MHz
Supply Voltage			Vdd: 5.0V±0.5V		Vdd: 3.3V±0.3V	
Frequency Stability	(*)		B: ±50ppm(-20°C ~ +70°C), C: ±100ppm(-20°C ~ +70°C) E: ±50ppm(-40°C ~ +85°C), F: ±100ppm(-40°C ~ +85°C)			
Operating Temperature Range			-20°C ~ +70°C / (-40°C ~ +85°C)			
Storage Temperature Range			-55°C ~ +125°C			
Current consumption			25mA Max.	45mA Max.	15mA Max.	25mA Max.
Duty	TTL level (1.4V)		40~60%		—	
	CMOS level (1/2 Vdd)				45~55%	
Output Voltage	V _{OH}				0.9Vdd Min.	
	V _{OL}		0.4V Max.		0.1Vdd Max.	
Output Load	TTL		10TTL Max.		—	
	CMOS		50pF Max.		30pF Max.	
Rise and Fall Time			8 nsec Max.	6 nsec Max.	8 nsec Max.	6 nsec Max.
Start-up time			4 msec Max.	10 msec Max.	4 msec Max.	10 msec Max.
Input Voltage	V _{IH}		2.0V Min.			0.7Vdd Min.
	V _{IL}		0.8V Max.		0.4V Max.	0.3Vdd Max.
Disable current			10mA Max.	20mA Max.	5mA Max.	—
Stand-by current			—		10 μA Max.	

■ PART NUMBERING SYSTEM

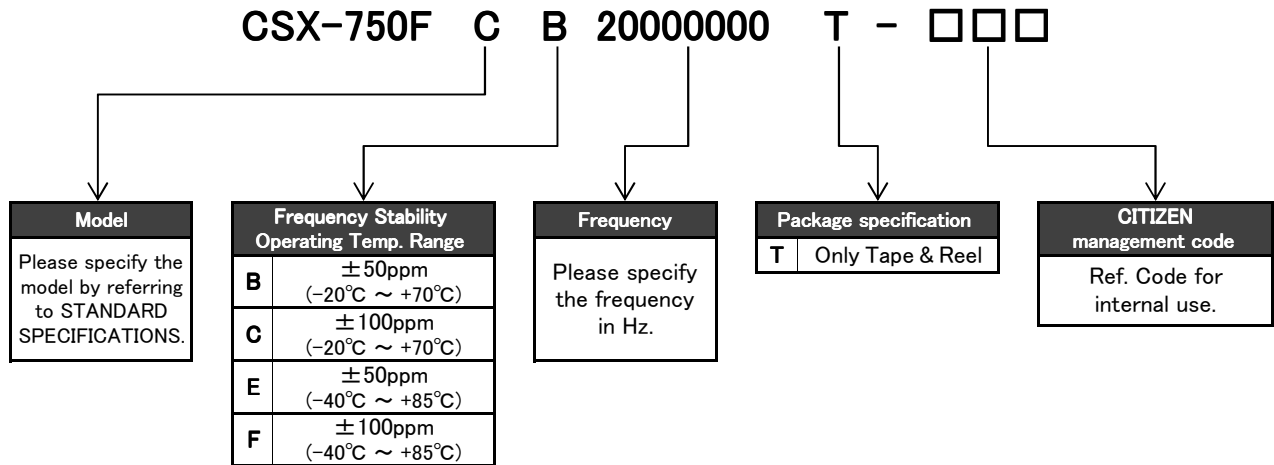

*Please contact us for specifications available.

■ Part Marking [standard]

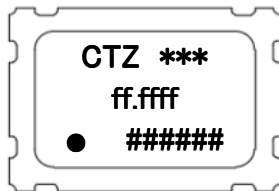

CTZ : Manufacture's ID Code

* : Model

f : Frequency

: Production Lot No.

■ Reflow profile

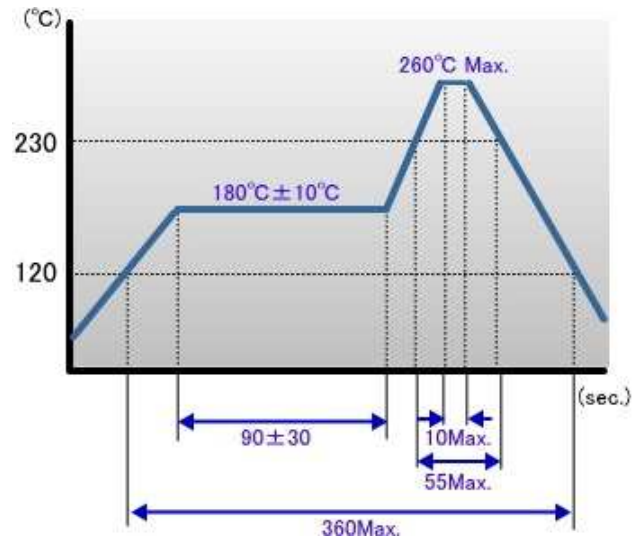

■ Packing

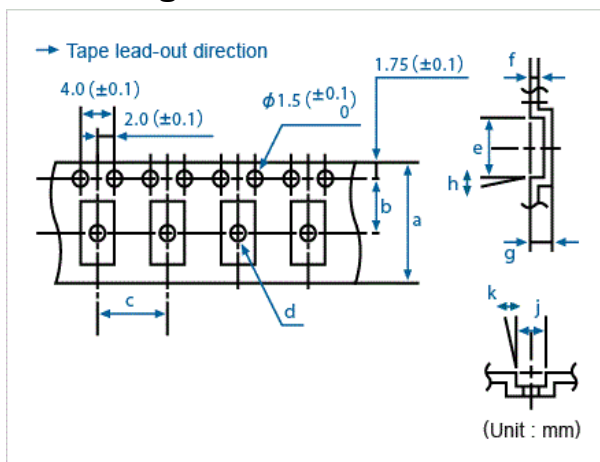

Conforming to JIS C 0806 TB1208NEIAJ and RC-1009B TE1208N

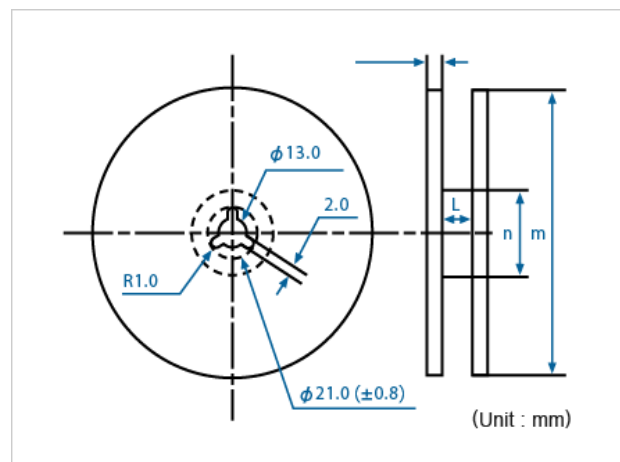

Conforming to JIS C 0806 R12R and EIAJ RC-1009B R15

Q'ty/reel	a	b	c	d (φ)	e	f	g	h	j	k	l	m (φ)	n (φ)
1,000	16.0	7.5	8.0	1.5	7.4	0.3	1.9	5°	5.4	5°	16.0	180	62

Product specifications are subject to change without notice.

Rev.2

Mouser Electronics

Authorized Distributor

Click to View Pricing, Inventory, Delivery & Lifecycle Information:

Citizen:

[CSX750FCC-11.0592M-UT](#) [CSX750FCC-22.1184M-UT](#) [CSX750FJC-66.666M-UT](#) [CSX750FJC-64.000M-UT](#)
[CSX750FCC-14.31818M-UT](#) [CSX750FBC-10.000M-UT](#) [CSX750FBC-12.000M-UT](#) [CSX750FBC-16.000M-UT](#)
[CSX750FBC-9.8304M-UT](#) [CSX750FBC-32.000M-UT](#) [CSX750FCC-14.7456M-UT](#) [CM206T-32.768KDZB-UT](#)
[CSX750FBC-14.31818M-UT](#) [CSX750FBC-14.7456M-UT](#) [CSX750FJC-106.250M-UT](#) [CSX750FCC-32.000M-UT](#)
[CSX750FCC-30.000M-UT](#) [CSX750FJC-60.000M-UT](#) [CSX750FBC-4.096M-UT](#) [CSX750FBC-11.0592M-UT](#)
[CSX750FBC-24.576M-UT](#) [CSX750FJC-80.000M-UT](#) [CSX750FCC-32.768M-UT](#) [CSX750FCC-33.333M-UT](#)
[CSX750FBC-3.6864M-UT](#) [CSX750FCC-29.4912M-UT](#) [CSX750FBC-18.432M-UT](#) [CSX750VJB-20.000-MUT](#)
[CSX750VCB-27.000M-UT](#) [CSX750FCC-10.000M-UT](#) [CSX750FCC-1.8432M-UT](#) [CSX750FCC-35.328M-UT](#)
[CSX750FJC-40.000M-UT](#) [CSX750FJC-125.000M-UT](#) [CSX750FJC-48.000M-UT](#) [CSX750FCC-16.000M-UT](#)
[CSX750VKB-32.768M-UT](#) [CSX750FCC-12.000M-UT](#) [CSX750FJC-49.152000M-UT](#) [CSX750FCC-50.000M-UT](#)
[CSX750FCC-3.6864M-UT](#) [CSX750VKB-12.288M-UT](#) [CSX750FBC-4.000M-UT](#) [CSX750FBC-8.000M-UT](#)
[CSX750FBC-32.768M-UT](#) [CSX750FBC-16.384M-UT](#) [CSX750FCC-12.288M-UT](#) [CSX750VKE-35.328M-UT](#)
[CSX750FBC-35.328M-UT](#) [CSX750FCC-20.000M-UT](#) [CSX750FCC-27.000M-UT](#) [CSX750VBEL-20.000M-UT](#)
[CSX750FBC-1.8432M-UT](#) [CSX750FCC-24.000M-UT](#) [CSX750FJB-80.000M-UB](#) [CSX750FCC-66.666M-UT](#)
[CSX750FBC-7.3728M-UT](#) [CSX750FCC-16.384M-UT](#) [CSX750FBC-29.4912M-UT](#) [CSX750FCC-25.000M-UT](#)
[CSX750VKB-25.00M-UT](#) [CSX750FBC-30.000M-UT](#) [CSX750FBC-33.333M-UT](#) [CSX750FCC-18.432000M-UT](#)
[CSX750FBC-12.288M-UT](#) [CSX750FCC-24.576M-UT](#) [CSX750FCC-64.000M-UT](#) [CSX750FBC-20.000M-UT](#)
[CSX750FBC-27.000M-UT](#) [CSX750VKB-35.328M-UT](#) [CSX750FJC-66.000M-UT](#) [CSX750FBC-24.000M-UT](#)
[CSX750FJC-50.000M-UT](#) [CSX750FBC-36.000M-UT](#) [CSX750FCC-7.3728M-UT](#) [CSX750FCC-60.000M-UT](#)
[CSX750FJC-100.000M-UT](#) [CSX750FBC-25.000M-UT](#) [CSX750FJC-66.667M-UT](#) [CSX750FCC-8.000M-UT](#)
[CSX750FCC-40.000M-UT](#) [CSX750FCC-48.000M-UT](#) [CSX750FBC-8.192M-UT](#) [CSX750FCC-4.000M-UT](#)
[CSX750FCC-66.667M-UT](#) [CSX750FJB-106.25M-UB](#) [CSX750FJC133.33M-UT](#) [CSX750VJB-27.000M-UT](#)
[CSX750VBBL-16.384M-UT](#) [CSX750VCBM-25.000M-UT](#) [CSX750FCC-18.432M-UT](#) [CSX750FJF-60.000M-UT](#)
[CSX750FJC-66.666M-U](#) [CSX750FBC-4.096MTR](#) [CSX750FCC-66.667MTR](#) [CSX750FBC-9.8304MTR](#) [CSX750FJB-](#)
[125.000MB](#) [CSX750FCC-22.1184MTR](#) [CSX750FJC-133.330M-UT](#) [CSX750FJC-66.667MTR](#)