

EVA-W

~40° wide beam

TECHNICAL SPECIFICATIONS:

Dimensions	Ø 35.0 mm
Height	16.4 mm
Fastening	glue
Colour	clear
Box size	480 x 280 x 300 mm
Box weight	5.5 kg
Quantity in Box	540 pcs
ROHS compliant	yes ⓘ



MATERIAL SPECIFICATIONS:

Component	Type	Material	Colour
EVA-W	Lens	PMMA	clear

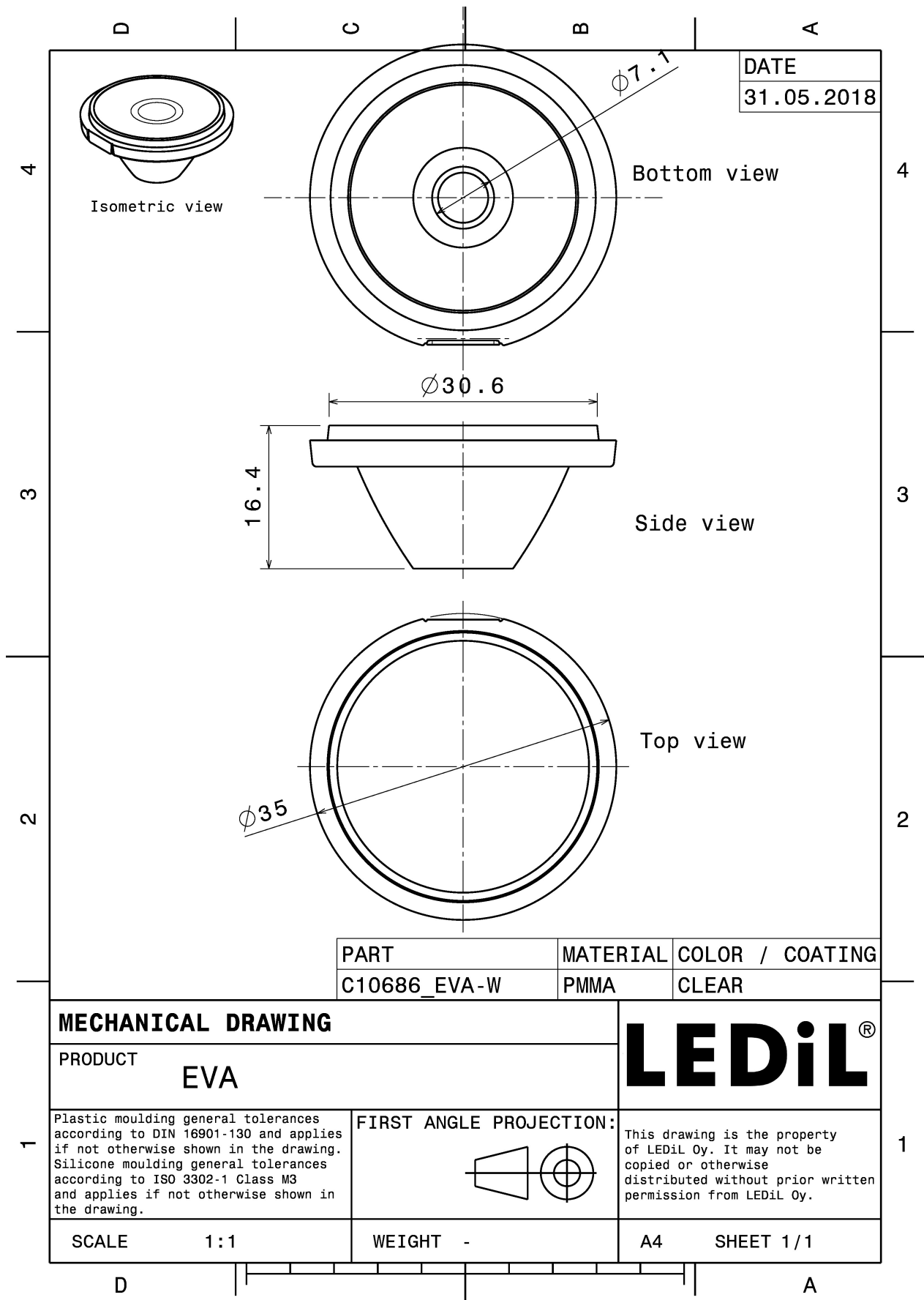

PHOTOMETRIC DATA (MEASURED):

CITIZEN

LED CLU LES 4.2mm (HI-Ver.3)
 FWHM 35.0°
 Efficiency 86 %
 Peak intensity 1.900 cd/lm
 Required components:

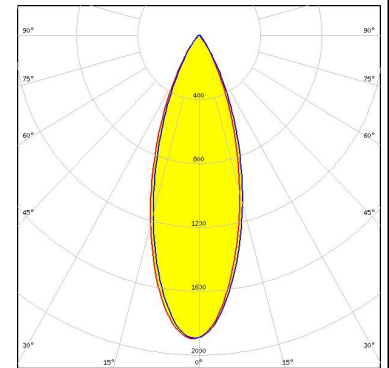

CREE

LED MC-E
 FWHM 36.0°
 Efficiency 91 %
 Peak intensity 1.000 cd/lm
 Required components:

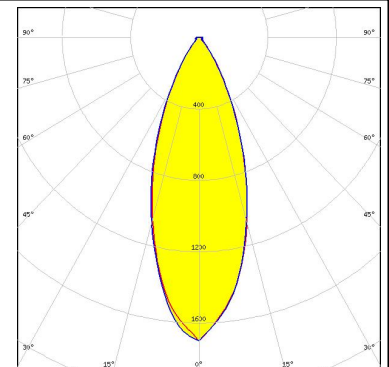
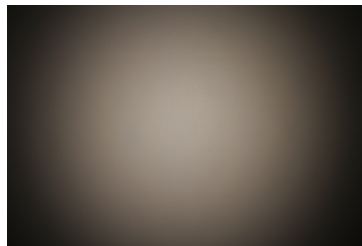

CREE

LED MHB-A/B
 FWHM 39.0°
 Efficiency 78 %
 Peak intensity 1.670 cd/lm
 Required components:

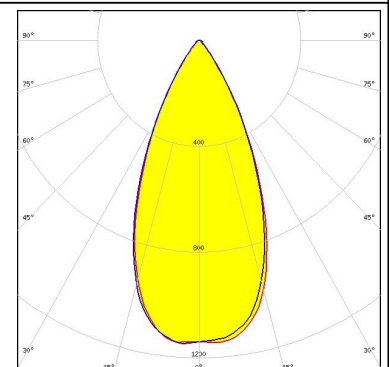

CREE

LED MK-R
 FWHM 48.0°
 Efficiency %
 Peak intensity 1.150 cd/lm
 Required components:



PHOTOMETRIC DATA (MEASURED):

CREE

LED XHP35 HI
FWHM 57.0°
Efficiency 75 %
Peak intensity 0.810 cd/lm
Required components:



CREE

LED XM-L
FWHM 40.0°
Efficiency 79 %
Peak intensity cd/lm
Required components:

CREE

LED XP-G2
FWHM 32.0°
Efficiency 81 %
Peak intensity 2.200 cd/lm
Required components:

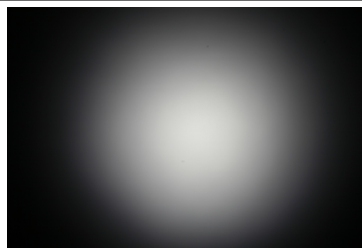

CREE

LED XT-E
FWHM 32.0°
Efficiency %
Peak intensity 1.800 cd/lm
Required components:

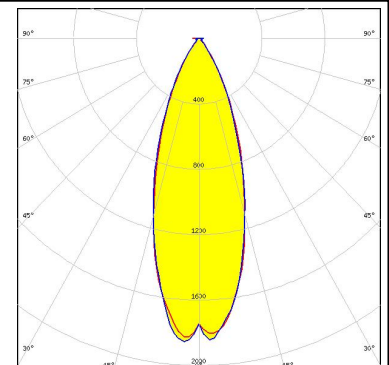

PHOTOMETRIC DATA (MEASURED):



LED LUXEON 5050
FWHM 37.0°
Efficiency 83 %
Peak intensity 1.700 cd/lm
Required components:

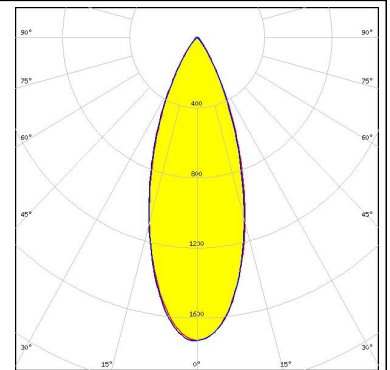

LED LUXEON M/MX
FWHM 45.0°
Efficiency 80 %
Peak intensity 1.300 cd/lm
Required components:

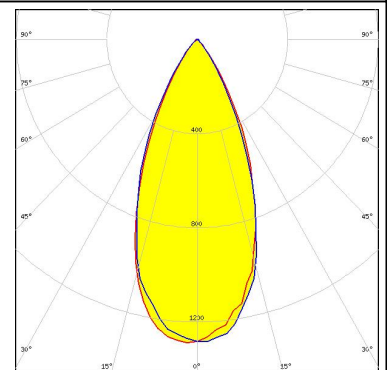

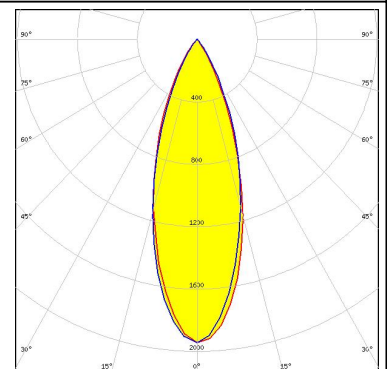
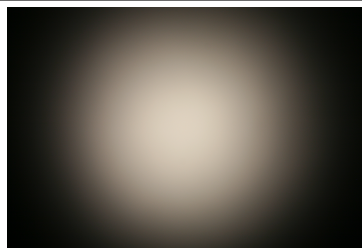

LED LUXEON MZ
FWHM 36.0°
Efficiency 81 %
Peak intensity 1.900 cd/lm
Required components:

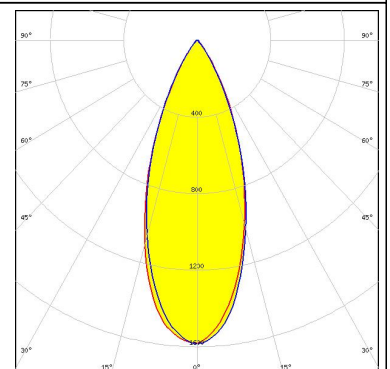
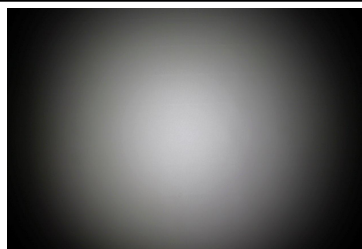

LED NS9x383
FWHM 39.0°
Efficiency 81 %
Peak intensity 1.600 cd/lm
Required components:

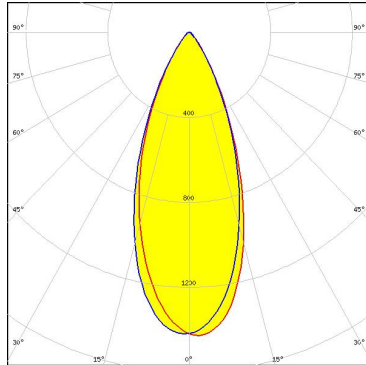
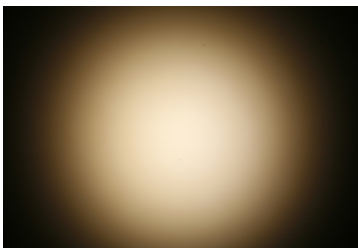
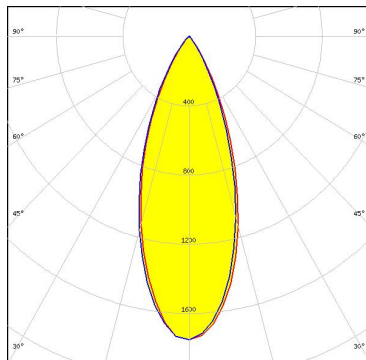

PHOTOMETRIC DATA (MEASURED):

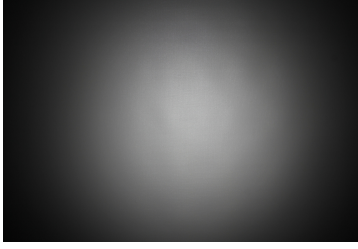
<p>NICHIA</p> <p>LED NSMx286M FWHM 41.0° Efficiency 80 % Peak intensity 1.430 cd/lm Required components:</p>		
<p>OSRAM Opto Semiconductors</p> <p>LED Duris S8 FWHM 39.0° Efficiency 81 % Peak intensity 1.800 cd/lm Required components:</p>		
<p>SEOUL SEMICONDUCTOR</p> <p>LED Z8Y15 FWHM 29.0° Efficiency 80 % Peak intensity 2.310 cd/lm Required components:</p>		
<p>SEOUL SEMICONDUCTOR</p> <p>LED Z8Y19 FWHM 30.0° Efficiency 81 % Peak intensity 2.340 cd/lm Required components:</p>		

PHOTOMETRIC DATA (SIMULATED):



LED XM-L HVW
FWHM 38.0°
Efficiency %
Peak intensity cd/lm
Required components:



LED LUXEON 5258
FWHM 34.0°
Efficiency 87 %
Peak intensity 1.900 cd/lm
Required components:

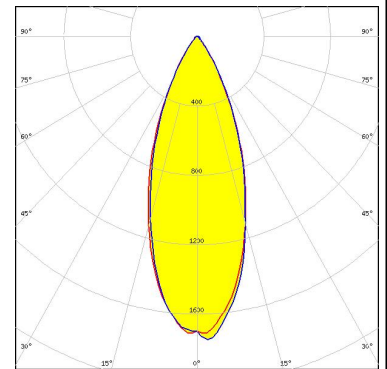

LED OSCONIQ P 7070
FWHM 41.0°
Efficiency 87 %
Peak intensity 1.600 cd/lm
Required components:

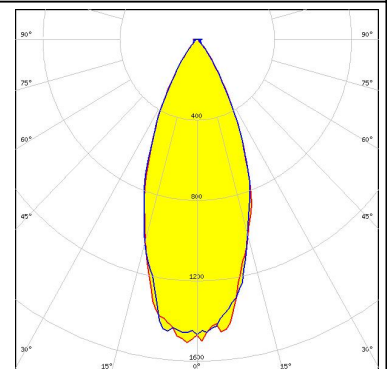

GENERAL INFORMATION:

NOTE: The typical beam angle will be changed by different color, chip size and chip position tolerance. The typical total beam angle is the full angle measured where the luminous intensity is half of the peak value.

Due to use of high power COB's with this product, special attention to proper thermal design is highly recommended. LEDiL has no liability for direct, indirect or consecutive damages arising from the LEDiL products being used outside of the recommended temperature range.

MATERIALS:

As part of our continuous research and improvement processes, and to ensure the best possible quality and availability of our products, LEDiL reserves the right to change material grades without notice.

PRODUCT DATA USER AGREEMENT AND DISCLAIMER:

The measured data in the provided downloadable LEDiL Product Datasheets and Mechanical 2D-Drawings is rounded and provided as reference for planning. LEDiL Oy's optical specifications have been verified by conducting performance testing of the products in accordance with the company's quality system. The reported data are averaged results of multiple measurements with typical variation. LEDiL Oy reserves the right to without prior notification make changes and improvements to its products.

LEDiL Oy assumes neither warranty, nor guarantee nor any other liability of any kind for the contents and correctness of the provided data. The provided data has been generated with highest diligence but the provided data may in reality not represent the complete possible variation range of all intrinsic parameters. Therefore, in certain cases a deviation from the provided data could occur.

LEDiL Oy reserves the right to undertake technical changes of its products without further notification which could lead to changes in the provided data. LEDiL Oy assumes no liability of any kind for the possible deviation from any provided data or any other damage resulting from the usage of the provided data.

The user agrees to this disclaimer and user agreement with the download or usage of the provided files.

LEDiL Oy

Joensuunkatu 13
FI-24240 SALO
Finland

LEDiL Inc.

228 West Page Street
Suite D
Sycamore IL 60178
USA

Local sales and technical support

[www.ledil.com/
where_to_buy](http://www.ledil.com/where_to_buy)

Shipping locations

Salo, Finland
Hong Kong, China

Distribution Partners

[www.ledil.com/
where_to_buy](http://www.ledil.com/where_to_buy)

Mouser Electronics

Authorized Distributor

Click to View Pricing, Inventory, Delivery & Lifecycle Information:

[Ledi:](#)

[C10686_EVA-W](#)