

IRF6201PbF

HEXFET® Power MOSFET

V_{DS}	20	V
R_{DS(on)} max (@V _{GS} = 4.5V)	2.45	mΩ
R_{DS(on)} max (@V _{GS} = 2.5V)	2.75	mΩ
Q_g (typical)	130	nC
I_D (@T _A = 25°C)	27	A

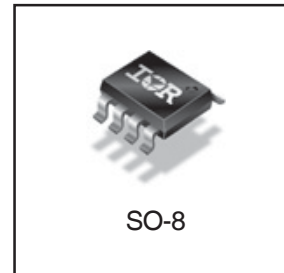
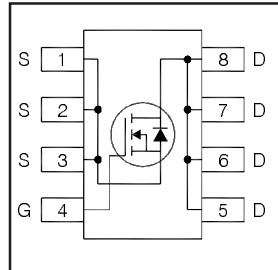

Applications

- OR-ing or hot-swap MOSFET
- Battery operated DC motor inverter MOSFET
- System/Load switch

Features and Benefits

Features

Low R _{DSon} (≤ 2.45mΩ @ V _{gs} = 4.5V)
Industry-standard SO-8 package
RoHS compliant containing no lead, no bromide and no halogen

results in
 ⇒

Benefits

Lower conduction losses
Multi-vendor compatibility
Environmentally Friendly

Orderable part number	Package Type	Standard Pack		Note
		Form	Quantity	
IRF6201PbF	SO8	Tube/Bulk	95	
IRF6201TRPbF	SO8	Tape and Reel	4000	

Absolute Maximum Ratings

	Parameter	Max.	Units
V _{DS}	Drain-to-Source Voltage	20	V
V _{GS}	Gate-to-Source Voltage	±12	
I _D @ T _A = 25°C	Continuous Drain Current, V _{GS} @ 4.5V	27	A
I _D @ T _A = 70°C	Continuous Drain Current, V _{GS} @ 4.5V	22	
I _{DM}	Pulsed Drain Current ①	110	
P _D @ T _A = 25°C	Power Dissipation ③	2.5	W
P _D @ T _A = 70°C	Power Dissipation ③	1.6	
	Linear Derating Factor	0.02	W/°C
T _J	Operating Junction and	-55 to + 150	°C
T _{STG}	Storage Temperature Range		

Static @ $T_J = 25^\circ\text{C}$ (unless otherwise specified)

	Parameter	Min.	Typ.	Max.	Units	Conditions
BV_{DSS}	Drain-to-Source Breakdown Voltage	20	—	—	V	$V_{GS} = 0V, I_D = 250\mu A$
$\Delta BV_{DSS}/\Delta T_J$	Breakdown Voltage Temp. Coefficient	—	4.6	—	mV/ $^\circ\text{C}$	Reference to $25^\circ\text{C}, I_D = 1\text{mA}$
$R_{DS(on)}$	Static Drain-to-Source On-Resistance	—	1.90	2.45	m Ω	$V_{GS} = 4.5V, I_D = 27A$ ②
		—	2.10	2.75		$V_{GS} = 2.5V, I_D = 22A$ ②
$V_{GS(th)}$	Gate Threshold Voltage	0.5	—	1.1	V	$V_{DS} = V_{GS}, I_D = 100\mu A$
I_{DSS}	Drain-to-Source Leakage Current	—	—	1.0	μA	$V_{DS} = 16V, V_{GS} = 0V$
		—	—	150		$V_{DS} = 16V, V_{GS} = 0V, T_J = 125^\circ\text{C}$
I_{GSS}	Gate-to-Source Forward Leakage	—	—	100	nA	$V_{GS} = 12V$
	Gate-to-Source Reverse Leakage	—	—	-100		$V_{GS} = -12V$
Q_g	Total Gate Charge	—	130	195	nC	$V_{GS} = 4.5V$
Q_{gs}	Gate-to-Source Charge	—	16	—		$V_{DS} = 10V$
Q_{gd}	Gate-to-Drain Charge	—	60	—		$I_D = 22A$
$t_{d(on)}$	Turn-On Delay Time	—	29	—	ns	$V_{DD} = 20V, V_{GS} = 4.5V$
t_r	Rise Time	—	100	—		$I_D = 1.0A$
$t_{d(off)}$	Turn-Off Delay Time	—	320	—		$R_G = 6.8\Omega$
t_f	Fall Time	—	265	—		See Figs. 10a & 10b
C_{iss}	Input Capacitance	—	8555	—	pF	$V_{GS} = 0V$
C_{oss}	Output Capacitance	—	1735	—		$V_{DS} = 16V$
C_{rss}	Reverse Transfer Capacitance	—	1290	—		$f = 1.0\text{MHz}$

Diode Characteristics

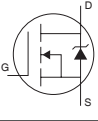
	Parameter	Min.	Typ.	Max.	Units	Conditions
I_S	Continuous Source Current (Body Diode)	—	—	2.5	A	MOSFET symbol showing the integral reverse p-n junction diode. 
I_{SM}	Pulsed Source Current (Body Diode) ①	—	—	110		
V_{SD}	Diode Forward Voltage	—	—	1.2	V	$T_J = 25^\circ\text{C}, I_S = 2.5A, V_{GS} = 0V$ ②
t_{rr}	Reverse Recovery Time	—	82	120	ns	$T_J = 25^\circ\text{C}, I_F = 2.5A, V_{DD} = 16V$
Q_{rr}	Reverse Recovery Charge	—	180	270	nC	$di/dt = 100/\mu s$ ②

Thermal Resistance

	Parameter	Typ.	Max.	Units
$R_{\theta JL}$	Junction-to-Drain Lead ④	—	20	$^\circ\text{C/W}$
$R_{\theta JA}$	Junction-to-Ambient ③	—	50	

Notes:

- ① Repetitive rating; pulse width limited by max. junction temperature.
- ② Pulse width $\leq 400\mu s$; duty cycle $\leq 2\%$.
- ③ When mounted on 1 inch square copper board.
- ④ R_{θ} is measured at T_J approximately 90°C .

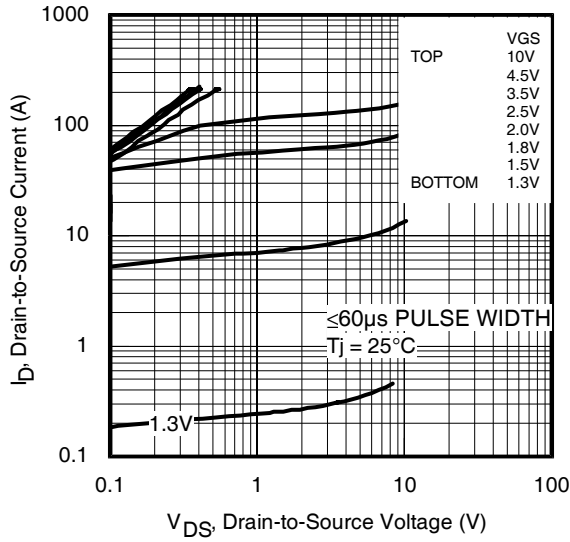

Fig 1. Typical Output Characteristics

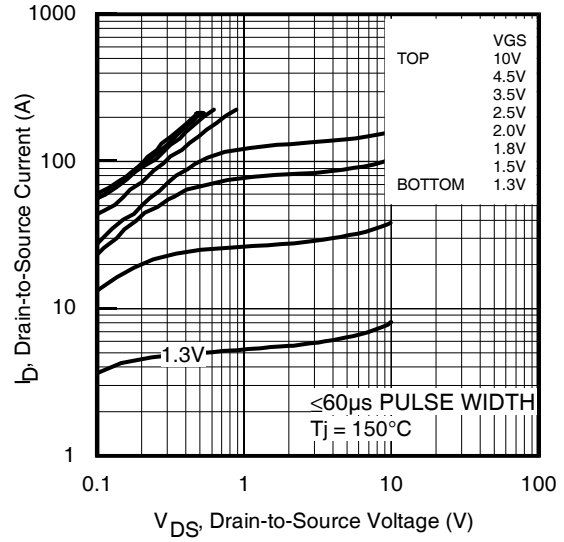

Fig 2. Typical Output Characteristics

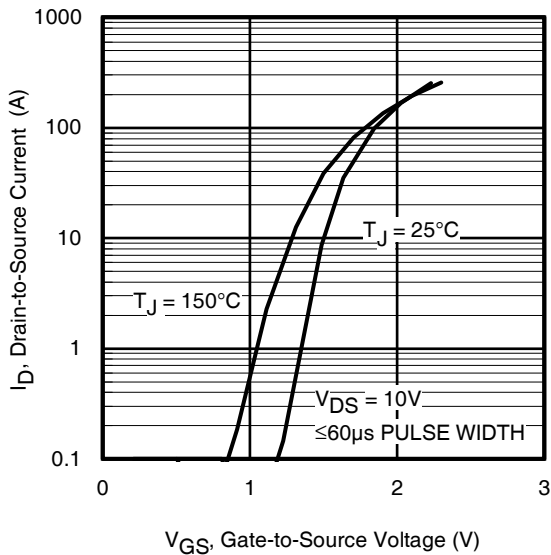

Fig 3. Typical Transfer Characteristics

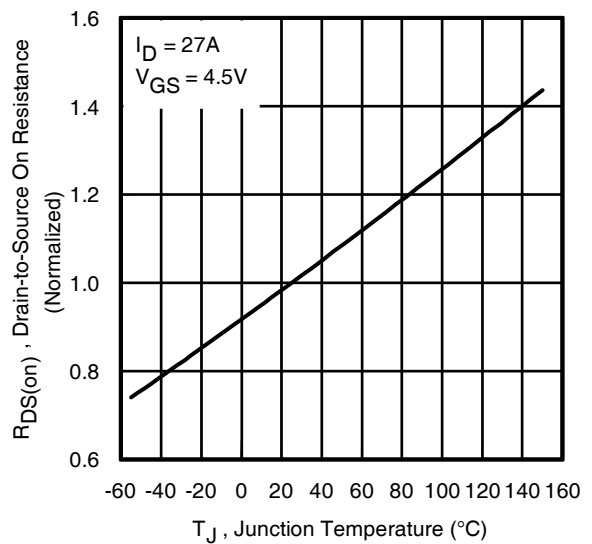

Fig 4. Normalized On-Resistance vs. Temperature

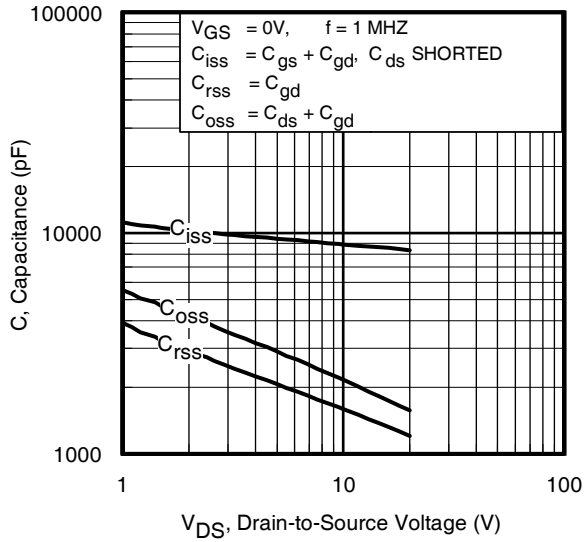

Fig 5. Typical Capacitance vs. Drain-to-Source Voltage

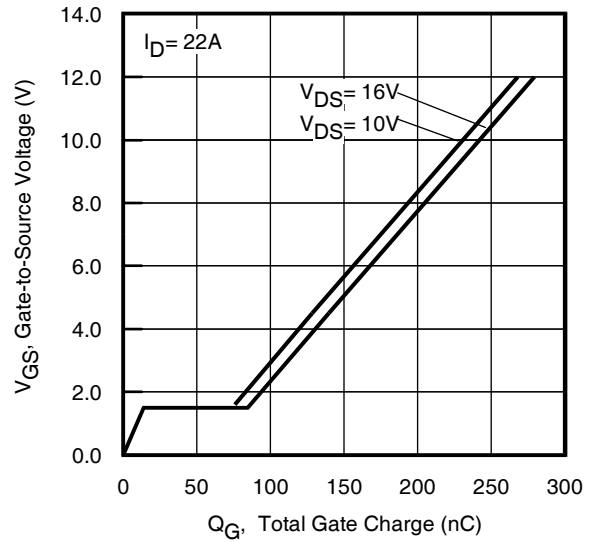

Fig 6. Typical Gate Charge vs. Gate-to-Source Voltage

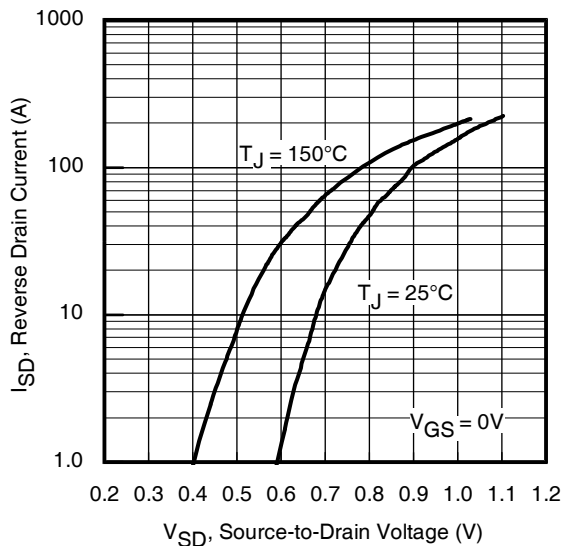

Fig 7. Typical Source-Drain Diode Forward Voltage

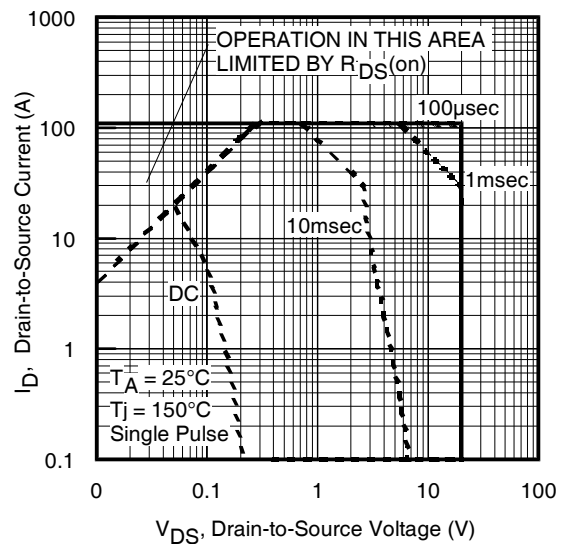

Fig 8. Maximum Safe Operating Area

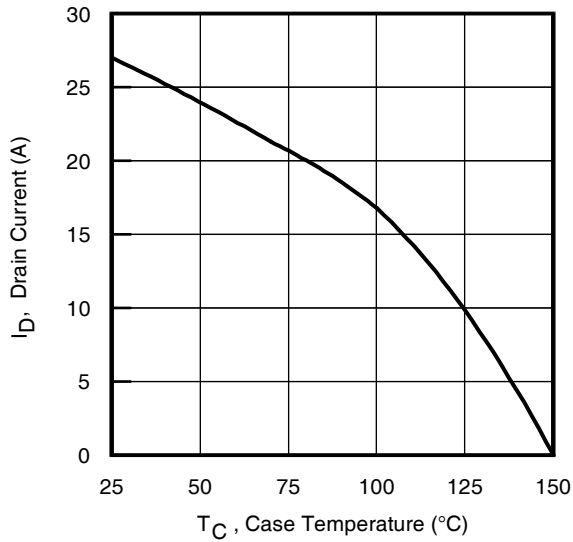

Fig 9. Maximum Drain Current vs. Case Temperature

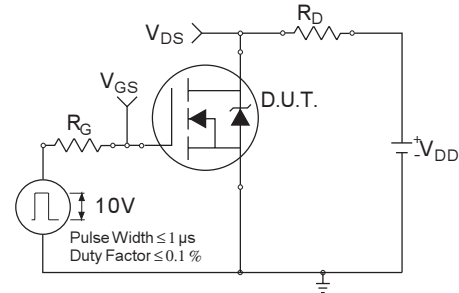

Fig 10a. Switching Time Test Circuit

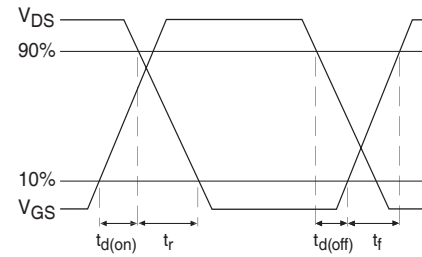

Fig 10b. Switching Time Waveforms

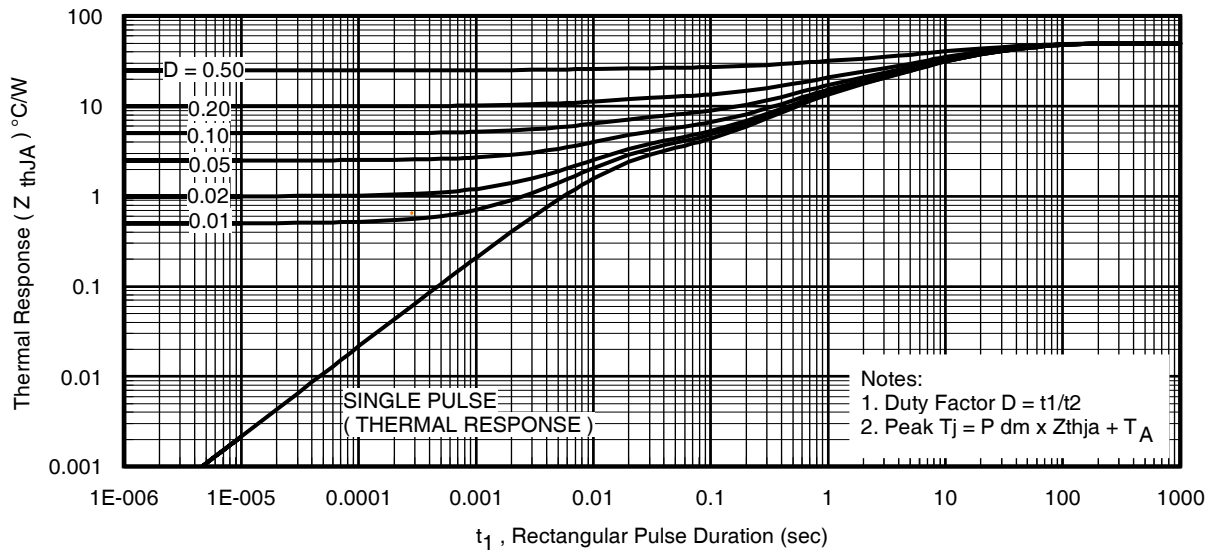

Fig 11. Typical Effective Transient Thermal Impedance, Junction-to-Ambient

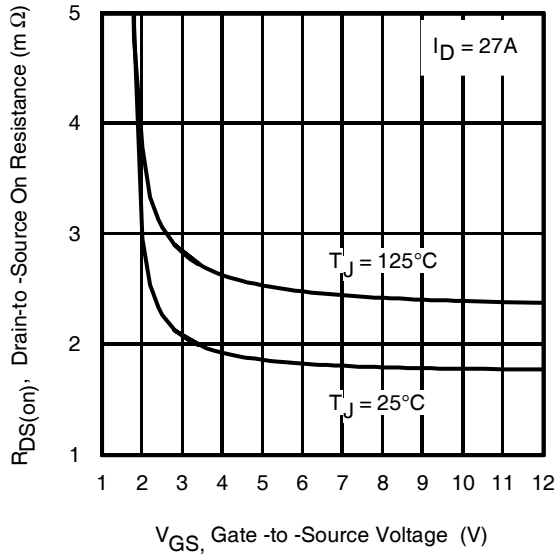

Fig 12. Typical On-Resistance vs. Gate Voltage

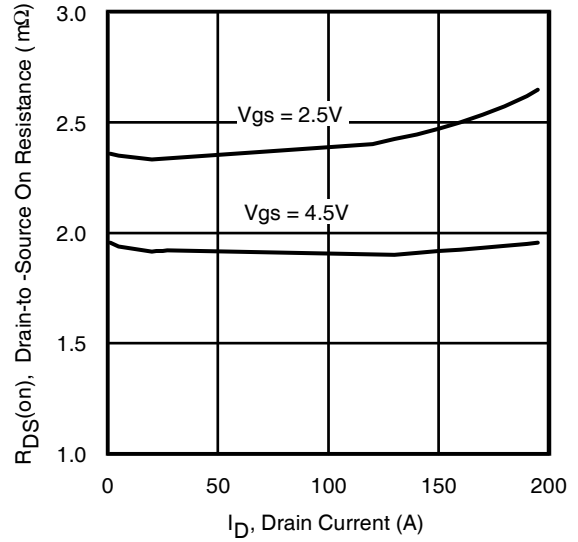

Fig 13. Typical On-Resistance vs. Drain Current

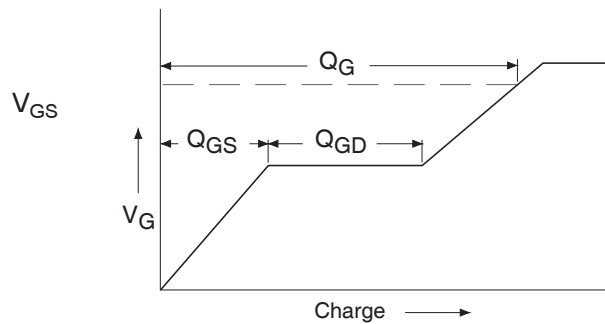

Fig 14a. Basic Gate Charge Waveform

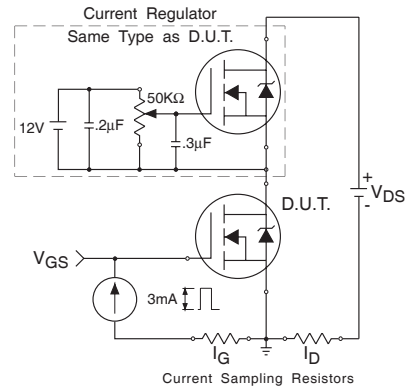

Fig 14b. Gate Charge Test Circuit

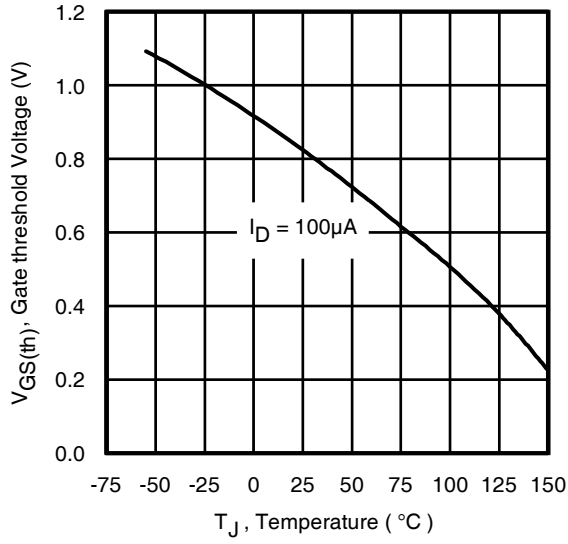

Fig 15. Typical Threshold Voltage vs. Junction Temperature

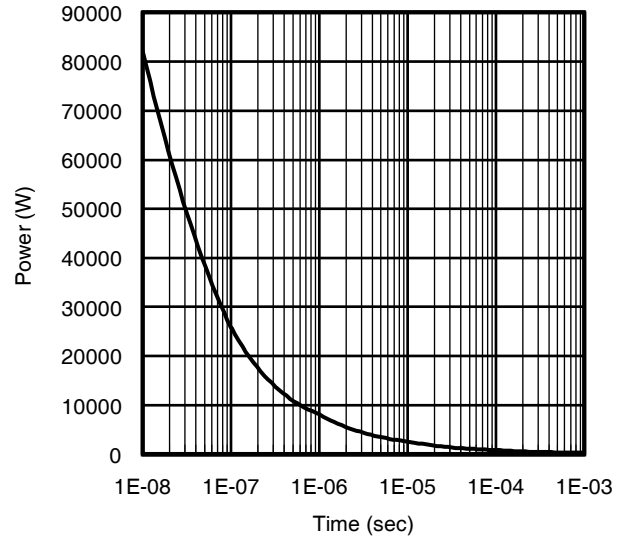
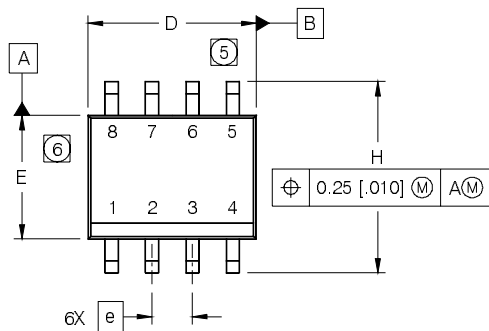

Fig 16. Typical Power vs. Time

IRF6201PbF

SO-8 Package Outline (Mosfet & Fetky)

Dimensions are shown in millimeters (inches)



DIM	INCHES		MILLIMETERS	
	MIN	MAX	MIN	MAX
A	.0532	.0688	1.35	1.75
A1	.0040	.0098	0.10	0.25
b	.013	.020	0.33	0.51
c	.0075	.0098	0.19	0.25
D	.189	.1968	4.80	5.00
E	.1497	.1574	3.80	4.00
e	.050 BASIC		1.27 BASIC	
e1	.025 BASIC		0.635 BASIC	
H	.2284	.2440	5.80	6.20
K	.0099	.0196	0.25	0.50
L	.016	.050	0.40	1.27
y	0°	8°	0°	8°

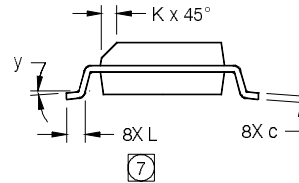
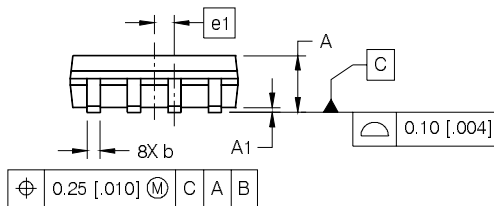

NOTES:

1. DIMENSIONING & TOLERANCING PER ASME Y14.5M-1994.
2. CONTROLLING DIMENSION: MILLIMETER
3. DIMENSIONS ARE SHOWN IN MILLIMETERS [INCHES].
4. OUTLINE CONFORMS TO JEDEC OUTLINE MS-012AA.
- ⑤ DIMENSION DOES NOT INCLUDE MOLD PROTRUSIONS. MOLD PROTRUSIONS NOT TO EXCEED 0.15 [0.006].
- ⑥ DIMENSION DOES NOT INCLUDE MOLD PROTRUSIONS. MOLD PROTRUSIONS NOT TO EXCEED 0.25 [0.010].
- ⑦ DIMENSION IS THE LENGTH OF LEAD FOR SOLDERING TO A SUBSTRATE.

FOOTPRINT

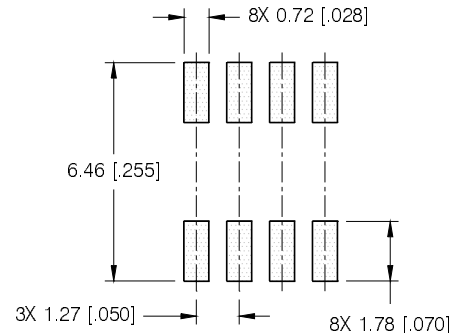

SO-8 Part Marking Information

EXAMPLE: THIS IS AN IRF7101 (MOSFET)

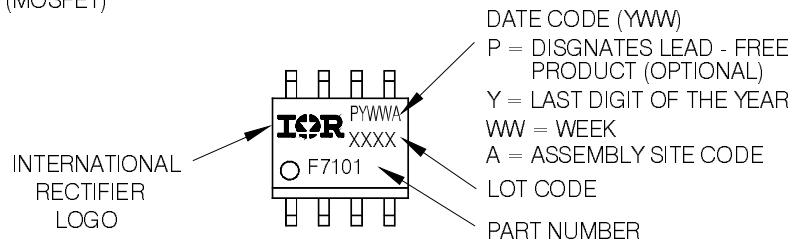

Note: For the most current drawing please refer to IR website at <http://www.irf.com/package/>

SO-8 Tape and Reel

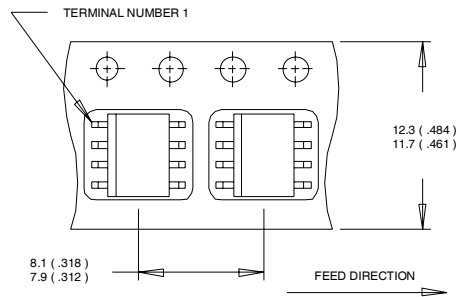

- NOTES:
1. CONTROLLING DIMENSION : MILLIMETER.
 2. ALL DIMENSIONS ARE SHOWN IN MILLIMETERS(INCHES).
 3. OUTLINE CONFORMS TO EIA-481 & EIA-541.

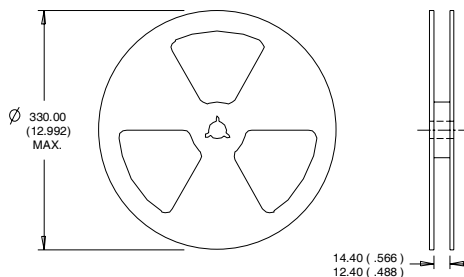

- NOTES :
1. CONTROLLING DIMENSION : MILLIMETER.
 2. OUTLINE CONFORMS TO EIA-481 & EIA-541.

Qualification Information[†]

Qualification level	Consumer ^{††} (per JEDEC JESD47F ^{†††} guidelines)	
Moisture Sensitivity Level	SO-8	MSL1 (per JEDEC J-STD-020D ^{†††})
RoHS Compliant	Yes	

[†] Qualification standards can be found at International Rectifier's web site

<http://www.irf.com/product-info/reliability>

^{††} Higher qualification ratings may be available should the user have such requirements.

Please contact your International Rectifier sales representative for further information:

<http://www.irf.com/whoto-call/salesrep/>

^{†††} Applicable version of JEDEC standard at the time of product release.

Data and specifications subject to change without notice.

International
IR Rectifier

IR WORLD HEADQUARTERS: 233 Kansas St., El Segundo, California 90245, USA Tel: (310) 252-7105

TAC Fax: (310) 252-7903

Visit us at www.irf.com for sales contact information. 11/10

Mouser Electronics

Authorized Distributor

Click to View Pricing, Inventory, Delivery & Lifecycle Information:

[Infineon:](#)

[IRF6201TRPBF](#) [IRF6201PBF](#)