



Part No: CEM-1212C

Description: magnetic buzzer

Date: 9/08/2006

Unit: mm

Page No: 1 of 5



Specifications

Rated voltage	12.0 V dc
Operating voltage	8.0 ~ 16.0 V dc
Current consumption	35 mA max.
Sound pressure level	85 db min. (94 db typ.) at 10 cm (A-weight free air)
Resonant frequency	2300 Hz ± 300
Operating temperature	-20 ~ +60° C
Storage temperature	-30 ~ +70° C
Dimensions	ø12 x H9.5 mm
Weight	1.6 g
Material	PPO (Black)
Terminal	Pin type (Au Plating)
RoHS	yes

Appearance Drawing

Tolerance: ±0.5

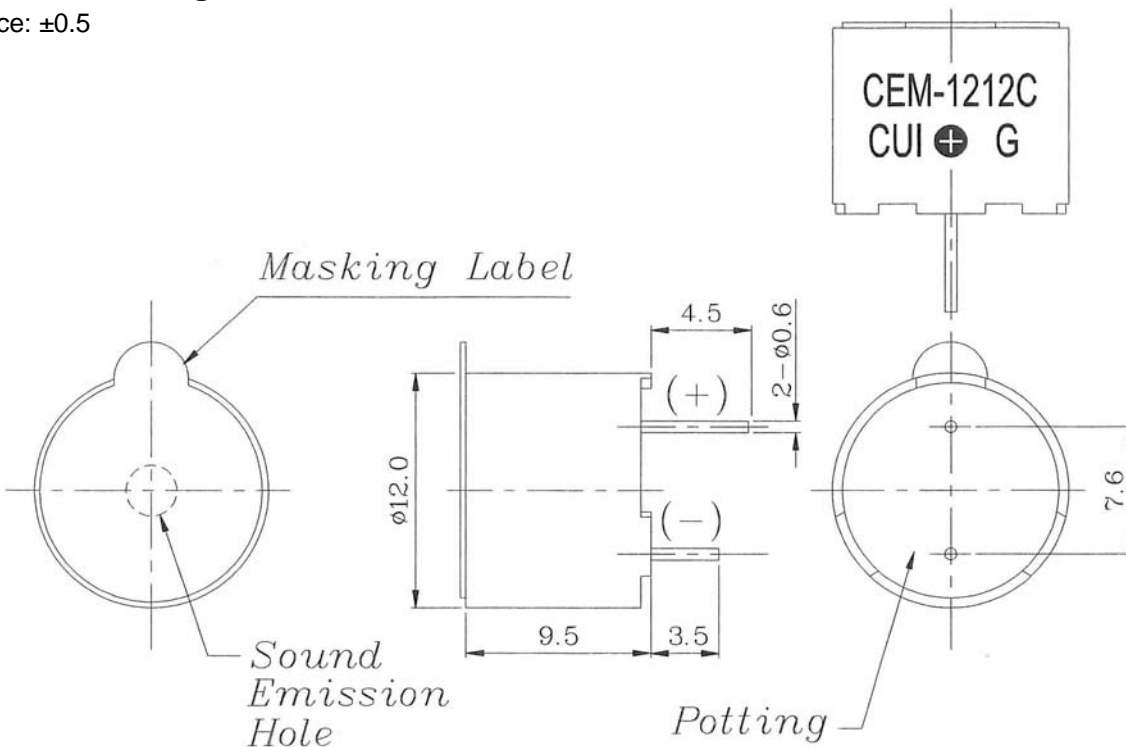



Part No: CEM-1212C

Description: magnetic buzzer

Date: 9/08/2006

Unit: mm

Page No: 2 of 5

Voltage: Sound Pressure Level / Voltage: Current Consumption

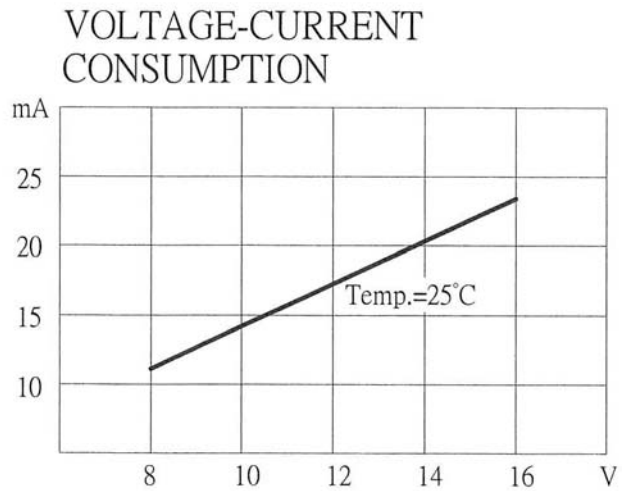
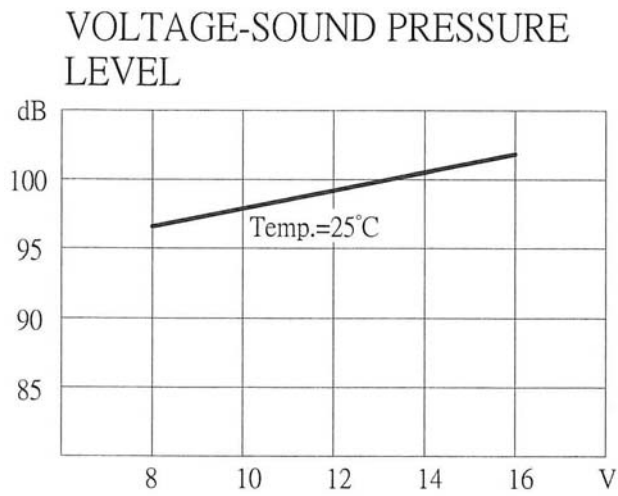

Measurement Method

+V DC

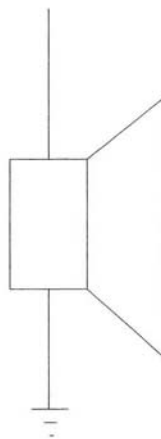



Part No: CEM-1212C

Date: 9/08/2006

Unit: mm

Description: magnetic buzzer

Page No: 3 of 5

Mechanical Characteristics

Item	Test Condition	Evaluation Standard
Solderability ¹	Lead terminals are immersed in rosin for 5 seconds and then immersed in solder bath of 270 ±5°C for 3 ±1 seconds.	90% min. of the lead terminals will be wet with solder. (Except the edge of the terminal.)
Soldering Heat Resistance	Lead terminals are immersed solder bath of 260 ±5°C for 3 ±1 seconds.	No interference in operation.
Terminal Mechanical Strength	For 10 seconds, the force of 9.8N (1.0kg) is applied to each terminal in axial direction.	No damage or cutting off.
Vibration	The buzzer should be measured after applying a vibration amplitude of 1.5mm with 10 to 55 Hz band of vibration frequency to each of the 3 perpendicular directions for 2 hours.	After the test, the part should meet specifications without any damage in appearance or performance. The SPL should be within ±10 dBA when compared to the initial measurement.
Drop Test	The part should be dropped from a height of 75 cm onto a 40 mm thick wooden board 3 times in 3 axes (X, Y, Z) for a total of 9 drops.	

Notes: 1. Not recommended for wave soldering

Environment Test

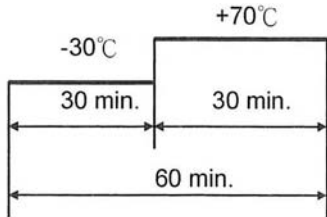
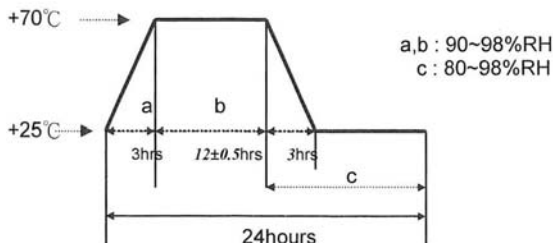
Item	Test Condition	Evaluation Standard
High temp. test	After being placed in a chamber at +70°C for 96 hours.	After the test, the part should meet specifications without any damage in appearance or performance. The SPL should be within ±10 dBA when compared to the initial measurement.
Low temp. test	After being placed in a chamber at -30°C for 96 hours.	
Thermal Shock	The part should be subjected to 10 cycles. One cycle will consist of: 	
Temp./Humidity cycle test	The part shall be subjected to 10 cycles. One cycle will be 24 hours and consist of: 	



Part No: CEM-1212C

Description: magnetic buzzer

Date: 9/08/2006

Unit: mm

Page No: 4 of 5

Reliability Tests

Item	Test Condition	Evaluation Standard
Operating (Life Test)	1. Continuous life test: The part will be subjected to 72 hours at 45°C with 12 V dc applied. 2. Intermittent life test: A duty cycle of 1 minute on, 1 minute off, a minimum of 10,000 times at room temp. (+25±10°C) with 12 V dc applied.	After the test, the part should meet specifications without any damage in appearance or performance. After 4 hours at +25°C, the SPL should be within ±10 dBA when compared to the initial measurement.

Test Conditions

Standard Test Condition	a) Temperature: +5 ~ +35°C	b) Humidity: 45 - 85%	c) Pressure: 860-1060 mbar
Judgement Test Condition	a) Temperature: +25 ±2°C	b) Humidity: 60 - 70%	c) Pressure: 860-1060 mbar



Part No: CEM-1212C

Description: magnetic buzzer

Date: 9/08/2006

Unit: mm

Page No: 5 of 5

Packaging

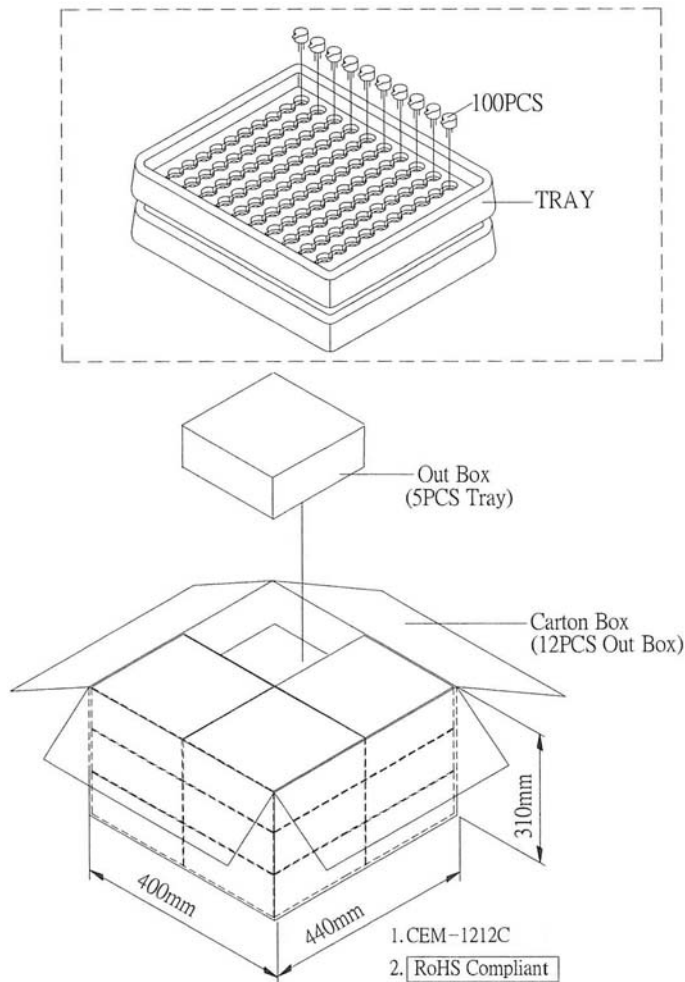

Tray	184mmx184mmx23mm	1x100PCS=100PCS
Out Box	200mmx190mmx100mm	5LAYERx100PCS=500PCS
Carton Box	440mmx400mmx310mm	500PCSx12=6,000PCS

Mouser Electronics

Authorized Distributor

Click to View Pricing, Inventory, Delivery & Lifecycle Information:

[CUI Inc.:](#)

[CEM-1212C](#)