



CM-SCE-TP Cable Marker

CM-SCE-TP Cable markers are flat, non-adhesive labels that can be used to identify large cables and wire bundles in particularly aggressive environments. Cable markers can be applied post cable termination using cable ties.

Manufactured using a specially developed radiation cross-linked flame retarded polymer. Typical installations include mass transit, Military and Aerospace.

These Cable markers are printed using Thermal transfer technology

KEY FEATURES

- Highly flame resistant - excellent resistance to burning (Oxygen Index 35%)
- Resistant to key industrial and military grade fluids (defined by RW-2513)

APPLICATIONS

- Post termination cable identification
- Identification of large cables, wire bundles or pipework
- Installation friendly – easy to replace, ideal for retrofitting and repairs. Only cable ties wraps are needed
- Mass transit, Rail, Aerospace, Marine, Military and Industrial

PRINTER INFORMATION

Print Quality and Print Performance can only be guaranteed when specific TE printer and ribbons are used

The current list of printers and ribbons can be found in TE document 411-121005 '**Identification Printer Product Ribbon Matrix**'

This document can be found at the TE document repository:

<http://www.te.com/commerce/DocumentDelivery/DDEController>

TEMPERATURE RATING

Operating Temperature Range -55°C to 135°C (-67°F to 275°F)

ENVIRONMENTAL

The Cable marker, including the print, does not promote mould growth (ASTM G21 / 28 days – zero rating)

Does not migrate substances which will damage or corrode the surrounding environment, including the conductor

Further information and a downloadable declaration covering RoHS and REACH compliance can be found at the 'TE Product Compliance Support Centre':

<http://www.te.com/en/resources/product-compliance.html>

SPECIFICATIONS / APPROVALS

TE Connectivity Standard

- RW-2513

Industry

- UL Certification MH26328 Group PG1S2

Mass Transit

- EN45545-2 'Hazard Classification 3' Requirement Set R24

SOFTWARE

Cable Markers are fully supported by WINTOTAL and PrintEasy label printing software, available from the TE product store:

<http://www.te.com/en/general/label-printing-software.html>

Contact a TE representative for further information

Where possible, TE have tested product as a finished item, including the print. Operational tests are followed by an assessment of mark adherence to validate fit form and function. Further details can be found in TE standard RW-2513

ORDERING INFORMATION

CM-SCE-TP Cable Marker

PART DESCRIPTION

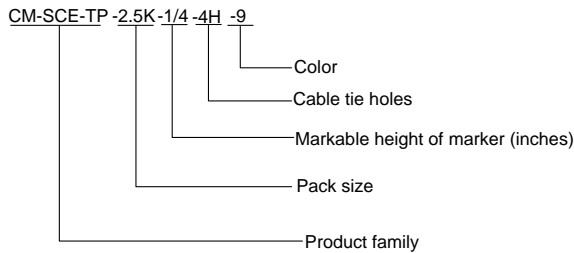

OPTIONS

Cable marker size

- ¼ or ½ inch

Cable tie holes

- 4 or 6

Pack sizes

- 250 or 2500 (2.5k) pieces

Color

- White standard (-9) or Yellow non-standard (-4)

ORDERING INFORMATION: Specify product family, pack size, markable height, number of cable tie holes and color.

AVAILABLE FORMATS

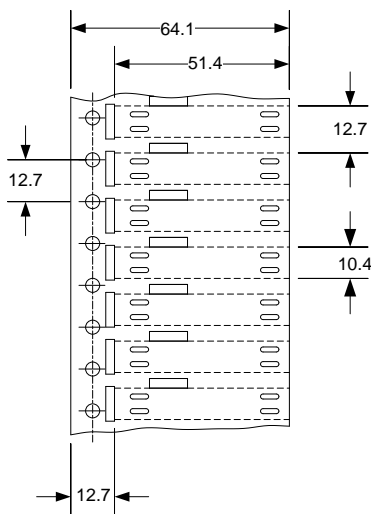

CM-SCE-TP-1/4-4H

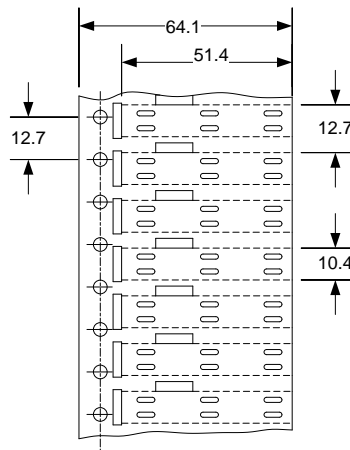

CM-SCE-TP-1/4-6H

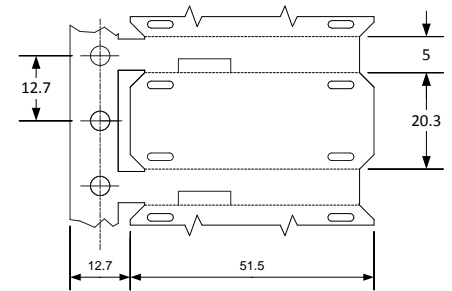

CM-SCE-TP-1/2-4H

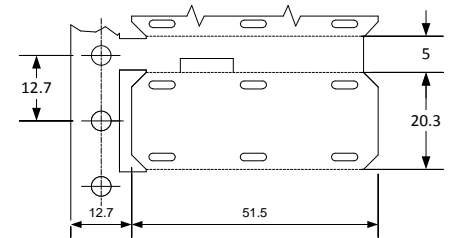

CM-SCE-TP-1/2-6H

Dimensions in mm

Part Description	Markable height		Markable length		Recommended cable use range	
	mm	inches	mm	inches	mm	inches
CM-SCE-TP-1/4-	6.4	0.25	50.8	2	5.08 - 12.5	0.2 - 0.492
CM-SCE-TP-1/2-	12.7	0.50	50.8	2	12.5 and up	0.492 and up

While TE has made every reasonable effort to ensure the accuracy of the information in this document, TE does not guarantee that it is error-free, nor does TE make any other representation, warranty or guarantee that the information is accurate, correct, reliable or current. TE reserves the right to make any adjustments to the information contained herein at any time without notice. TE expressly disclaims all implied warranties regarding the information contained herein, including, but not limited to, any implied warranties of merchantability or fitness for a particular purpose. The dimensions in this document are for reference purposes only and are subject to change without notice. Specifications are subject to change without notice. Consult TE for the latest dimensions and design specifications.

*Trademark. TE Connectivity, TE connectivity (logo), and TE (logo) are trademarks. Other logos, product and/or company names may be trademarks of their respective owners.

Mouser Electronics

Authorized Distributor

Click to View Pricing, Inventory, Delivery & Lifecycle Information:

[TE Connectivity:](#)

[CM-SCE-TP-1/4-4H-9](#)