

SERIES KO SWITCHES

KEYLOCK SWITCHES

TACT SWITCHES

NAVIGATION SWITCHES

PUSHBUTTON SWITCHES

TOGGLE SWITCHES

ROCKER SWITCHES

SLIDE SWITCHES

SNAP-ACTION SWITCHES

DIP SWITCHES

KEYLOCK SWITCHES

ROTARY SWITCHES

DETECTOR SWITCHES

CAP OPTIONS



SPECIFICATIONS

Contact Rating:	As per individual model number
Initial Contact Resistance:	10 mΩ Max.
Insulation Resistance:	As per individual model number
Dielectric Strength:	As per individual model number

MATERIALS

Housing and Cylinder:	Die cast zinc alloy. Finish dependent upon individual model number
Contact:	Silver plated copper alloy
Keys:	As per individual model number

FEATURES & BENEFITS

- ▶ Variety of size and product package options
- ▶ Barrel and flat key options
- ▶ Wide variety of key code options

APPLICATIONS/MARKETS

- ▶ Security applications
- ▶ Personal transportation vehicles
- ▶ Elevator controls



HOW TO ORDER



Example Ordering Number
KO-103B

Specifications subject to change without notice.

KO 103

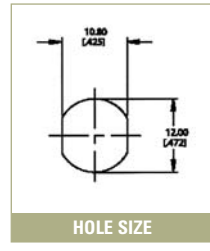
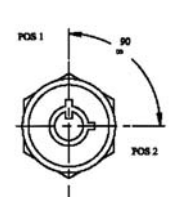
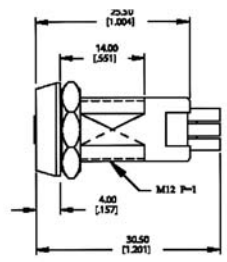

FEATURES & BENEFITS

- ▶ Zinc alloy die cast housing and cylinder, chrome plated
- ▶ Zinc alloy keys, chrome plated
- ▶ Silver plated contacts and terminals
- ▶ 200 combinations available

SPECIFICATIONS

Ratings:	1A @ 125 VAC 0.5A @ 250 VAC
Contact Resistance:	20 mΩ max. initial @ 2-4 VDC, 100 mA
Insulation Resistance:	200 MΩ min.
Dielectric Strength:	1,500 V rms @ sea level

Part Number	Lock Configuration (as viewed from key end)	Connected Terminals			Key Pull Possible
		Pos. 1	Pos. 2	Pos. 3	
KO103A	90° indexing	OFF	1-2		Pos. 1
KO103B	90° indexing	OFF	1-2		Pos. 1, Pos. 2
KO103C	90° indexing	1-2	3-4		Pos. 1
KO103D	90° indexing	1-2	3-4		Pos. 1, Pos. 2
KO103E	90° indexing	OFF	1-2		Pos. 1

• = Detent Position ◯ = Keypull Possible ▼ = Momentary

KO 104

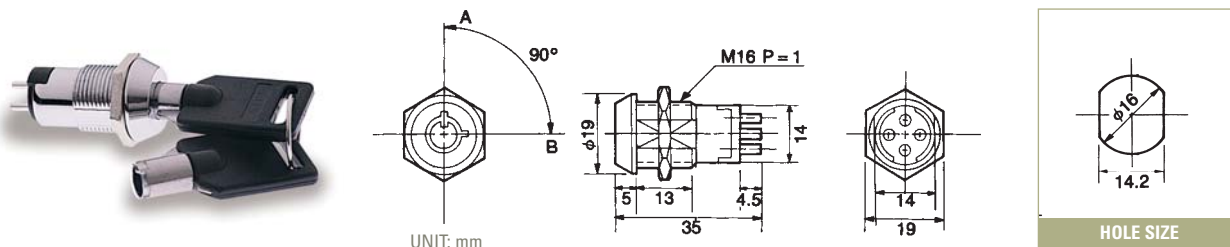



FEATURES & BENEFITS

- ▶ Zinc alloy die cast housing and cylinder, chrome plated
- ▶ Zinc alloy keys, chrome plated, with plastic cover
- ▶ Silver plated contacts and terminals
- ▶ 10,000 combinations available

SPECIFICATIONS

Ratings:	3A @ 125 VAC 1.5A @ 250 VAC
Contact Resistance:	20 mΩ max. initial @ 2-4 VDC, 100 mA
Insulation Resistance:	200 MΩ min.
Dielectric Strength:	1,500 V rms @ sea level

Part Number	Lock Configuration (as viewed from key end)	Connected Terminals			Key Pull Possible
		Pos. 1	Pos. 2	Pos. 3	
KO104A	 90° indexing	1-2	3-4		Pos. 1
KO104B	 90° indexing	1-2	3-4		Pos. 1, Pos. 2

• = Detent Position ◉ = Keypull Possible ▼ = Momentary

KO 105

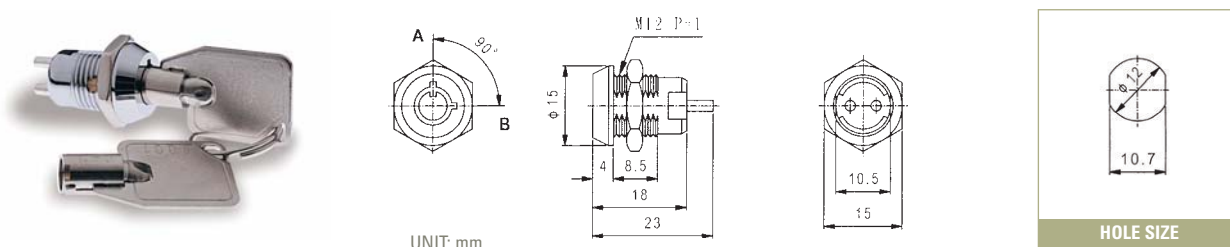



FEATURES & BENEFITS

- ▶ Zinc alloy die cast housing and cylinder, chrome plated
- ▶ Steel made tubular keys, nickel plated, with plastic cover
- ▶ Silver plated contacts and terminals
- ▶ 100 combinations available

SPECIFICATIONS

Ratings:	1A @ 125 VAC 0.5A @ 250 VAC
Contact Resistance:	20 mΩ max. initial @ 2-4 VDC, 100 mA
Insulation Resistance:	200 MΩ min.
Dielectric Strength:	1,500 V rms @ sea level

Part Number	Lock Configuration (as viewed from key end)	Connected Terminals			Key Pull Possible
		Pos. 1	Pos. 2	Pos. 3	
KO105A	 90° indexing	OFF	1-2		Pos. 1, Pos. 2
KO105B	 90° indexing	1-2	3-4		Pos. 1, Pos. 2

• = Detent Position ◉ = Keypull Possible ▼ = Momentary

SERIES KO SWITCHES

KEYLOCK SWITCHES

KO 106

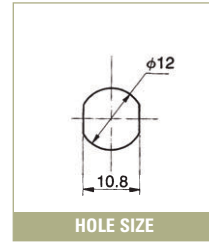
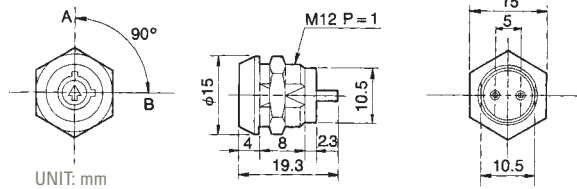

FEATURES & BENEFITS

- ▶ Zinc alloy die cast housing and cylinder, chrome plated
- ▶ Zinc alloy keys, chrome plated
- ▶ Silver plated contacts and terminals
- ▶ 1 combination available

SPECIFICATIONS

Ratings:	1A @ 125 VAC 0.5A @ 250 VAC
Contact Resistance:	20 mΩ max. initial @ 2-4 VDC, 100 mA
Insulation Resistance:	200 MΩ min.
Dielectric Strength:	1,500 V rms @ sea level

Part Number	Lock Configuration (as viewed from key end)	Connected Terminals			Key Pull Possible
		Pos. 1	Pos. 2	Pos. 3	
KO106A	90° indexing	OFF	1-2		Pos. 1, Pos. 2

• = Detent Position ◯ = Keypull Possible ▼ = Momentary

KO 107

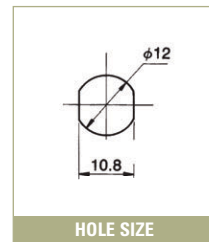
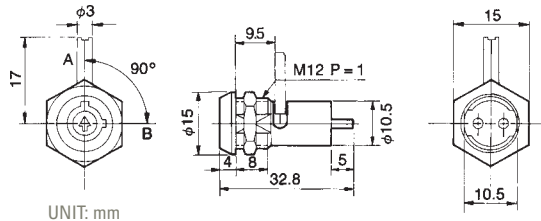

FEATURES & BENEFITS

- ▶ Zinc alloy die cast housing and cylinder, chrome plated
- ▶ Zinc alloy keys, chrome plated
- ▶ Silver plated contacts and terminals
- ▶ L dimension per customer requirement, 13 mm is standard
- ▶ 6 combinations available

SPECIFICATIONS

Ratings:	1A @ 125 VAC 0.5A @ 250 VAC
Contact Resistance:	20 mΩ max. initial @ 2-4 VDC, 100 mA
Insulation Resistance:	200 MΩ min.
Dielectric Strength:	1,500 V rms @ sea level

Part Number	Lock Configuration (as viewed from key end)	Connected Terminals			Key Pull Possible
		Pos. 1	Pos. 2	Pos. 3	
KO107A	90° indexing	OFF	1-2		Pos. 1, Pos. 2

• = Detent Position ◯ = Keypull Possible ▼ = Momentary

KO 113

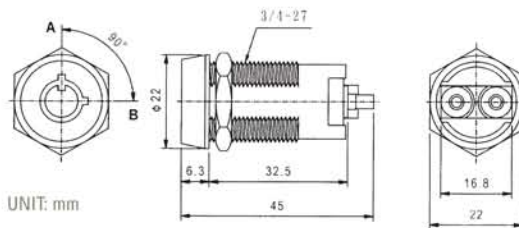

UNIT: mm

HOLE SIZE

FEATURES & BENEFITS

- ▶ Zinc alloy die cast housing and cylinder, chrome plated
- ▶ Steel made tubular keys, nickel plated,
- ▶ Silver plated contacts and terminals
- ▶ 50,000 combinations available

SPECIFICATIONS

Ratings:	4A @ 125 VAC 2A @ 250 VAC
Contact Resistance:	20 mΩ max. initial @ 2-4 VDC, 100 mA
Insulation Resistance:	200 MΩ min.
Dielectric Strength:	1,500 V rms @ sea level

Part Number	Lock Configuration (as viewed from key end)	Connected Terminals			Key Pull Possible
		Pos. 1	Pos. 2	Pos. 3	
KO113A	⊙, 90° indexing	OFF	1-2		Pos. 1
KO113B	⊙, 90° indexing	OFF	1-2		Pos. 1, Pos. 2
KO113C	⊙, 90° indexing	OFF	1-2		Pos. 1

• = Detent Position ⊙ = Keypull Possible ▼ = Momentary

KO 114

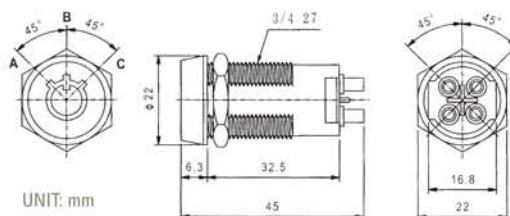

UNIT: mm

HOLE SIZE

FEATURES & BENEFITS

- ▶ Zinc alloy die cast housing and cylinder, chrome plated
- ▶ Steel made tubular keys, nickel plated
- ▶ Silver plated contacts and terminals
- ▶ 50,000 combinations available

SPECIFICATIONS

Ratings:	4A @ 125 VAC 2A @ 250 VAC
Contact Resistance:	20 mΩ max. initial @ 2-4 VDC, 100 mA
Insulation Resistance:	200 MΩ min.
Dielectric Strength:	1,500 V rms @ sea level

Part Number	Lock Configuration (as viewed from key end)	Connected Terminals			Key Pull Possible
		Pos. 1	Pos. 2	Pos. 3	
KO114A	⊙, 45°-45° indexing	1-3	OFF	2-4	Pos. 1, Pos. 2, Pos. 3
KO114B	⊙, 45°-90° indexing	OFF	1-3	2-4	Pos. 1, Pos. 2, Pos. 3
KO114C	⊙, 90° indexing	1-3	2-4		Pos. 1, Pos. 2
KO114D	⊙, 45° indexing	OFF	1-3, 2-4		Pos. 1, Pos. 2

• = Detent Position ⊙ = Keypull Possible ▼ = Momentary

SERIES KO SWITCHES

KEYLOCK SWITCHES

TACT SWITCHES

NAVIGATION SWITCHES

PUSHBUTTON SWITCHES

TOGGLE SWITCHES

ROCKER SWITCHES

SLIDE SWITCHES

SNAP-ACTION SWITCHES

DIP SWITCHES

KEYLOCK SWITCHES

ROTARY SWITCHES

DETECTOR SWITCHES

CAP OPTIONS

KO 117

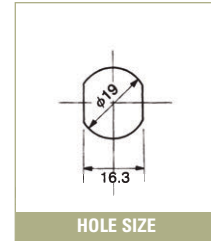
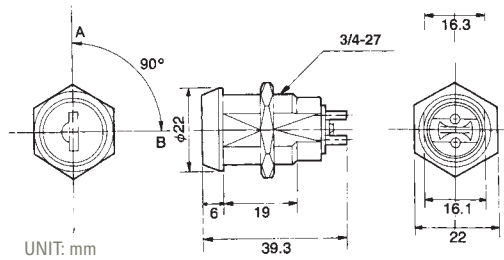

FEATURES & BENEFITS

- ▶ Zinc alloy die cast housing, chrome plated
- ▶ 5-Disk tumblers mechanism, with dust shutter
- ▶ Reversible double cut key, brass made, nickel plated
- ▶ Silver plated contacts and terminals
- ▶ 150 combinations available

SPECIFICATIONS

Ratings:	4A @ 125 VAC 2A @ 250 VAC
Contact Resistance:	20 mΩ max. initial @ 2-4 VDC, 100 mA
Insulation Resistance:	200 MΩ min.
Dielectric Strength:	1,500 V rms @ sea level

Part Number	Lock Configuration (as viewed from key end)	Connected Terminals			Key Pull Possible
		Pos. 1	Pos. 2	Pos. 3	
KO117A	$\overset{1}{\odot} \underset{2}{\ominus} 90^\circ$ indexing	OFF	1-2		Pos. 1, Pos. 2

• = Detent Position ◯ = Keypull Possible ▼ = Momentary

KO 118

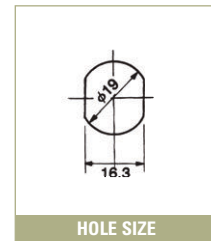
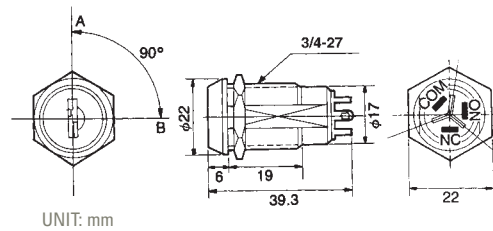

FEATURES & BENEFITS

- ▶ Zinc alloy die cast housing, chrome plated
- ▶ 5-Disk tumblers mechanism, with dust shutter
- ▶ Reversible double cut key, brass made, nickel plated
- ▶ Silver plated contacts and terminals
- ▶ 150 combinations available

SPECIFICATIONS

Ratings:	4A @ 125 VAC 2A @ 250 VAC
Contact Resistance:	20 mΩ max. initial @ 2-4 VDC, 100 mA
Insulation Resistance:	200 MΩ min.
Dielectric Strength:	1,500 V rms @ sea level

Part Number	Lock Configuration (as viewed from key end)	Connected Terminals			Key Pull Possible
		Pos. 1	Pos. 2	Pos. 3	
KO118A	$\overset{1}{\odot} \underset{2}{\ominus} 90^\circ$ indexing	1-2	3-4		Pos. 1, Pos. 2

• = Detent Position ◯ = Keypull Possible ▼ = Momentary

KO 119

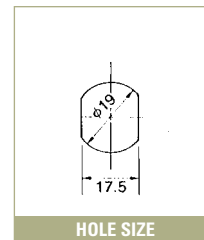
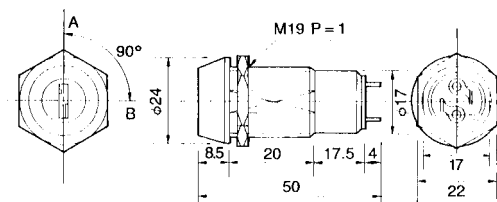



FEATURES & BENEFITS

- ▶ Zinc alloy die cast housing and cylinder
- ▶ 5-Disk tumblers mechanism
- ▶ Reversible double cut key
- ▶ Silver plated contacts and terminals
- ▶ 150 combinations available

SPECIFICATIONS

Ratings:	4A @ 125 VAC 2A @ 250 VAC
Contact Resistance:	20 mΩ max. initial @ 2-4 VDC, 100 mA
Insulation Resistance:	200 MΩ min.
Dielectric Strength:	1,500 V rms @ sea level

Part Number	Lock Configuration (as viewed from key end)	Connected Terminals			Key Pull Possible
		Pos. 1	Pos. 2	Pos. 3	
KO119A	 90° indexing	OFF	1-2		Pos. 1
KO119B	 90° indexing	OFF	1-2		Pos. 1, Pos. 2
KO119C	 90° indexing	OFF	1-2		Pos. 1

• = Detent Position ⊙ = Keypull Possible ▼ = Momentary

KO 121

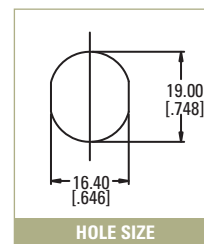
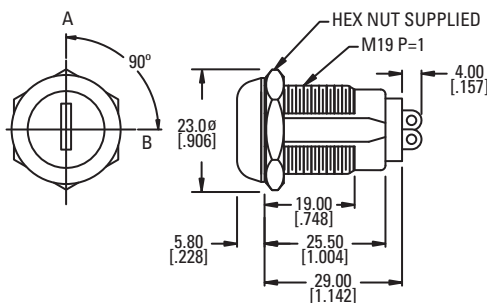

FEATURES & BENEFITS

- ▶ Zinc alloy die cast housing with bright stainless steel bezel
- ▶ 5-Disk tumblers mechanism, with dust shutter
- ▶ 150 combinations available

SPECIFICATIONS

Ratings:	4A @ 125 VAC 2A @ 250 VAC
Contact Resistance:	20 mΩ max. initial @ 2-4 VDC, 100 mA
Insulation Resistance:	200 MΩ min.
Dielectric Strength:	1,500 V rms @ sea level

Part Number	Lock Configuration (as viewed from key end)	Connected Terminals			Key Pull Possible
		Pos. 1	Pos. 2	Pos. 3	
KO121A	 90° indexing	OFF	1-2		Pos. 1, Pos. 2

• = Detent Position ⊙ = Keypull Possible ▼ = Momentary

SERIES KO SWITCHES

KEYLOCK SWITCHES

KO 124

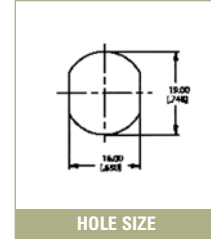
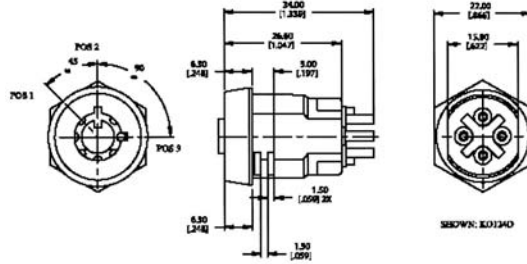

FEATURES & BENEFITS

- ▶ Zinc alloy die cast housing and cylinder, satin chrome plated
- ▶ Steel made tubular keys, nickel plated
- ▶ Silver plated contacts and terminals
- ▶ 50,000 combinations available

SPECIFICATIONS

Ratings:	2A @ 125 VAC 1A @ 250 VAC
Contact Resistance:	20 mΩ max. initial @ 2-4 VDC, 100 mA
Insulation Resistance:	200 MΩ min.
Dielectric Strength:	1,500 V rms @ sea level

Part Number	Lock Configuration (as viewed from key end)	Connected Terminals				Key Pull Possible
		Pos. 1	Pos. 2	Pos. 3	Pos. 4	
KO124A	90° indexing		OFF	1-2		Pos. 2, Pos. 3
KO124C	90° indexing		1-2	3-4		Pos. 2, Pos. 3
KO124D	45°/90° indexing	OFF	1-2	3-4		Pos. 1, Pos. 2, Pos. 3

• = Detent Position ◯ = Keypull Possible ▼ = Momentary

KO 126

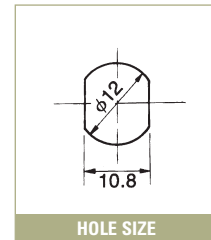
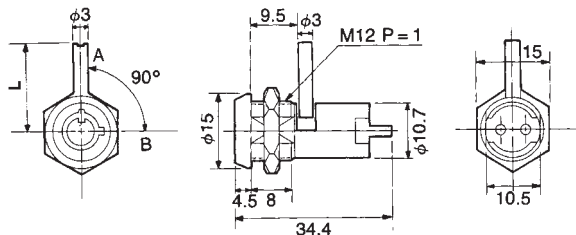

FEATURES & BENEFITS

- ▶ Zinc alloy die cast housing, chrome plated
- ▶ Brass cylinder, chrome plated
- ▶ Brass keys, nickel plated, with plastic cover
- ▶ Silver plated contacts and terminals
- ▶ 2 positions (Off-On)
- ▶ Dual-Functioned Key Lock Switch
- ▶ L dimension per customer requirement; 13mm is standard
- ▶ 200 combinations available

SPECIFICATIONS

Ratings:	1A @ 125 VAC 0.5A @ 250 VAC
Contact Resistance:	20 mΩ max. initial @ 2-4 VDC, 100 mA
Insulation Resistance:	200 MΩ min.
Dielectric Strength:	1,500 V rms @ sea level

Part Number	Lock Configuration (as viewed from key end)	Connected Terminals				Key Pull Possible
		Pos. 1	Pos. 2	Pos. 3	Pos. 4	
KO126A	90° indexing	OFF	1-2			Pos. 1, Pos. 2

• = Detent Position ◯ = Keypull Possible ▼ = Momentary

KO 128

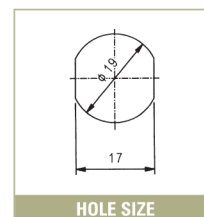
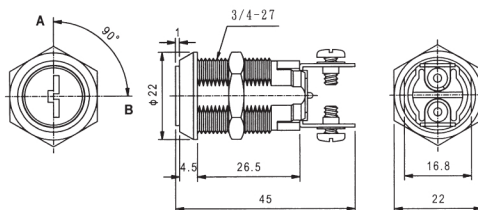

FEATURES & BENEFITS

- ▶ Zinc alloy die cast housing and cylinder, chrome plated
- ▶ 11 Blade criss cross tumblers.
- ▶ Reversible, double bitted keys

SPECIFICATIONS

Ratings:	4A @ 125 VAC 2A @ 250 VAC
Contact Resistance:	20 mΩ max. initial @ 2-4 VDC, 100 mA
Insulation Resistance:	200 MΩ min.
Dielectric Strength:	1,500 V rms @ sea level

Part Number	Lock Configuration (as viewed from key end)	Connected Terminals				Key Pull Possible
		Pos. 1	Pos. 2	Pos. 3	Pos. 4	
KO128A	90° indexing	OFF	1-2			Pos. 1
KO128B	90° indexing	OFF	1-2			Pos. 1, Pos. 2
KO128E	90° indexing	OFF	1-2			Pos. 1
KO128F	90° indexing	OFF	1-2			Pos. 1
KO128G	90° indexing	OFF	1-2			Pos. 1, Pos. 2
KO128H	90° indexing	OFF	1-2			Pos. 1

• = Detent Position ⊕ = Keypull Possible ▼ = Momentary

KO 129

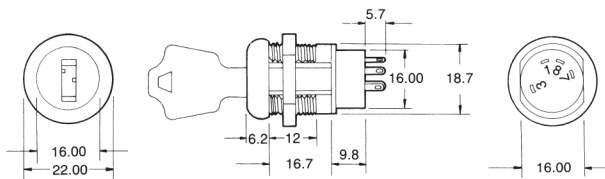

FEATURES & BENEFITS

- ▶ Lock: bright nickel plated zinc alloy with nickel facing (black and polished chrome facing available)
- ▶ Tumbler mechanism: 4-disc tumbler cylinder
- ▶ Keys: brass with code no.
- ▶ Contacts: silver plated copper alloy
- ▶ Terminals: silver plated copper alloy
- ▶ Mounting nut: nickel plated zinc alloy



SPECIFICATIONS

Ratings:	4A @ 125 VAC 2A @ 250 VAC
Contact Resistance:	20 mΩ max. initial @ 2-4 VDC, 100 mA
Insulation Resistance:	200 MΩ min.
Dielectric Strength:	1,500 V rms @ sea level

Part Number	Lock Configuration (as viewed from key end)	Connected Terminals					Key Pull Possible
		Pos. 1	Pos. 2	Pos. 3	Pos. 4	Pos. 5	
KO129A (SP)	45°-90° indexing		7-8	8-1		1-3	Pos. 3, Pos. 5
KO129B (SP)	90°-45° indexing	7-1	1-2	6-7			Pos. 1, Pos. 3
KO129C (SP)	45°-45° indexing		1-2	8-1	7-8		Pos. 3
KO129D (DP)	45°-45° indexing		1-2, 5-6	8-1, 4-5	7-8, 3-4		Pos. 3
KO129E (SP)	45° indexing			8-1	1-2		Pos. 3
KO129F (DP)	45° indexing			8-1, 4-5	1-2, 5-6		Pos. 3
KO129G (SP)	45° indexing		7-8	8-1			Pos. 3
KO129H (DP)	45° indexing		7-8, 3-4	8-1, 4-5			Pos. 3
KO129J (SP)	45°-45° indexing		1-2	8-1	7-8		Pos. 3
KO129K (DP)	45°-45° indexing		1-2, 5-6	8-1, 4-5	7-8, 3-4		Pos. 3
KO129L (SP)	45°-45° indexing		7-8	8-1	1-2		Pos. 3
KO129M (DP)	45°-45° indexing		7-8, 3-4	8-1, 4-5	1-2, 5-6		Pos. 3

• = Detent Position ⊕ = Keypull Possible ▼ = Momentary

SERIES KO SWITCHES

KEYLOCK SWITCHES

KO 130

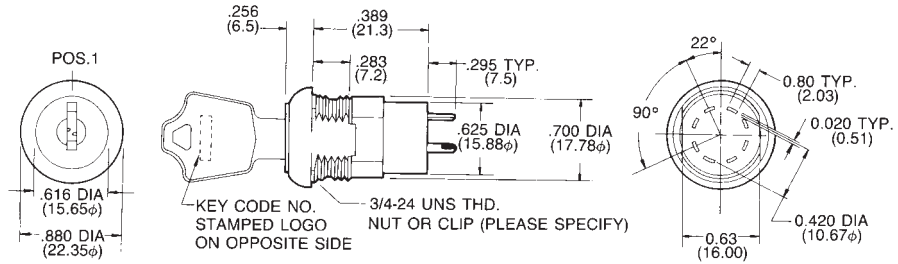

FEATURES & BENEFITS

- ▶ Lock: bright nickel plated zinc alloy with nickel facing (black and polished chrome facing available)
- ▶ Tumbler mechanism: 4-disc tumbler cylinder
- ▶ Keys: brass with code no.
- ▶ Contacts: silver plated copper alloy
- ▶ Terminals: silver plated copper alloy
- ▶ Contact spring: piano wire
- ▶ Mounting nut: nickel plated zinc alloy



SPECIFICATIONS

Ratings:	4A @ 125 VAC 2A @ 250 VAC
Contact Resistance:	20 mΩ max. initial @ 2-4 VDC, 100 mA
Insulation Resistance:	200 MΩ min.
Dielectric Strength:	1,500 V rms @ sea level

*Anti-static models exceed 20kv DC static resistance also available

Part Number	Lock Configuration (as viewed from key end)	Connected Terminals					Key Pull Possible
		Pos. 1	Pos. 2	Pos. 3	Pos. 4	Pos. 5	
KO130A (SP)	45°-45° indexing			8-1	1-2	2-3	Pos. 3
KO130B (DP)	45°-45° indexing			8-1, 4-5	1-2, 5-6	2-3, 6-7	
KO130C (SP)	45°-45° indexing			8-1	1-2	2-3	Pos. 5
KO130D (DP)	45°-45° indexing			8-1, 4-5	1-2, 5-6	2-3, 6-7	
KO130E (SP)	45°-45° indexing			8-1	1-2	2-3	Pos. 3, Pos. 5
KO130F (DP)	45°-45° indexing			8-1, 4-5	1-2, 5-6	2-3, 6-7	
KO130G (SP)	45°-45° indexing		8-1	1-2	7-8		Pos. 3
KO130H (DP)	45°-45° indexing		8-1, 4-5	1-2, 5-6	7-8, 3-4		
KO130I (SP)	45°-45° indexing		8-1	1-2	7-8		Pos. 2, Pos. 3, Pos. 4
KO130J (DP)	45°-45° indexing		8-1, 4-5	1-2, 5-6	7-8, 3-4		
KO130K (SP)	45°-45°-45°-45° indexing	6-7	7-8	8-1	1-2	2-3	Pos. 3
KO130L (SP)	45°-45°-45°-45° indexing	6-7	7-8	8-1	1-2	2-3	
KO130M (SP)	45°-45°-45°-45° indexing	6-7	7-8	8-1	1-2	2-3	Pos. 1, Pos. 3, Pos. 5
KO130N (SP)	90° indexing			8-1		1-3	
KO130O (DP)	90° indexing			8-1, 4-5		1-3, 5-7	Pos. 3
KO130P (SP)	90° indexing			8-1		1-3	
KO130Q (DP)	90° indexing			8-1, 4-5		1-3, 5-7	Pos. 5
KO130R (SP)	90° indexing			8-1		1-3	
KO130S (DP)	90° indexing			8-1, 4-5		1-3, 5-7	Pos. 3, Pos. 5
KO130T (SP)	45°-45°-90° indexing	6-7	7-8	8-1		1-3	
KO130U (SP)	45°-45°-90° indexing	6-7	7-8	8-1		1-3	Pos. 1, Pos. 5
KO130V (SP)	45°-45°-90° indexing	6-7	7-8	8-1		1-3	
KO130Y (SP)	90°-45°-45° indexing	6-7		7-1	1-2	2-3	Pos. 3
KO130Z (SP)	90°-45°-45° indexing	6-7		7-1	1-2	2-3	
KO130Z1 (SP)	90°-45°-45° indexing	6-7		7-1	1-2	2-3	Pos. 1, Pos. 3, Pos. 5
KO130Z2 (SP)	90°-90° indexing	6-7		7-1		1-3	
KO130Z3 (SP)	90°-90° indexing	6-7		7-1		1-3	Pos. 1, Pos. 5
KO130Z4 (SP)	90°-90° indexing	6-7		7-1		1-3	

• = Detent Position ⊙ = Keypull Possible ▼ = Momentary

KO 131

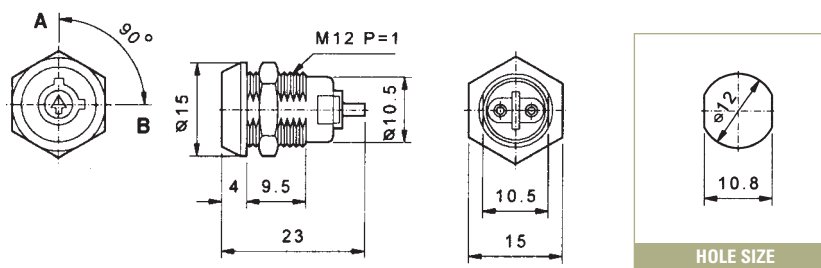

FEATURES & BENEFITS

- ▶ Zinc alloy die cast housing and cylinder, chrome plated
- ▶ Zinc alloy keys, chrome plated
- ▶ Silver plated contacts and terminals
- ▶ 1 combination available

SPECIFICATIONS

Ratings:	1A @ 125 VAC
	0.5A @ 250 VAC
Contact Resistance:	20 mΩ max. initial @ 2-4 VDC, 100 mA
Insulation Resistance:	200 MΩ min.
Dielectric Strength:	1,500 V rms @ sea level

Part Number	Lock Configuration (as viewed from key end)	Connected Terminals				Key Pull Possible
		Pos. 1	Pos. 2	Pos. 3	Pos. 4	
KO131A	90° indexing	OFF	1-2			Pos. 1, Pos. 2

• = Detent Position ⊙ = Keypull Possible ▼ = Momentary

KO 132

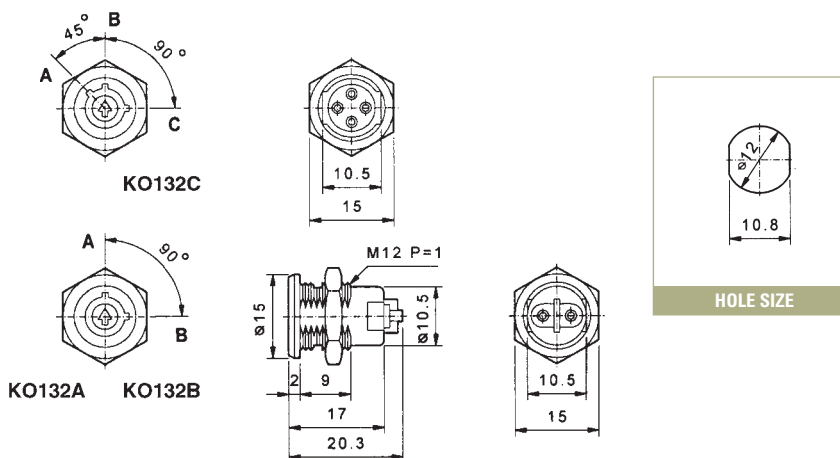

FEATURES & BENEFITS

- ▶ Zinc alloy die cast housing and cylinder, chrome plated
- ▶ Zinc alloy keys, chrome plated
- ▶ Silver plated contacts and terminals
- ▶ 6 combination available

SPECIFICATIONS

Ratings:	1A @ 125 VAC
	0.5A @ 250 VAC
Contact Resistance:	20 mΩ max. initial @ 2-4 VDC, 100 mA
Insulation Resistance:	200 MΩ min.
Dielectric Strength:	1,500 V rms @ sea level

Part Number	Lock Configuration (as viewed from key end)	Connected Terminals				Key Pull Possible
		Pos. 1	Pos. 2	Pos. 3	Pos. 4	
KO132A	90° indexing		OFF	1-2		Pos. 1, Pos. 2
KO132B	90° indexing			1-2	3-4	Pos. 1, Pos. 2
KO132C	45°-90° indexing	OFF	1-2		3-4	Pos. 1, Pos. 2, Pos. 3

• = Detent Position ⊙ = Keypull Possible ▼ = Momentary

SERIES KO SWITCHES

KEYLOCK SWITCHES

KO 133

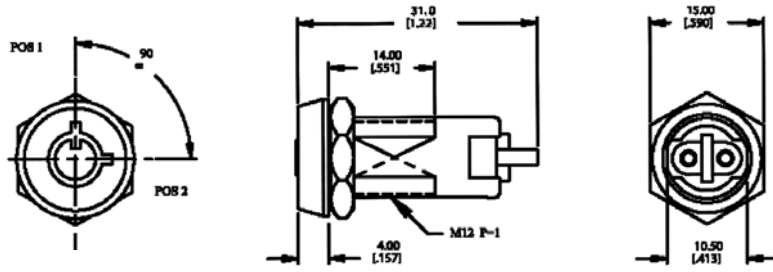

SHOWN: KO133A

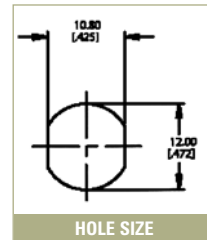

HOLE SIZE

FEATURES & BENEFITS

- ▶ Zinc alloy die cast housing and cylinder, chrome plated
- ▶ Zinc alloy keys, chrome plated with plastic cover
- ▶ Silver plated contacts and terminals
- ▶ 4 pins tumbler mechanism
- ▶ 200 combinations available

SPECIFICATIONS

Ratings:	1A @ 125 VAC
	0.5A @ 250 VAC
Contact Resistance:	20 mΩ max. initial @ 2-4 VDC, 100 mA
Insulation Resistance:	200 MΩ min.
Dielectric Strength:	1,500 V rms @ sea level

Part Number	Lock Configuration (as viewed from key end)	Connected Terminals				Key Pull Possible
		Pos. 1	Pos. 2	Pos. 3	Pos. 4	
KO133A	90° indexing	OFF	1-2			Pos. 1
KO133B	90° indexing	OFF	1-2			Pos. 1, Pos. 2
KO133C	90° indexing	OFF	1-2			Pos. 1

• = Detent Position ◯ = Keypull Possible ▼ = Momentary

TACT SWITCHES

NAVIGATION SWITCHES

PUSHBUTTON SWITCHES

TOGGLE SWITCHES

ROCKER SWITCHES

SLIDE SWITCHES

SNAP-ACTION SWITCHES

DIP SWITCHES

KEYLOCK SWITCHES

ROTARY SWITCHES

DETECTOR SWITCHES

CAP OPTIONS

SERIES KO SWITCHES

KEYLOCK COVERS



E-SWITCH®

KOM

1 DIE CAST ZINC

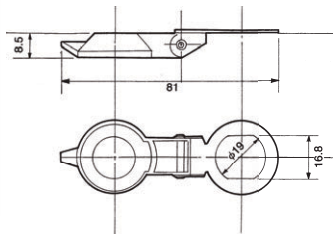

3 DIE CAST ZINC

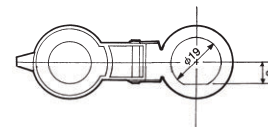

2 DIE CAST ZINC

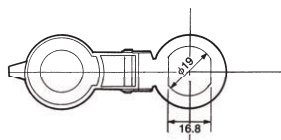

4 DIE CAST ZINC

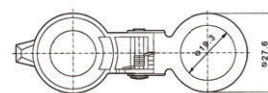

KOC

1 RUBBER

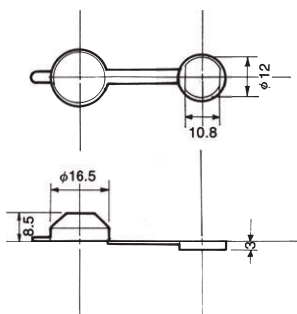

3 RUBBER

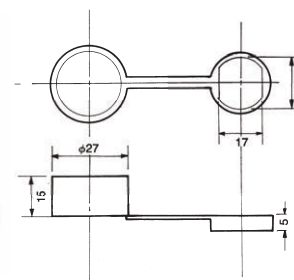

2 PLASTIC

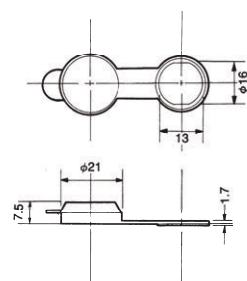

Model No.	Used for:
KOC1	KO 103, KO 131, KO 132
KOC2	KO 104
KOC3	KO 113, KO 114, KO 119, KO 120
KOM1-4	KO 113, KO 114

TACT SWITCHES

NAVIGATION SWITCHES

PUSHBUTTON SWITCHES

TOGGLE SWITCHES

ROCKER SWITCHES

SLIDE SWITCHES

SNAP-ACTION SWITCHES

DIP SWITCHES

KEYLOCK SWITCHES

ROTARY SWITCHES

DETECTOR SWITCHES

CAP OPTIONS

Mouser Electronics

Authorized Distributor

Click to View Pricing, Inventory, Delivery & Lifecycle Information:

E-Switch:

[KO129C](#) [KO121A](#) [KOM3](#) [KO114A10001](#) [KO104A10003](#) [KO104A10001](#) [KO118A125](#) [KO130OA126](#) [KOM4](#)
[KO106A-102](#) [KO103C701](#) [KO103A701](#) [KO126A1001](#) [KO128E2007](#) [KO129BA126](#) [KO103B701](#) [KO103D701](#)
[KO103E701](#) [KO104A10005](#) [KO104B10001](#) [KO104B10003](#) [KO104B10004](#) [KO104B10006](#) [KO104B10007](#)
[KO104B10008](#) [KO104B10009](#) [KO105A1001](#) [KO107A1097](#) [KO113B10001](#) [KO113C10001](#) [KO114C10001](#)
[KO115B10001](#) [KO119A7301](#) [KO119A7303](#) [KO119A7305](#) [KO119A7309](#) [KO119A7312](#) [KO119A7314](#) [KO119A7315](#)
[KO119A7316](#) [KO119A7317](#) [KO119A7320](#) [KO119A7321](#) [KO119A7322](#) [KO119A7323](#) [KO119A7324](#) [KO119A7326](#)
[KO124A10001](#) [KO124C10001](#) [KO128A2007](#) [KO128B2007](#) [KO128F2007](#) [KO128H2007](#) [KO129B606](#) [KO129CA126](#)
[KO129DA126](#) [KO129EA126](#) [KO129FA126](#) [KO129JA126](#) [KO129KA126](#) [KO129LA126](#) [KO129MA126](#)
[KO130AA126](#) [KO130CA126](#) [KO130E](#) [KO130HA126](#) [KO130J604](#) [KO130KA126](#) [KO130M](#) [KO130PA126](#)
[KO130Q601](#) [KO130Q602](#) [KO130Q603](#) [KO130Q605](#) [KO130Q607](#) [KO130QA123](#) [KO130QA126](#) [KO130QA132](#)
[KO130QA136](#) [KO130QA138](#) [KO130RA126](#) [KO130SA126](#) [KO130VA126](#) [KO130Z2](#) [KO130Z4A126](#) [KO132A1097](#)
[KO132A1501](#) [KO132B1501](#) [KO132C1501](#) [KO133A801](#) [KO133A816](#) [KO133B755](#) [KO133C755](#) [KO133C801](#)
[KO133E845](#) [KOC1](#) [KOC2](#) [KOKEY1001](#) [KOKEY102](#) [KOKEY701](#)