

# GenX3™ 600V IGBTs

High-Speed PT IGBTs for  
40-100kHz Switching

**IXGI48N60C3**  
**IXGA48N60C3**  
**IXGP48N60C3**  
**IXGH48N60C3**

**V<sub>CES</sub> = 600V**  
**I<sub>C110</sub> = 48A**  
**V<sub>CE(sat)</sub> ≤ 2.5V**  
**t<sub>fi(typ)</sub> = 38ns**

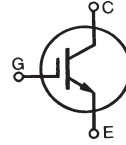

Symbol	Test Conditions	Maximum Ratings	
V <sub>CES</sub>	T <sub>C</sub> = 25°C to 150°C	600	V
V <sub>CGR</sub>	T <sub>J</sub> = 25°C to 150°C, R <sub>GE</sub> = 1MΩ	600	V
V <sub>GES</sub>	Continuous	± 20	V
V <sub>GEM</sub>	Transient	± 30	V
I <sub>C25</sub>	T <sub>C</sub> = 25°C	75	A
I <sub>C110</sub>	T <sub>C</sub> = 110°C	48	A
I <sub>CM</sub>	T <sub>C</sub> = 25°C, 1ms	250	A
I <sub>A</sub>	T <sub>C</sub> = 25°C	30	A
E <sub>AS</sub>	T <sub>C</sub> = 25°C	300	mJ
<b>SSOA</b> <b>(RBSOA)</b>	V <sub>GE</sub> = 15V, T <sub>VJ</sub> = 125°C, R <sub>G</sub> = 3Ω Clamped Inductive Load	I <sub>CM</sub> = 100 V <sub>CE</sub> ≤ V <sub>CES</sub>	A
P <sub>C</sub>	T <sub>C</sub> = 25°C	300	W
T <sub>J</sub>		-55 ... +150	°C
T <sub>JM</sub>		150	°C
T <sub>stg</sub>		-55 ... +150	°C
T <sub>L</sub>	1.6mm (0.062 in.) from Case for 10s	300	°C
T <sub>SOLD</sub>	Plastic Body for 10 Seconds	260	°C
F <sub>C</sub>	Mounting Force (TO-263 Lead)	10.65 / 2.5..14.6	N/lb.
M <sub>d</sub>	Mounting Torque (TO-247&TO-220)	1.13/10	Nm/lb.in.
<b>Weight</b>	TO-263	2.5	g
	TO-263 Lead	2.8	g
	TO-220	3.0	g
	TO-247	6.0	g

## Features

- Optimized for Low Switching Losses
- Square RBSOA
- Avalanche Rated
- Fast Switching
- International Standard Packages

## Advantages

- High Power Density
- Low Gate Drive Requirement

## Applications

- High Frequency Power Inverters
- UPS
- Motor Drives
- SMPS
- PFC Circuits
- Battery Chargers
- Welding Machines
- Lamp Ballasts

Symbol	Test Conditions (T <sub>J</sub> = 25°C Unless Otherwise Specified)	Characteristic Values		
		Min.	Typ.	Max.
BV <sub>CES</sub>	I <sub>C</sub> = 250μA, V <sub>GE</sub> = 0V	600		V
V <sub>GE(th)</sub>	I <sub>C</sub> = 250μA, V <sub>CE</sub> = V <sub>GE</sub>	3.0		5.5 V
I <sub>CES</sub>	V <sub>CE</sub> = V <sub>CES</sub> , V <sub>GE</sub> = 0V T <sub>J</sub> = 125°C			25 μA 250 μA
I <sub>GES</sub>	V <sub>CE</sub> = 0V, V <sub>GE</sub> = ± 20V			±100 nA
V <sub>CE(sat)</sub>	I <sub>C</sub> = 30A, V <sub>GE</sub> = 15V, Note 1 T <sub>J</sub> = 125°C		2.3 1.8	2.5 V V

Symbol	Test Conditions ( $T_J = 25^\circ\text{C}$ Unless Otherwise Specified)	Characteristic Values		
		Min.	Typ.	Max.
$g_{fs}$	$I_C = 30\text{A}, V_{CE} = 10\text{V}$ , Note 1	20	30	S
$C_{ies}$	$V_{CE} = 25\text{V}, V_{GE} = 0\text{V}, f = 1\text{MHz}$		1960	pF
$C_{oes}$			207	pF
$C_{res}$			66	pF
$Q_g$	$I_C = 30\text{A}, V_{GE} = 15\text{V}, V_{CE} = 0.5 \cdot V_{CES}$		77	nC
$Q_{ge}$			16	nC
$Q_{gc}$			32	nC
$t_{d(on)}$	<b>Inductive Load, <math>T_J = 25^\circ\text{C}</math></b> $I_C = 30\text{A}, V_{GE} = 15\text{V}$ $V_{CE} = 400\text{V}, R_G = 3\Omega$ Note 2		19	ns
$t_{ri}$			26	ns
$E_{on}$			0.41	mJ
$t_{d(off)}$			60	100 ns
$t_{fi}$			38	ns
$E_{off}$			0.23	0.42 mJ
$t_{d(on)}$	<b>Inductive Load, <math>T_J = 125^\circ\text{C}</math></b> $I_C = 30\text{A}, V_{GE} = 15\text{V}$ $V_{CE} = 400\text{V}, R_G = 3\Omega$ Note 2		19	ns
$t_{ri}$			26	ns
$E_{on}$			0.65	mJ
$t_{d(off)}$			92	ns
$t_{fi}$			95	ns
$E_{off}$			0.57	mJ
$R_{thJC}$			0.42	$^\circ\text{C/W}$
$R_{thCS}$	(TO-247)		0.21	$^\circ\text{C/W}$
	(TO-220)		0.50	$^\circ\text{C/W}$

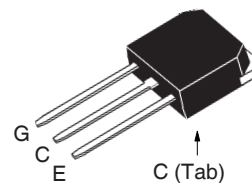
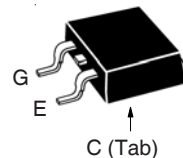
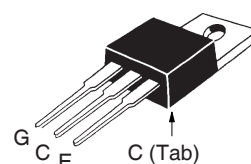
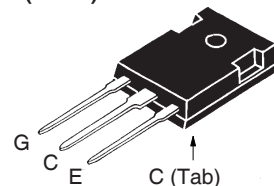
**TO-263 Lead (IXGI)**

**TO-263 AA (IXGA)**

**TO-220AB (IXGP)**

**TO-247 (IXGH)**

G = Gate      D = Collector  
S = Emitter    Tab = Collector

**Notes:**

1. Pulse test,  $t \leq 300\mu\text{s}$ , duty cycle,  $d \leq 2\%$ .
2. Switching times & energy losses may increase for higher  $V_{CE}(\text{Clamp})$ ,  $T_J$  or  $R_G$ .

**IXYS Reserves the Right to Change Limits, Test Conditions and Dimensions.**

IXYS MOSFETs and IGBTs are covered by one or more of the following U.S. patents:

4,835,592	4,931,844	5,049,961	5,237,481	6,162,665	6,404,065 B1	6,683,344	6,727,585	7,005,734 B2	7,157,338B2
4,850,072	5,017,508	5,063,307	5,381,025	6,259,123 B1	6,534,343	6,710,405 B2	6,759,692	7,063,975 B2	
4,881,106	5,034,796	5,187,117	5,486,715	6,306,728 B1	6,583,505	6,710,463	6,771,478 B2	7,071,537	

### Leaded 263 Outline

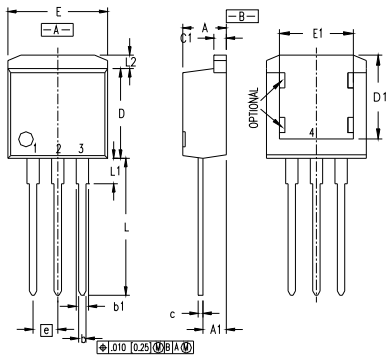

Pins: 1 - Gate 2,4 - Collector  
3 - Emitter

SYM	INCHES		MILLIMETERS	
	MIN	MAX	MIN	MAX
A	.160	.190	4.06	4.83
A1	.080	.110	2.03	2.79
b	.025	.039	0.51	0.99
b2	.025	.039	1.14	1.40
c	.018	.029	0.46	0.74
c2	.018	.029	1.14	1.40
D	.340	.380	8.64	9.65
D1	.315	.350	8.00	8.89
E	.380	.405	9.65	10.29
E1	.245	.320	6.22	8.13
e	.100 BSC		2.54 BSC	
L	.500	.580	14.61	15.88
L1	.080	.130	2.29	2.79
L2	.040	.055	1.02	1.40

### TO-247 Outline

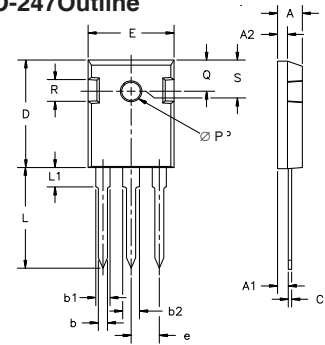

Pins: 1 - Gate 2 - Collector  
3 - Emitter

Dim.	Millimeter		Inches	
	Min.	Max.	Min.	Max.
A	4.7	5.3	.185	.209
A <sub>1</sub>	2.2	2.54	.087	.102
A <sub>2</sub>	2.2	2.6	.059	.098
b	1.0	1.4	.040	.055
b <sub>1</sub>	1.65	2.13	.065	.084
b <sub>2</sub>	2.87	3.12	.113	.123
C	.4	.8	.016	.031
D	20.80	21.46	.819	.845
E	15.75	16.26	.610	.640
e	5.20	5.72	0.205	0.225
L	19.81	20.32	.780	.800
L1		4.50		.177
∅P	3.55	3.65	.140	.144
Q	5.89	6.40	0.232	0.252
R	4.32	5.49	.170	.216
S	6.15	BSC	242	BSC

### TO-263 Outline

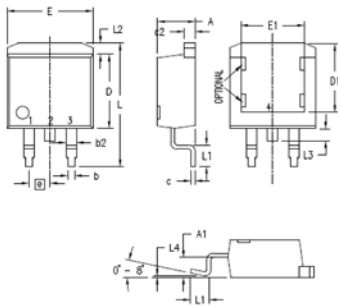

Pins: 1 - Gate 2,4 - Collector  
3 - Emitter

SYM	INCHES		MILLIMETERS	
	MIN	MAX	MIN	MAX
A	.160	.190	4.06	4.83
A1	.080	.110	2.03	2.79
b	.020	.039	0.51	0.99
b2	.045	.055	1.14	1.40
c	.016	.029	0.40	0.74
c2	.045	.055	1.14	1.40
D	.340	.380	8.64	9.65
D1	.315	.350	8.00	8.89
E	.380	.410	9.65	10.41
E1	.245	.320	6.22	8.13
e	.100 BSC		2.54 BSC	
L	.575	.625	14.61	15.88
L1	.090	.110	2.29	2.79
L2	.040	.055	1.02	1.40
L3	.050	.070	1.27	1.78
L4	0	.005	0	0.13

### TO-220 Outline

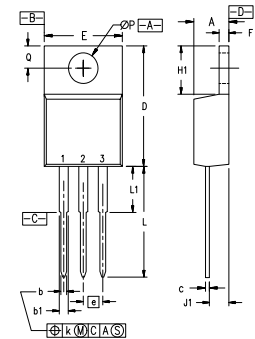

Pins: 1 - Gate 2 - Collector  
3 - Emitter

SYM	INCHES		MILLIMETERS	
	MIN	MAX	MIN	MAX
A	.170	.190	4.32	4.83
b	.025	.040	0.64	1.02
b1	.045	.065	1.15	1.65
c	.014	.022	0.35	0.56
D	.580	.630	14.73	16.00
E	.390	.420	9.91	10.66
e	.100 BSC		2.54 BSC	
F	.045	.055	1.14	1.40
H1	.230	.270	5.85	6.85
J1	.090	.110	2.29	2.79
k	0	.015	0	0.38
L	.500	.550	12.70	13.97
L1	.110	.230	2.79	5.84
∅P	.139	.161	3.53	4.08
Q	.100	.125	2.54	3.18

**Fig. 1. Output Characteristics @  $T_J = 25^\circ\text{C}$**

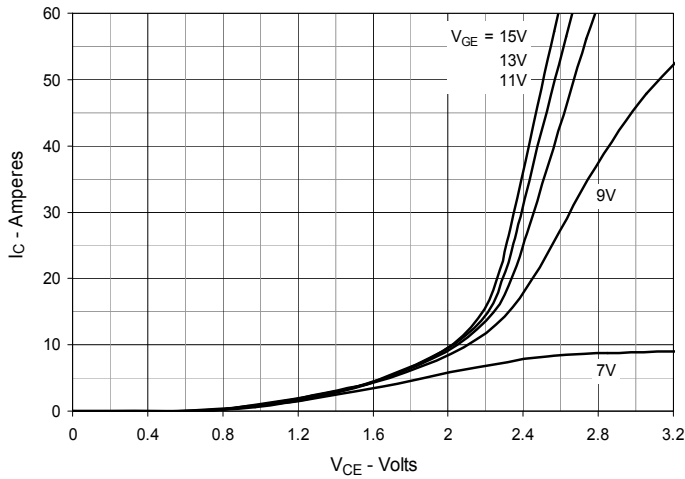

**Fig. 2. Extended Output Characteristics @  $T_J = 25^\circ\text{C}$**

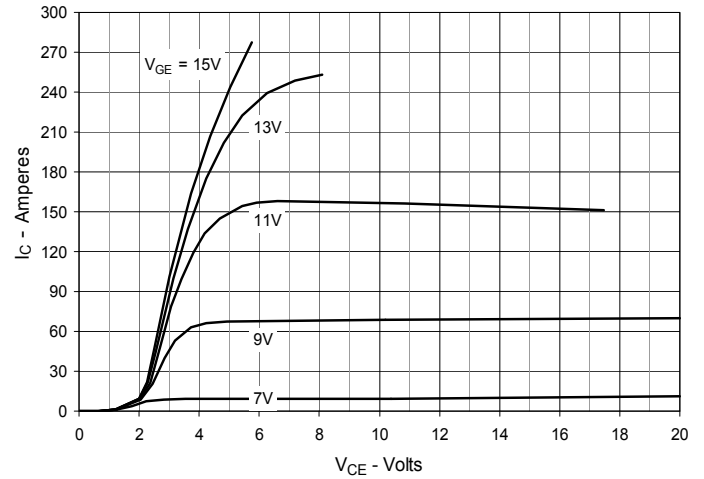

**Fig. 3. Output Characteristics @  $T_J = 125^\circ\text{C}$**

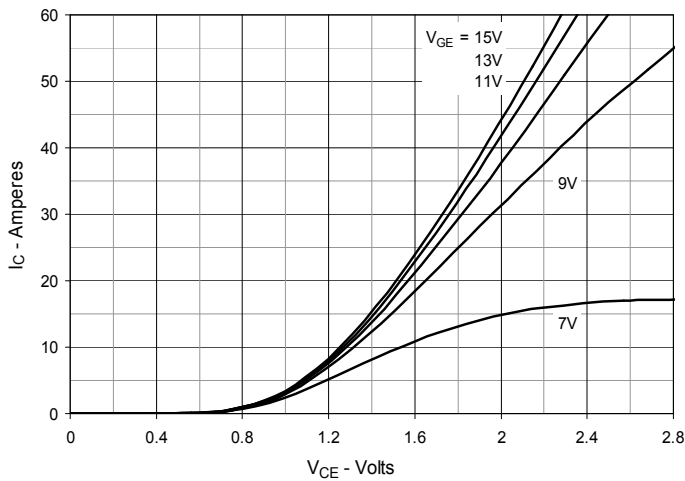

**Fig. 4. Dependence of  $V_{CE(sat)}$  on Junction Temperature**

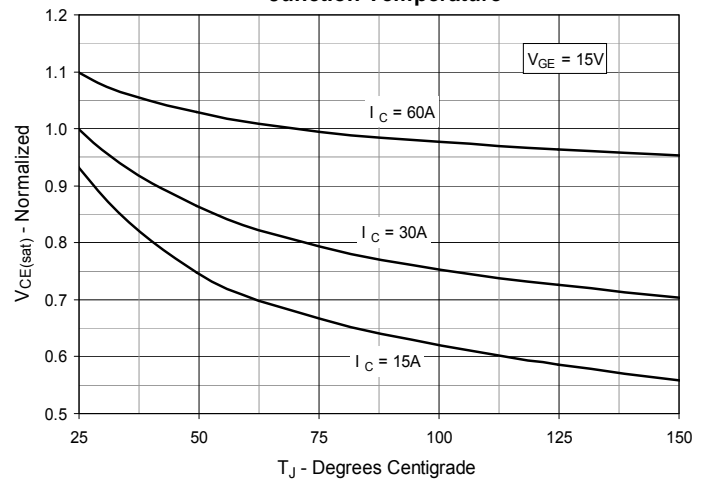

**Fig. 5. Collector-to-Emitter Voltage vs. Gate-to-Emitter Voltage**

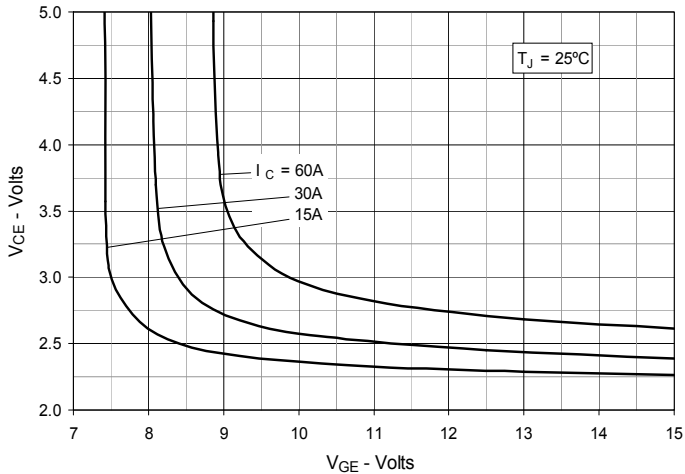

**Fig. 6. Input Admittance**

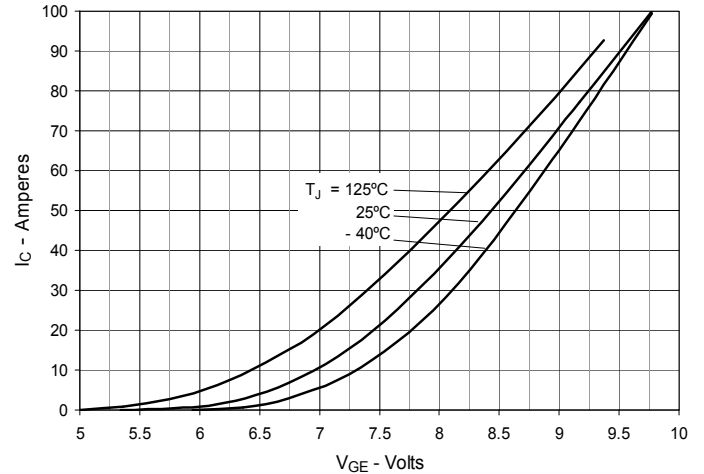

Fig. 7. Transconductance

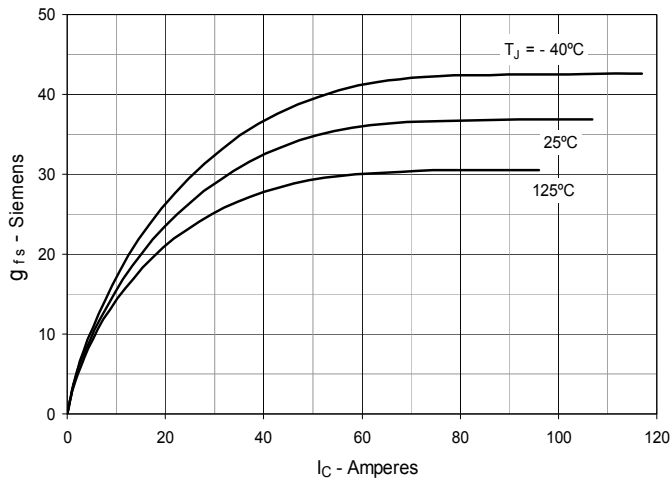

Fig. 8. Gate Charge

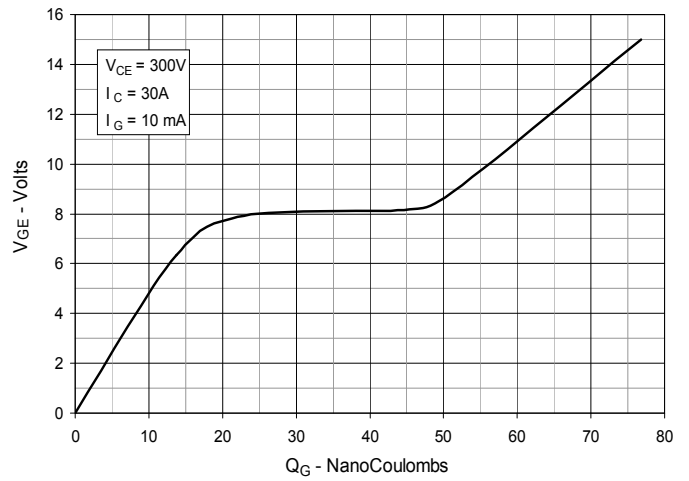

Fig. 9. Capacitance

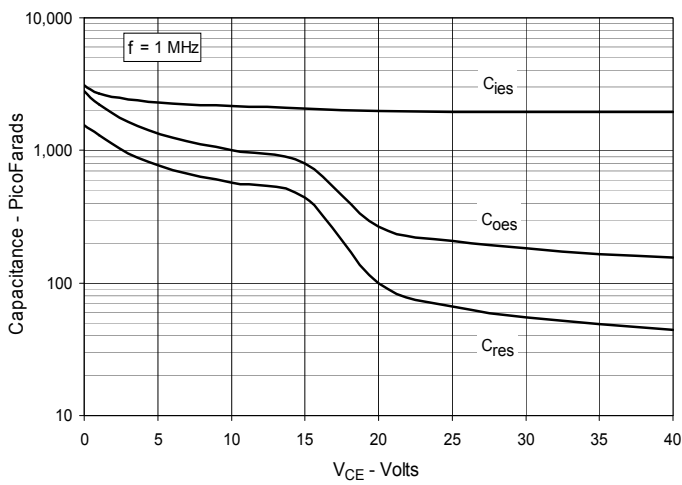

Fig. 10. Reverse-Bias Safe Operating Area

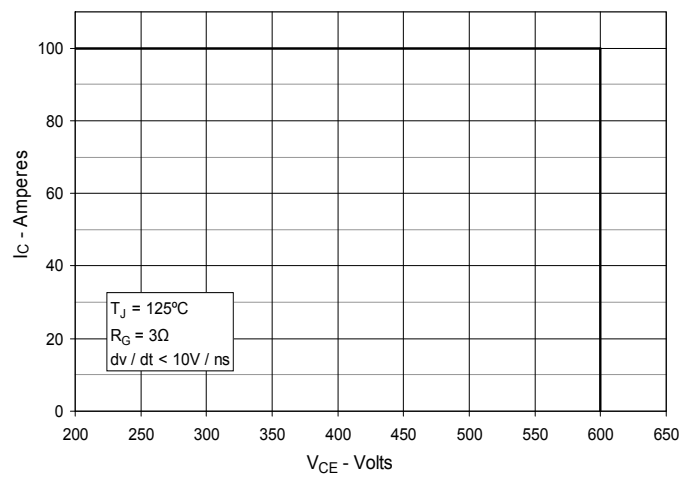
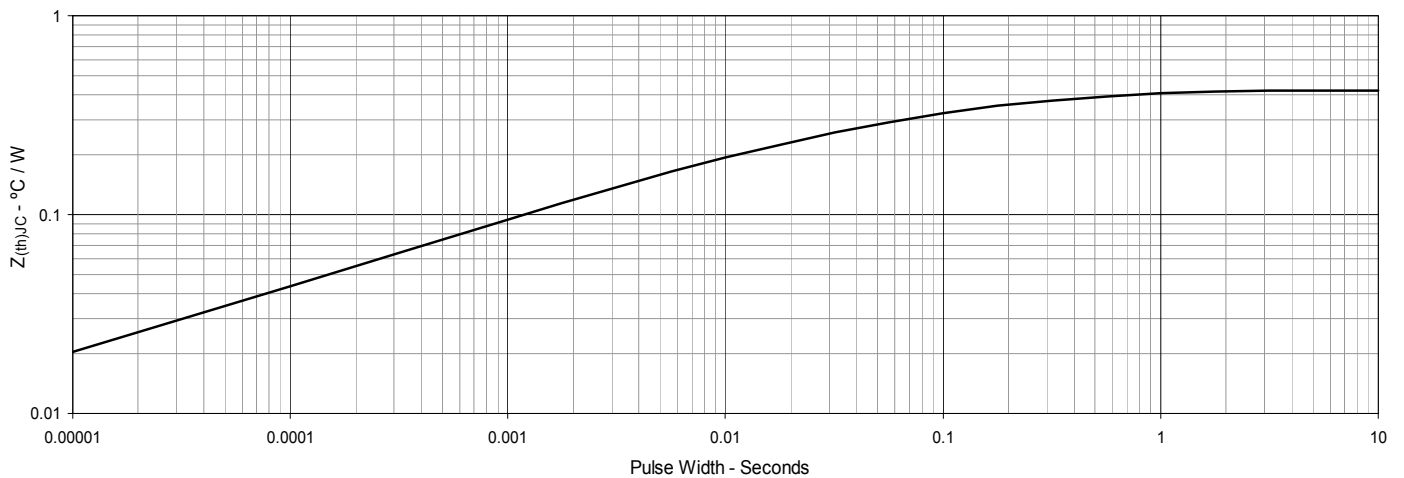
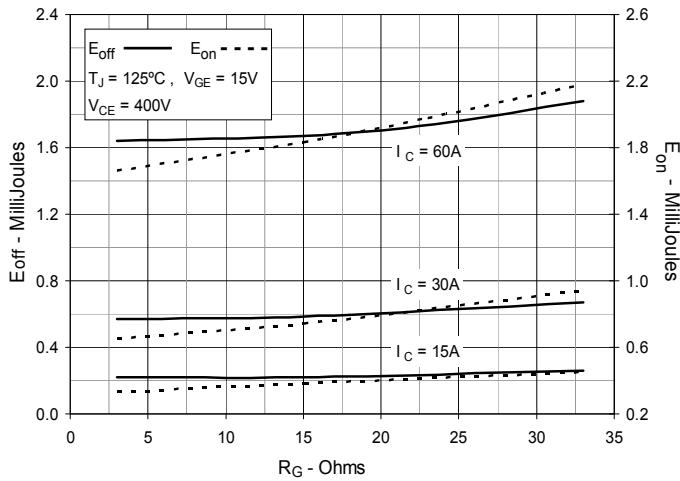

Fig. 11. Maximum Transient Thermal Impedance



**Fig. 12. Inductive Switching Energy Loss vs. Gate Resistance**



**Fig. 13. Inductive Switching Energy Loss vs. Collector Current**

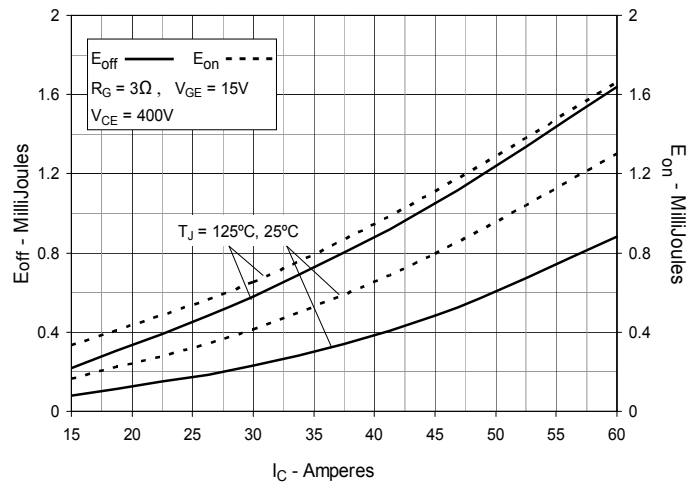

**Fig. 14. Inductive Switching Energy Loss vs. Junction Temperature**

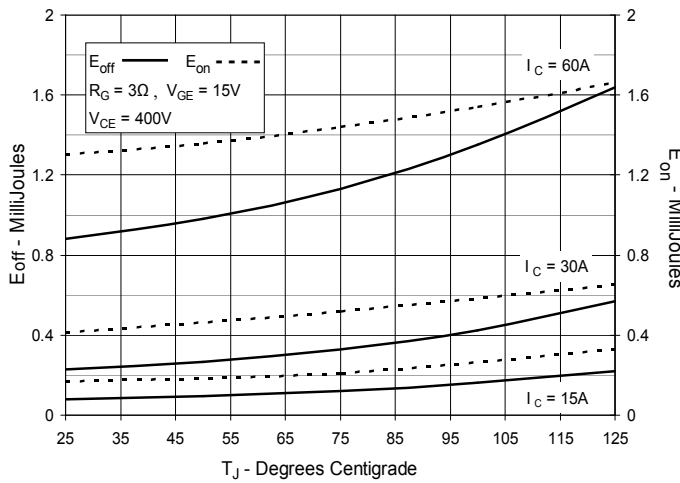

**Fig. 15. Inductive Turn-off Switching Times vs. Gate Resistance**

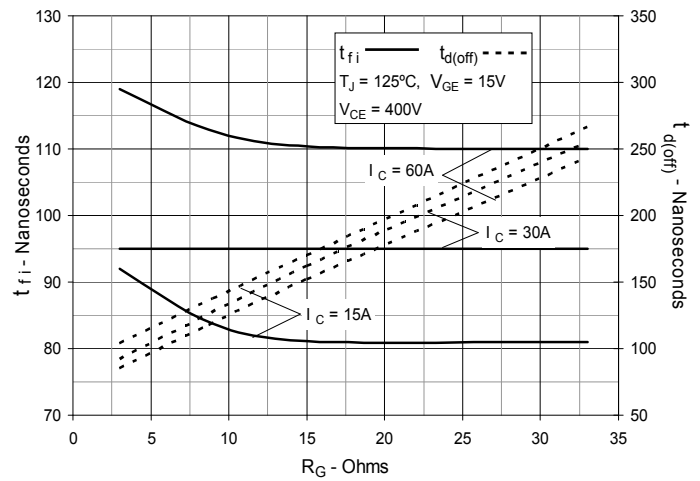

**Fig. 16. Inductive Turn-off Switching Times vs. Collector Current**

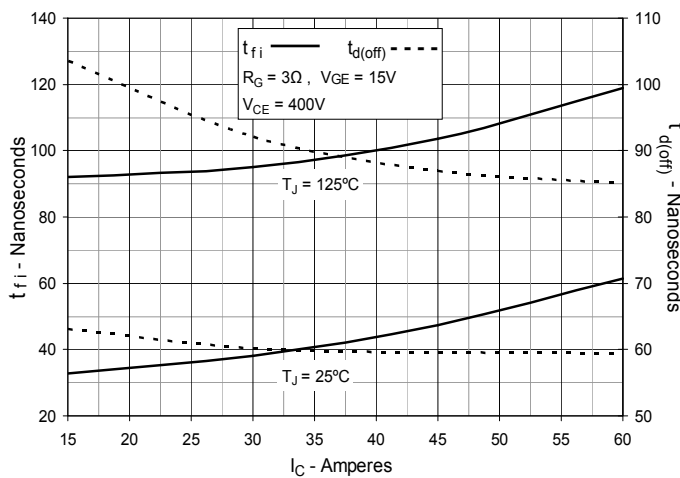

**Fig. 17. Inductive Turn-off Switching Times vs. Junction Temperature**

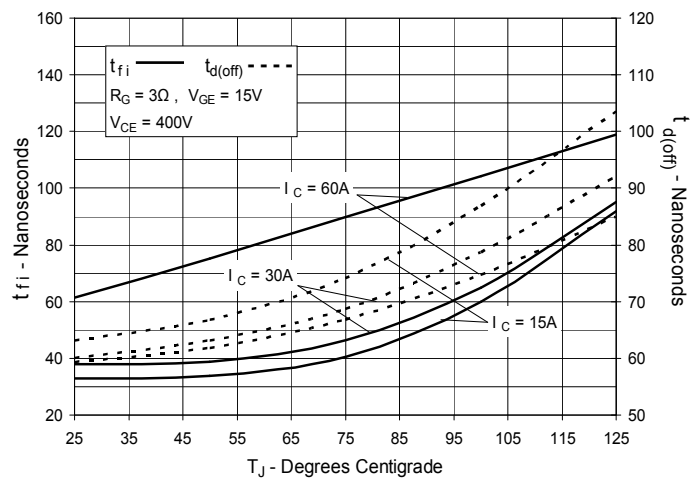

**Fig. 18. Inductive Turn-on Switching Times vs. Gate Resistance**

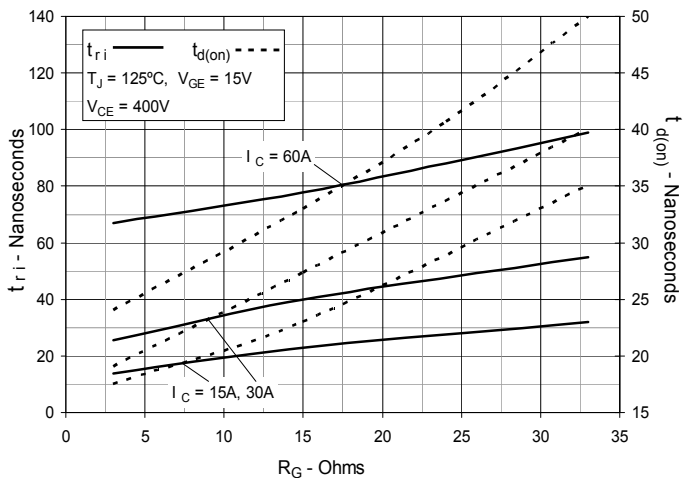

**Fig. 19. Inductive Turn-on Switching Times vs. Collector Current**

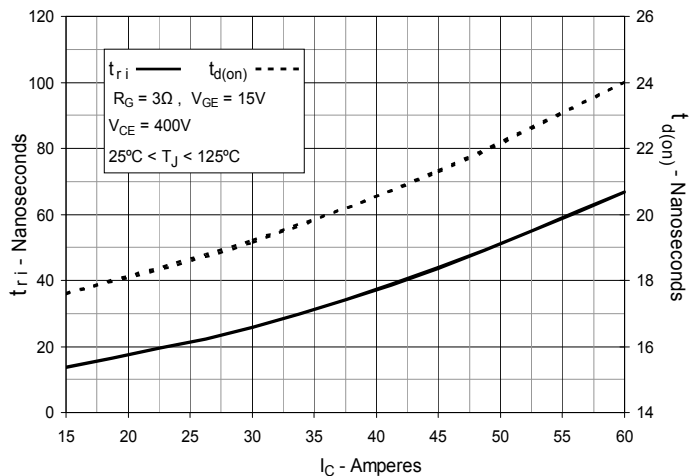

**Fig. 20. Inductive Turn-on Switching Times vs. Junction Temperature**

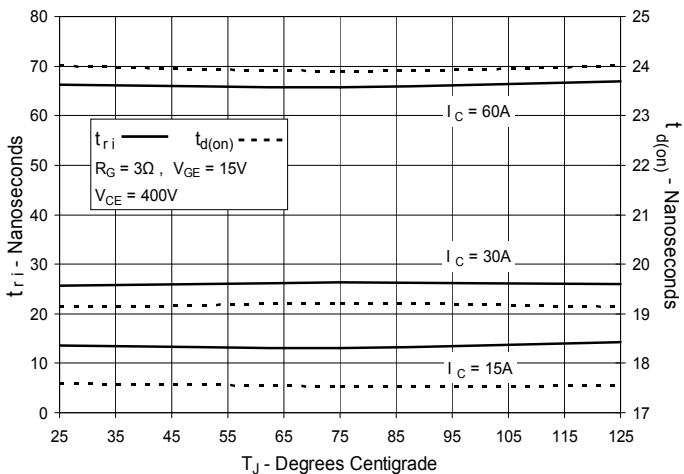

# Mouser Electronics

Authorized Distributor

Click to View Pricing, Inventory, Delivery & Lifecycle Information:

[IXYS:](#)

[IXGP48N60C3](#) [IXGA48N60C3](#) [IXGH48N60C3](#)