

**Features**

- Low VCE (on) Non Punch Through IGBT Technology.
- 10µs Short Circuit Capability.
- Square RBSOA.
- Positive VCE (on) Temperature Coefficient.
- Maximum Junction Temperature rated at 175°C.

**Benefits**

- Benchmark Efficiency for Motor Control.
- Rugged Transient Performance.
- Low EMI.
- Excellent Current Sharing in Parallel Operation.

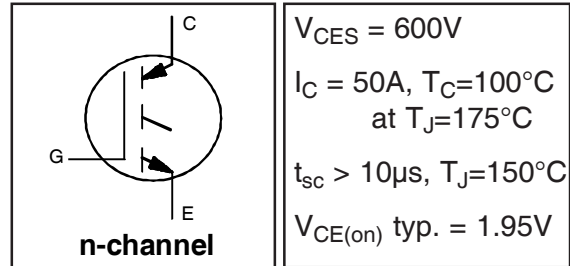

$V_{CES} = 600V$   
 $I_C = 50A, T_C=100^\circ C$   
 at  $T_J=175^\circ C$   
 $t_{sc} > 10\mu s, T_J=150^\circ C$   
 $V_{CE(on)} \text{ typ.} = 1.95V$

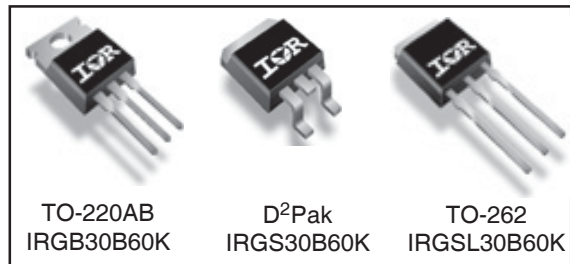

TO-220AB  
IRGB30B60K

D²Pak  
IRGS30B60K

TO-262  
IRGSL30B60K

**Absolute Maximum Ratings**

	Parameter	Max.	Units
$V_{CES}$	Collector-to-Emitter Voltage	600	V
$I_C @ T_C = 25^\circ C$	Continuous Collector Current	78 <sup>⑤</sup>	A
$I_C @ T_C = 100^\circ C$	Continuous Collector Current	50	
$I_{CM}$	Pulse Collector Current (Ref.Fig.C.T.5)	120	
$I_{LM}$	Clamped Inductive Load current ①	120	
$V_{ISOL}$	RMS Isolation Voltage, Terminal to Case, t=1 min.	2500	V
$V_{GE}$	Gate-to-Emitter Voltage	±20	
$P_D @ T_C = 25^\circ C$	Maximum Power Dissipation	370	W
$P_D @ T_C = 100^\circ C$	Maximum Power Dissipation	180	
$T_J$	Operating Junction and	-55 to +175	°C
$T_{STG}$	Storage Temperature Range		
	Soldering Temperature, for 10 sec.	300 (0.063 in. (1.6mm) from case)	
	Mounting Torque, 6-32 or M3 Screw	10 lbf-in (1.1 N·m)	

**Thermal / Mechanical Characteristics**

	Parameter	Min.	Typ.	Max.	Units
$R_{\theta JC}$	Junction-to-Case- IGBT	—	—	0.41	°C/W
$R_{\theta CS}$	Case-to-Sink, flat, greased surface	—	0.50	—	
$R_{\theta JA}$	Junction-to-Ambient, typical socket mount ②	—	—	62	
$R_{\theta JA}$	Junction-to-Ambient (PCB Mount, Steady State) ③	—	—	40	
Wt	Weight	—	1.44	—	g

## Electrical Characteristics @ T<sub>J</sub> = 25°C (unless otherwise specified)

	Parameter	Min.	Typ.	Max.	Units	Conditions	Ref.Fig.
V <sub>(BR)CES</sub>	Collector-to-Emitter Breakdown Voltage	600	—	—	V	V <sub>GE</sub> = 0V, I <sub>C</sub> = 500μA	
ΔV <sub>(BR)CES/ΔT<sub>J</sub></sub>	Temperature Coeff. of Breakdown Voltage	—	0.40	—	V/°C	V <sub>GE</sub> = 0V, I <sub>C</sub> = 1mA (25°C-150°C)	
V <sub>CE(on)</sub>	Collector-to-Emitter Voltage	—	1.95	2.35	V	I <sub>C</sub> = 30A, V <sub>GE</sub> = 15V, T <sub>J</sub> = 25°C	5,6,7
		—	2.40	2.75		I <sub>C</sub> = 30A, V <sub>GE</sub> = 15V, T <sub>J</sub> = 150°C	8,9,10
		—	2.6	2.95		I <sub>C</sub> = 30A, V <sub>GE</sub> = 15V, T <sub>J</sub> = 175°C	
V <sub>GE(th)</sub>	Gate Threshold Voltage	3.5	4.5	5.5	V	V <sub>CE</sub> = V <sub>GE</sub> , I <sub>C</sub> = 250μA	8,9,10
ΔV <sub>GE(th)/ΔT<sub>J</sub></sub>	Threshold Voltage temp. coefficient	—	-10	—	mV/°C	V <sub>CE</sub> = V <sub>GE</sub> , I <sub>C</sub> = 1.0mA (25°C-150°C)	11
g <sub>fe</sub>	Forward Transconductance	—	18	—	S	V <sub>CE</sub> = 50V, I <sub>C</sub> = 50A, PW = 80μs	
I <sub>CES</sub>	Zero Gate Voltage Collector Current	—	5.0	250	μA	V <sub>GE</sub> = 0V, V <sub>CE</sub> = 600V	
		—	1000	2000		V <sub>GE</sub> = 0V, V <sub>CE</sub> = 600V, T <sub>J</sub> = 150°C	
		—	1830	3000		V <sub>GE</sub> = 0V, V <sub>CE</sub> = 600V, T <sub>J</sub> = 175°C	
I <sub>GES</sub>	Gate-to-Emitter Leakage Current	—	—	±100	nA	V <sub>GE</sub> = ±20V, V <sub>CE</sub> = 0V	

## Switching Characteristics @ T<sub>J</sub> = 25°C (unless otherwise specified)

	Parameter	Min.	Typ.	Max.	Units	Conditions	Ref.Fig.
Q <sub>g</sub>	Total Gate Charge (turn-on)	—	102	153	nC	I <sub>C</sub> = 30A	17
Q <sub>ge</sub>	Gate-to-Emitter Charge (turn-on)	—	14	21		V <sub>CC</sub> = 400V	CT1
Q <sub>gc</sub>	Gate-to-Collector Charge (turn-on)	—	44	66		V <sub>GE</sub> = 15V	
E <sub>on</sub>	Turn-On Switching Loss	—	350	620	μJ	I <sub>C</sub> = 30A, V <sub>CC</sub> = 400V	CT4
E <sub>off</sub>	Turn-Off Switching Loss	—	825	955		V <sub>GE</sub> = 15V, R <sub>G</sub> = 10Ω, L = 200μH	
E <sub>tot</sub>	Total Switching Loss	—	1175	1575		T <sub>J</sub> = 25°C ④	
t <sub>d(on)</sub>	Turn-On delay time	—	46	60	ns	I <sub>C</sub> = 30A, V <sub>CC</sub> = 400V	CT4
t <sub>r</sub>	Rise time	—	28	39		V <sub>GE</sub> = 15V, R <sub>G</sub> = 10Ω, L = 200μH	
t <sub>d(off)</sub>	Turn-Off delay time	—	185	200		T <sub>J</sub> = 25°C	
t <sub>f</sub>	Fall time	—	31	40			
E <sub>on</sub>	Turn-On Switching Loss	—	635	1085	μJ	I <sub>C</sub> = 30A, V <sub>CC</sub> = 400V	CT4
E <sub>off</sub>	Turn-Off Switching Loss	—	1150	1350		V <sub>GE</sub> = 15V, R <sub>G</sub> = 10Ω, L = 200μH	12,14
E <sub>tot</sub>	Total Switching Loss	—	1785	2435		T <sub>J</sub> = 150°C ④	WF1,WF2
t <sub>d(on)</sub>	Turn-On delay time	—	46	60	ns	I <sub>C</sub> = 30A, V <sub>CC</sub> = 400V	13,15
t <sub>r</sub>	Rise time	—	28	39		V <sub>GE</sub> = 15V, R <sub>G</sub> = 10Ω, L = 200μH	CT4
t <sub>d(off)</sub>	Turn-Off delay time	—	205	235		T <sub>J</sub> = 150°C	WF1
t <sub>f</sub>	Fall time	—	32	42			WF2
L <sub>E</sub>	Internal Emitter Inductance	—	7.5	—	nH	Measured 5mm from package	
C <sub>ies</sub>	Input Capacitance	—	1750	2500	pF	V <sub>GE</sub> = 0V	16
C <sub>oes</sub>	Output Capacitance	—	160	255		V <sub>CC</sub> = 30V	
C <sub>res</sub>	Reverse Transfer Capacitance	—	60	90		f = 1.0MHz	
RBSOA	Reverse Bias Safe Operating Area	FULL SQUARE				T <sub>J</sub> = 150°C, I <sub>C</sub> = 120A, V <sub>p</sub> = 600V V <sub>CC</sub> =500V, V <sub>GE</sub> = +15V to 0V, R <sub>G</sub> = 10Ω	4 CT2
SCSOA	Short Circuit Safe Operating Area	10	—	—	μs	T <sub>J</sub> = 150°C, V <sub>p</sub> = 600V, R <sub>G</sub> = 10Ω V <sub>CC</sub> =360V, V <sub>GE</sub> = +15V to 0V	CT3 WF3
I <sub>SC (Peak)</sub>	Peak Short Circuit Collector Current	—	200	—	A		WF3

Note ① to ⑤ are on page 13

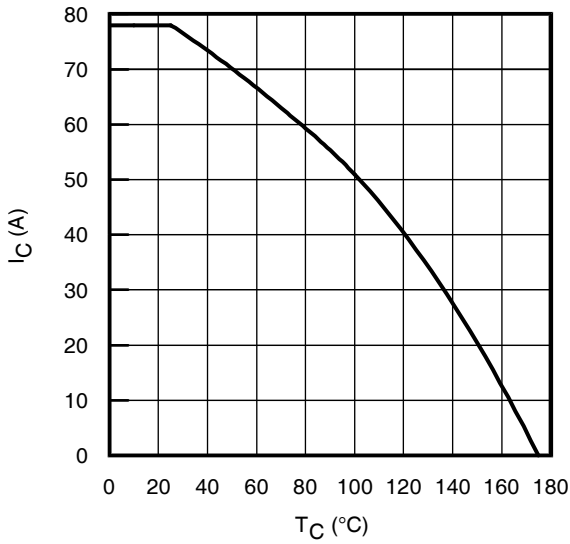

**Fig. 1** - Maximum DC Collector Current vs. Case Temperature

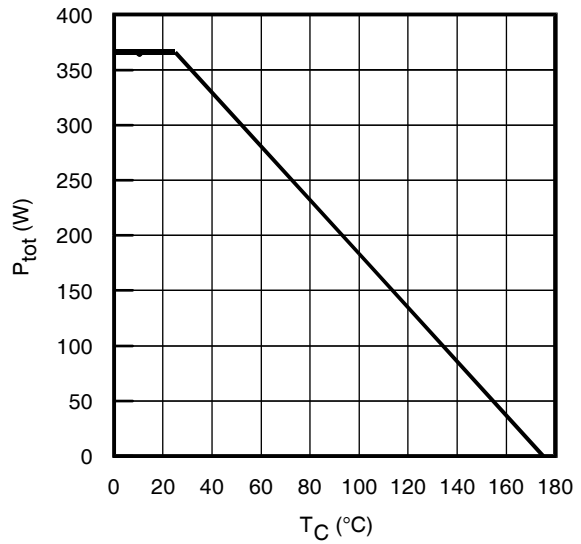

**Fig. 2** - Power Dissipation vs. Case Temperature

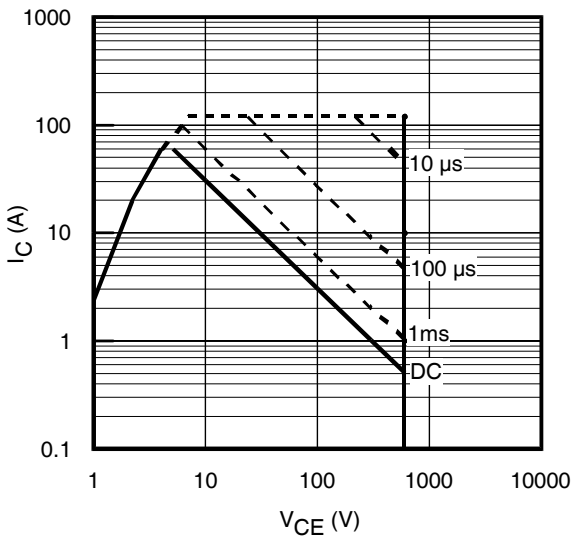

**Fig. 3** - Forward SOA  
 $T_C = 25^{\circ}C$ ;  $T_J \leq 150^{\circ}C$

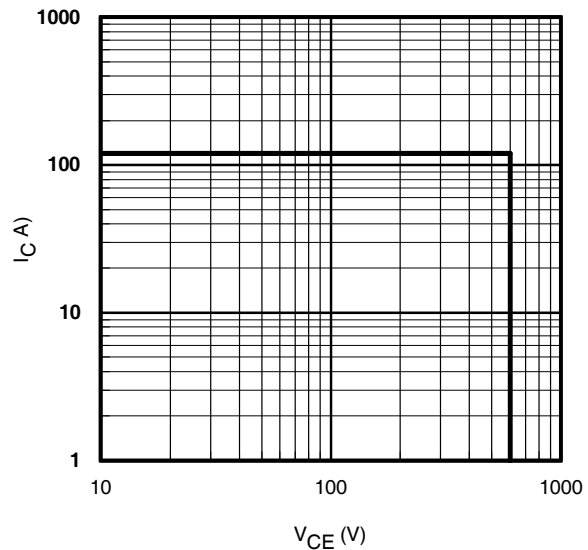

**Fig. 4** - Reverse Bias SOA  
 $T_J = 150^{\circ}C$ ;  $V_{GE} = 15V$

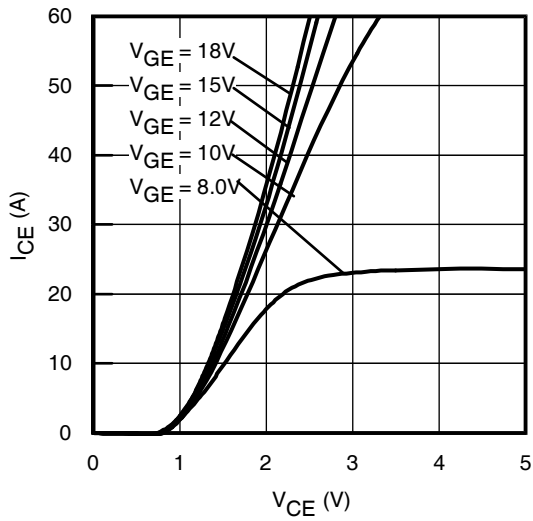

**Fig. 5** - Typ. IGBT Output Characteristics  
 $T_J = -40^\circ\text{C}$ ;  $t_p = 80\mu\text{s}$

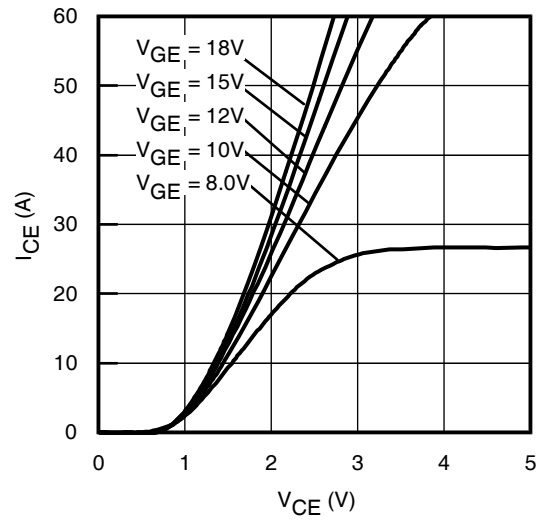

**Fig. 6** - Typ. IGBT Output Characteristics  
 $T_J = 25^\circ\text{C}$ ;  $t_p = 80\mu\text{s}$

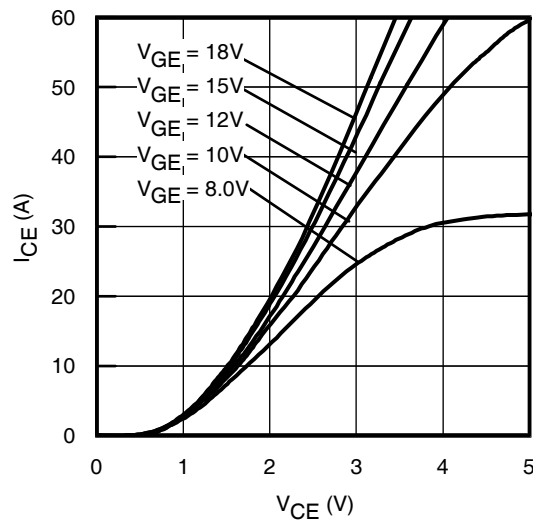

**Fig. 7** - Typ. IGBT Output Characteristics  
 $T_J = 150^\circ\text{C}$ ;  $t_p = 80\mu\text{s}$

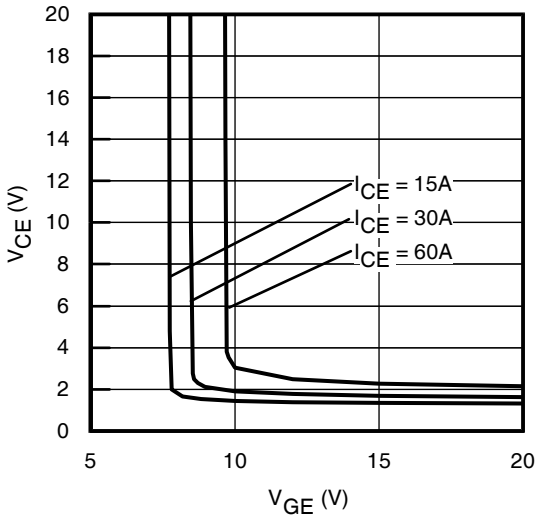

**Fig. 8** - Typical  $V_{CE}$  vs.  $V_{GE}$   
 $T_J = -40^\circ\text{C}$

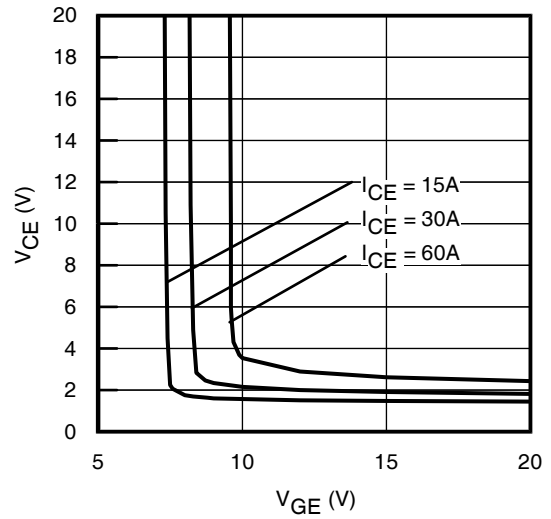

**Fig. 9** - Typical  $V_{CE}$  vs.  $V_{GE}$   
 $T_J = 25^\circ\text{C}$

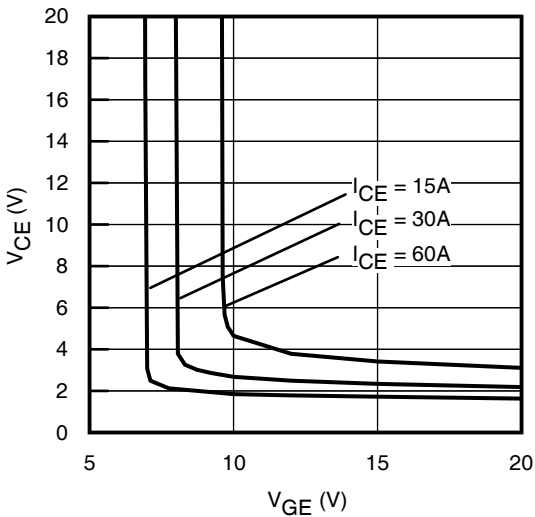

**Fig. 10** - Typical  $V_{CE}$  vs.  $V_{GE}$   
 $T_J = 150^\circ\text{C}$

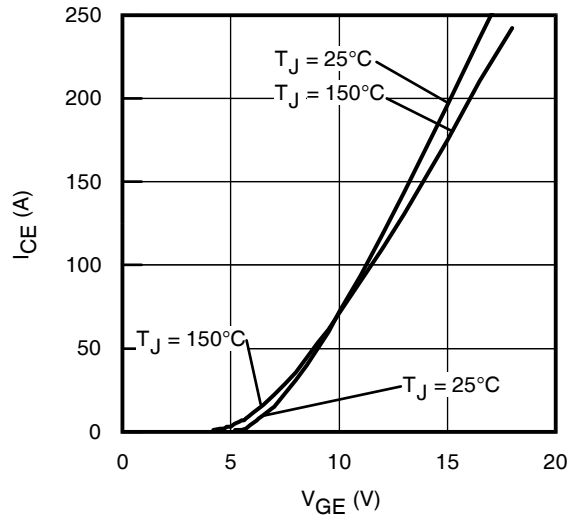

**Fig. 11** - Typ. Transfer Characteristics  
 $V_{CE} = 50\text{V}$ ;  $t_p = 10\mu\text{s}$

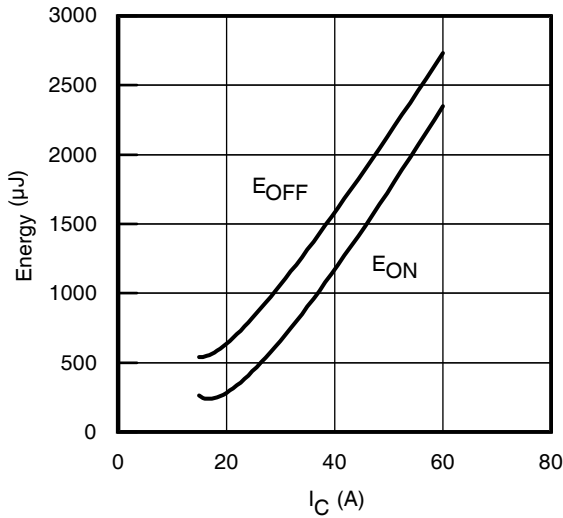

**Fig. 12** - Typ. Energy Loss vs.  $I_C$   
 $T_J = 150^\circ\text{C}$ ;  $L=200\mu\text{H}$ ;  $V_{CE}= 400\text{V}$ ,  
 $R_G= 10\Omega$ ;  $V_{GE}= 15\text{V}$

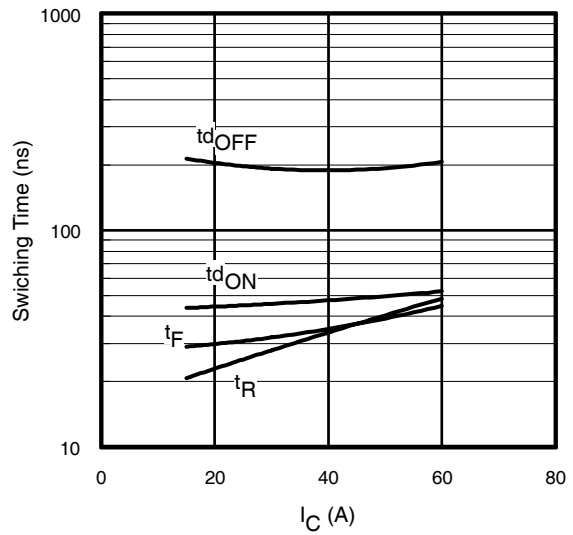

**Fig. 13** - Typ. Switching Time vs.  $I_C$   
 $T_J = 150^\circ\text{C}$ ;  $L=200\mu\text{H}$ ;  $V_{CE}= 400\text{V}$   
 $R_G= 10\Omega$ ;  $V_{GE}= 15\text{V}$

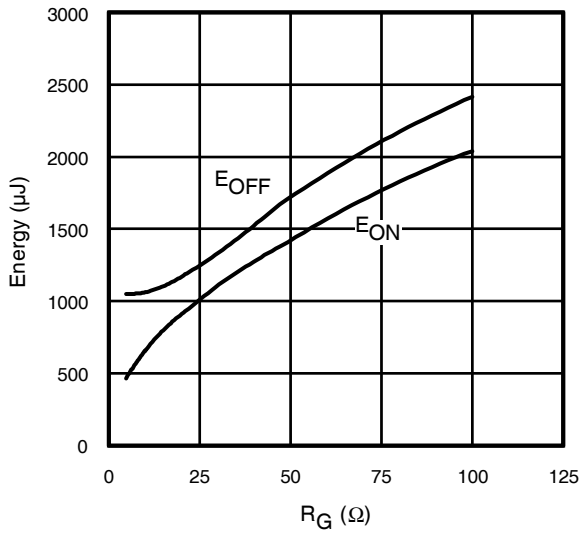

**Fig. 14** - Typ. Energy Loss vs.  $R_G$   
 $T_J = 150^\circ\text{C}$ ;  $L=200\mu\text{H}$ ;  $V_{CE}= 400\text{V}$   
 $I_{CE}= 30\text{A}$ ;  $V_{GE}= 15\text{V}$

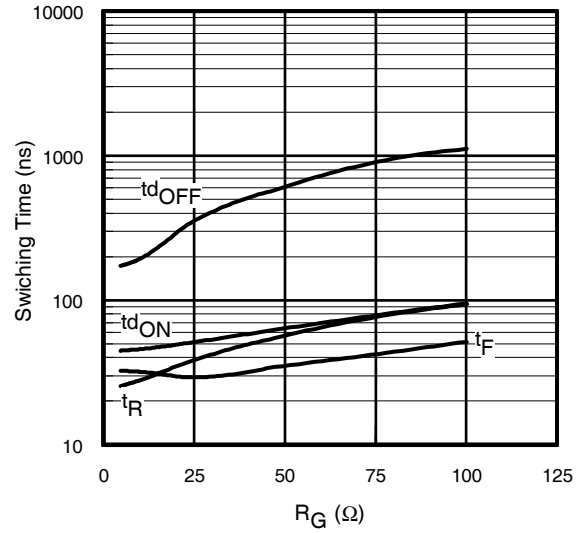

**Fig. 15** - Typ. Switching Time vs.  $R_G$   
 $T_J = 150^\circ\text{C}$ ;  $L=200\mu\text{H}$ ;  $V_{CE}= 400\text{V}$   
 $I_{CE}= 30\text{A}$ ;  $V_{GE}= 15\text{V}$

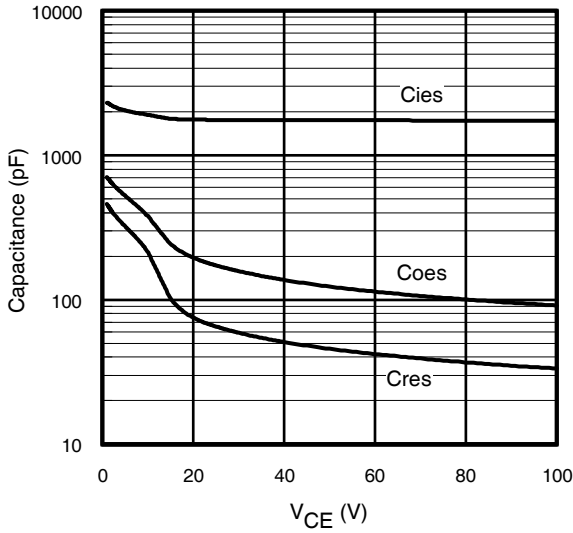

**Fig. 16-** Typ. Capacitance vs. V<sub>CE</sub>  
V<sub>GE</sub> = 0V; f = 1MHz

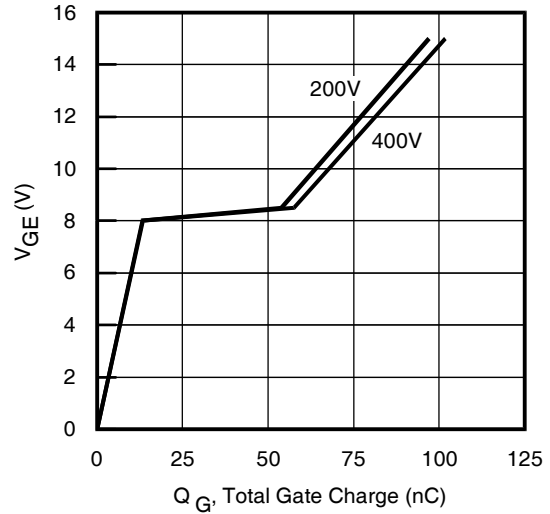

**Fig. 17 -** Typical Gate Charge vs. V<sub>GE</sub>  
I<sub>CE</sub> = 30A; L = 600μH

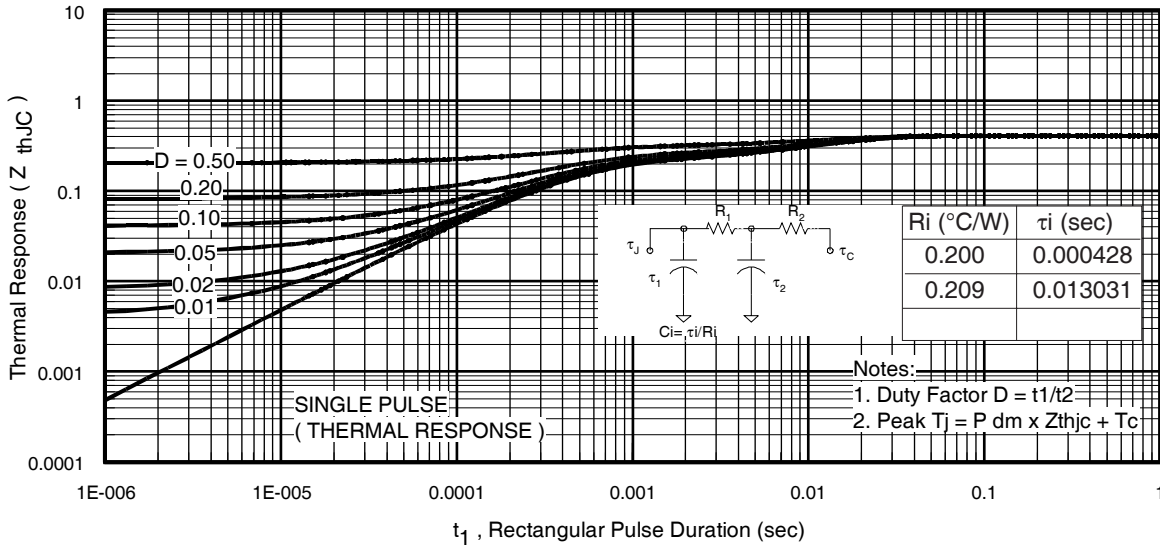

**Fig 18.** Maximum Transient Thermal Impedance, Junction-to-Case (IGBT)

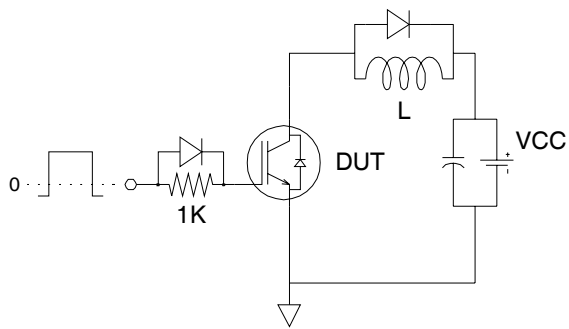

**Fig.C.T.1** - Gate Charge Circuit (turn-off)

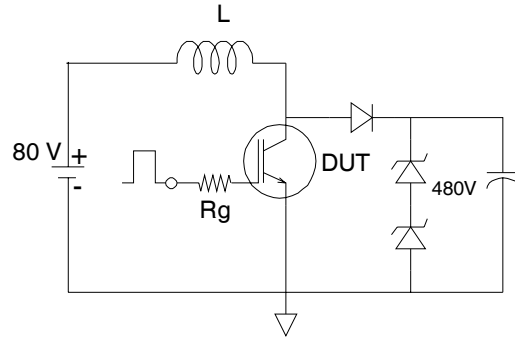

**Fig.C.T.2** - RBSOA Circuit

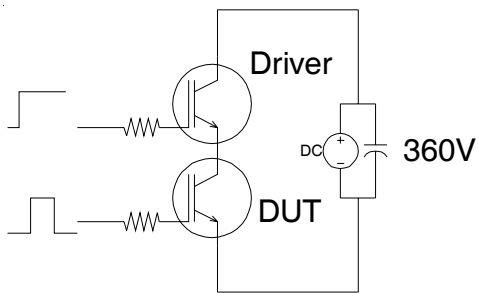

**Fig.C.T.3** - S.C.SOA Circuit

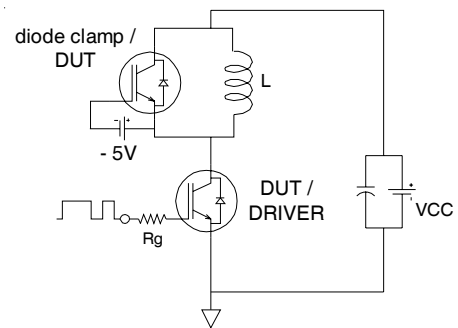

**Fig.C.T.4** - Switching Loss Circuit

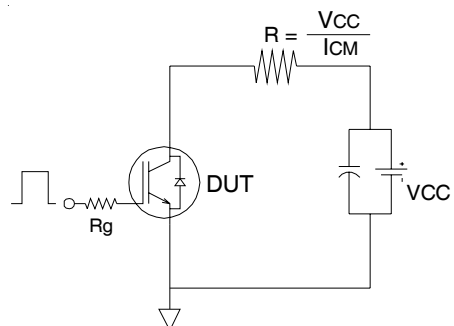

**Fig.C.T.5** - Resistive Load Circuit



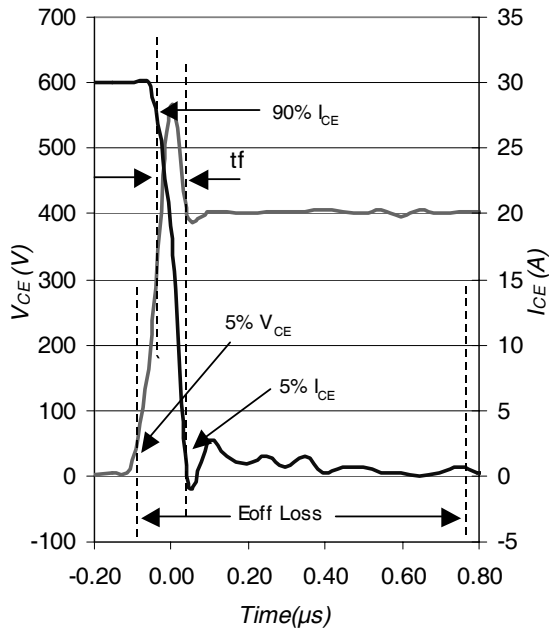

Fig. WF1- Typ. Turn-off Loss Waveform  
@  $T_J = 150^\circ\text{C}$  using Fig. CT.4

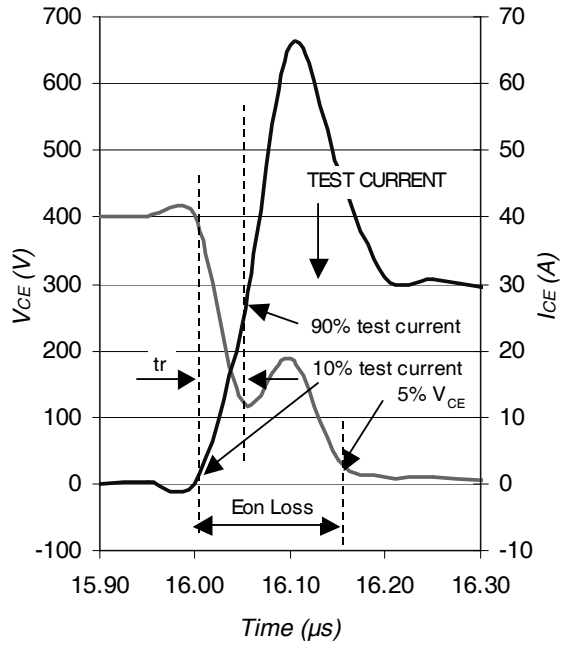

Fig. WF2- Typ. Turn-on Loss Waveform  
@  $T_J = 150^\circ\text{C}$  using Fig. CT.4

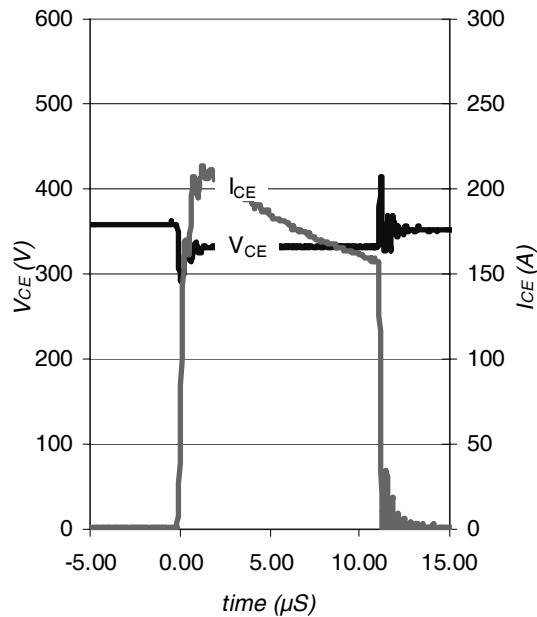
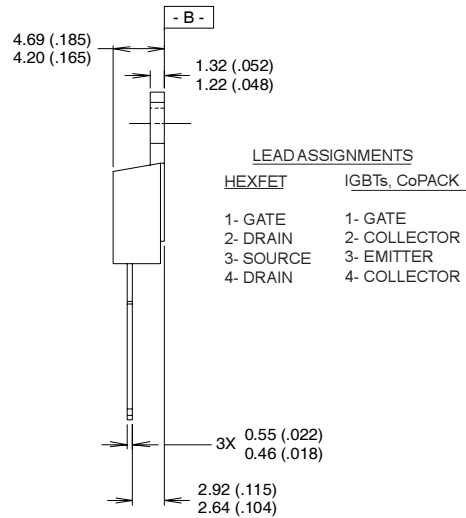
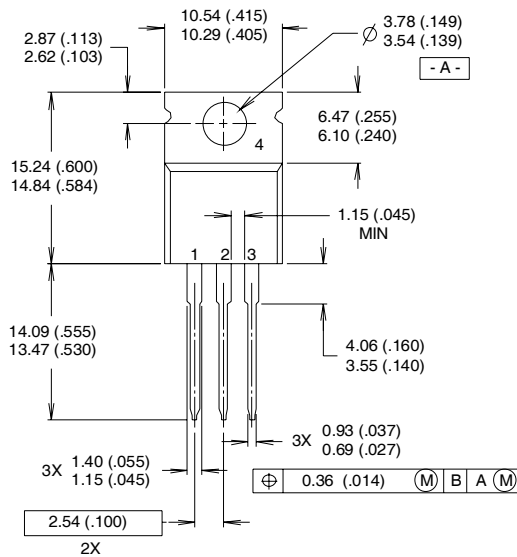

Fig. WF3- Typ. S.C Waveform  
@  $T_C = 150^\circ\text{C}$  using Fig. CT.3

# IRGB/S/SL30B60K

## TO-220AB Package Outline

Dimensions are shown in millimeters (inches)



**NOTES:**

- 1 DIMENSIONING & TOLERANCING PER ANSI Y14.5M, 1982.
- 2 CONTROLLING DIMENSION : INCH

- 3 OUTLINE CONFORMS TO JEDEC OUTLINE TO-220AB.
- 4 HEATSINK & LEAD MEASUREMENTS DO NOT INCLUDE BURRS.

## TO-220AB Part Marking Information

EXAMPLE: THIS IS AN IRF1010  
 LOT CODE 1789  
 ASSEMBLED ON WW 19, 1997  
 IN THE ASSEMBLY LINE "C"

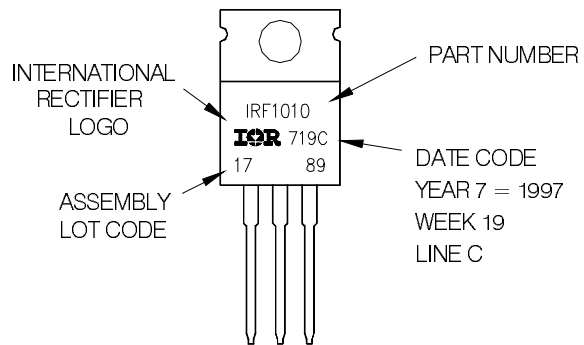

## D<sup>2</sup>Pak Package Outline

Dimensions are shown in millimeters (inches)

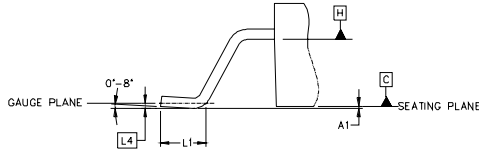

DETAIL "A"  
 ROTATED 90°  
 SCALE: 8:1

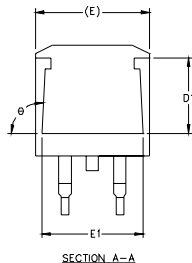

SECTION A-A

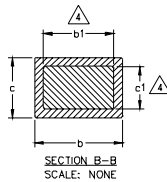

SECTION B-B  
 SCALE: NONE

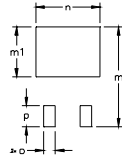

FOOT PRINT  
 SCALE: 2:1

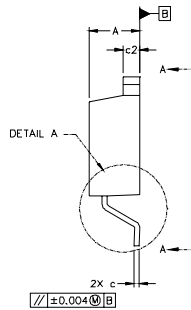
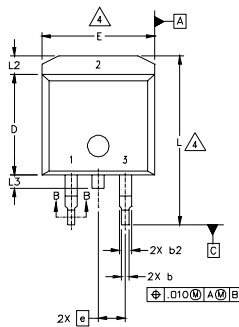

# IRGB/S/SL30B60K

SYMBOL	DIMENSIONS				NOTES
	MILLIMETERS		INCHES		
	MIN.	MAX.	MIN.	MAX.	
A	4.06	4.83	.160	.190	4
A1		0.127		.005	
b	0.51	0.99	.020	.039	
b1	0.51	0.89	.020	.035	
b2	1.14	1.40	.045	.055	4
c	0.43	0.63	.017	.025	
c1	0.38	0.74	.015	.029	3
c2	1.14	1.40	.045	.055	
D	8.51	9.65	.335	.380	3
D1	5.33		.210		
E	9.65	10.67	.380	.420	3
E1	6.22		.245		
e	2.54 BSC		.100 BSC		
L	14.61	15.88	.575	.625	
L1	1.78	2.79	.070	.110	
L2		1.65		.065	
L3	1.27	1.78	.050	.070	
L4	0.25 BSC		.010 BSC		
m	17.78		.700		
m1	8.89		.350		
n	11.43		.450		
o	2.08		.082		
p	3.81		.150		
$\theta$	90°	93°	90°	93°	

### LEAD ASSIGNMENTS

HEXFET	IGBTs, CoPACK	DIODES
1.- GATE	1.- GATE	1.- ANODE *
2.- DRAIN	2.- COLLECTOR	2.- CATHODE
3.- SOURCE	3.- EMITTER	3.- ANODE

\* PART DEPENDENT.

### NOTES:

1. DIMENSIONING AND TOLERANCING PER ASME Y14.5M-1994
2. DIMENSIONS ARE SHOWN IN MILLIMETERS [INCHES]
3. DIMENSION D & E DO NOT INCLUDE MOLD FLASH. MOLD FLASH SHALL NOT EXCEED 0.127 [.005"] PER SIDE. THESE DIMENSIONS ARE MEASURED AT THE OUTMOST EXTREMES OF THE PLASTIC BODY.
4. DIMENSION b1 AND c1 APPLY TO BASE METAL ONLY.
5. CONTROLLING DIMENSION: INCH.

## D<sup>2</sup>Pak Part Marking Information

EXAMPLE: THIS IS AN IRF530S WITH  
 LOT CODE 8024  
 ASSEMBLED ON WW 02, 2000  
 IN THE ASSEMBLY LINE "L"

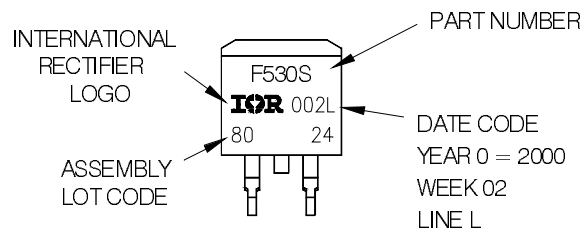

# IRGB/S/SL30B60K

## TO-262 Package Outline

Dimensions are shown in millimeters (inches)

International  
**IRF** Rectifier

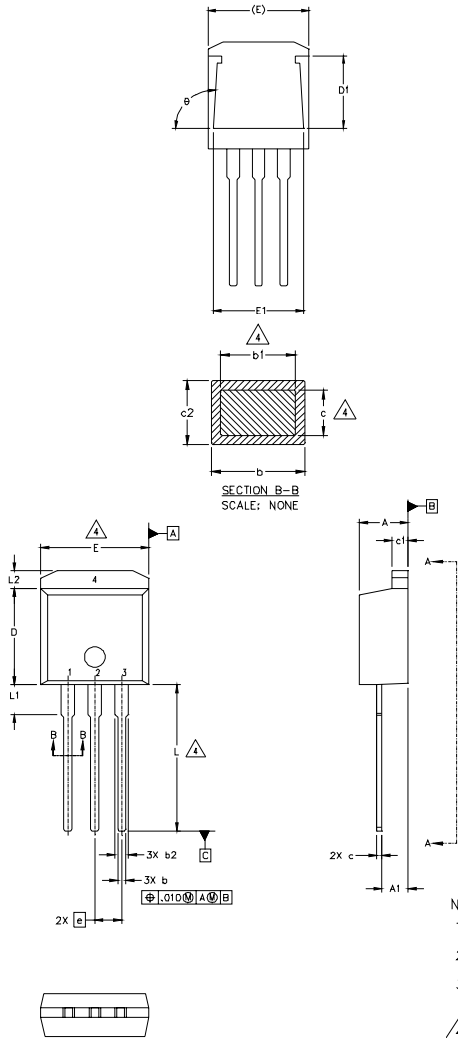

SYMBOL	DIMENSIONS				NOTES
	MILLIMETERS		INCHES		
	MIN.	MAX.	MIN.	MAX.	
A	4.06	4.83	.160	.190	
A1	2.03	2.92	.080	.115	
b	0.51	0.99	.020	.039	
b1	0.51	0.89	.020	.035	4
b2	1.14	1.40	.045	.055	
c	0.38	0.63	.015	.025	4
c1	1.14	1.40	.045	.055	
c2	0.43	.063	.017	.029	
D	8.51	9.65	.335	.380	3
D1	5.33		.210		
E	9.65	10.67	.380	.420	3
E1	6.22		.245		
e	2.54 BSC		.100 BSC		
L	13.46	14.09	.530	.555	
L1	3.56	3.71	.140	.146	
L2		1.65		.065	

### LEAD ASSIGNMENTS

HEXFET	IGBT
1.- GATE	1- GATE
2.- DRAIN	2- COLLECTOR
3.- SOURCE	3- EMITTER
4.- DRAIN	4- COLLECTOR

#### NOTES:

1. DIMENSIONING AND TOLERANCING PER ASME Y14.5M-1994
2. DIMENSIONS ARE SHOWN IN MILLIMETERS [INCHES]
3. DIMENSION D & E DO NOT INCLUDE MOLD FLASH. MOLD FLASH SHALL NOT EXCEED 0.127 [.005"] PER SIDE. THESE DIMENSIONS ARE MEASURED AT THE OUTMOST EXTREMES OF THE PLASTIC BODY.
4. DIMENSION b1 AND c1 APPLY TO BASE METAL ONLY.
5. CONTROLLING DIMENSION: INCH.

## TO-262 Part Marking Information

EXAMPLE: THIS IS AN IRL3103L  
LOT CODE 1789  
ASSEMBLED ON WW 19, 1997  
IN THE ASSEMBLY LINE "C"

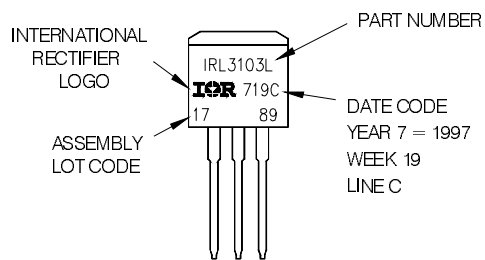

## D<sup>2</sup>Pak Tape & Reel Information

Dimensions are shown in millimeters (inches)

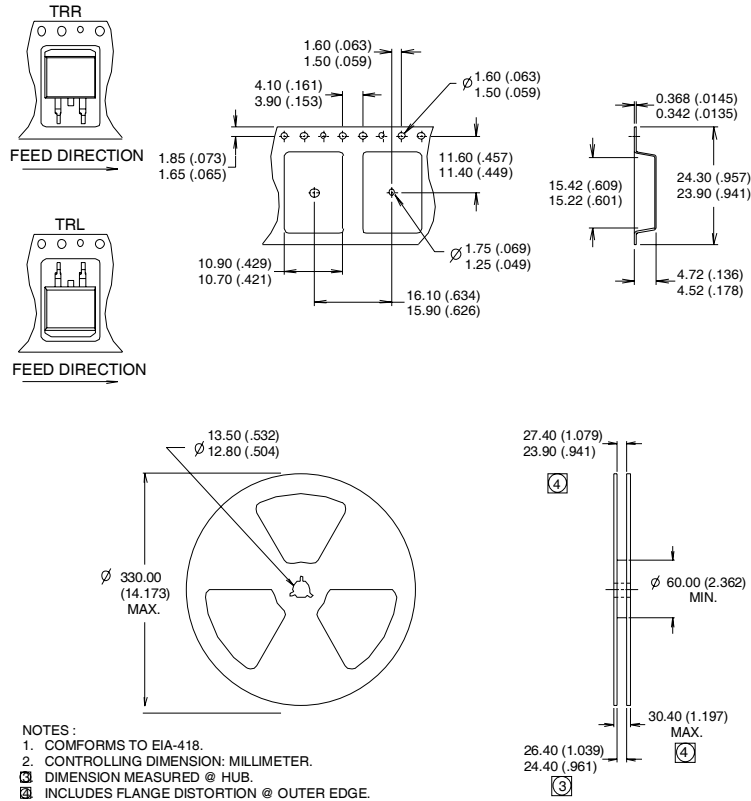

### Notes:

- ①  $V_{CC} = 80\% (V_{CES})$ ,  $V_{GE} = 20V$ ,  $L = 28\mu H$ ,  $R_G = 22\Omega$ .
- ② This is only applied to TO-220AB package.
- ③ This is applied to D<sup>2</sup>Pak, when mounted on 1" square PCB (FR-4 or G-10 Material).  
 For recommended footprint and soldering techniques refer to application note #AN-994.
- ④ Energy losses include "tail" and diode reverse recovery.
- ⑤ Calculated continuous current based on maximum allowable junction temperature. Package limitation current is 75A.

**TO-220AB package is not recommended for Surface Mount Application.**

Data and specifications subject to change without notice.

International  
**IR** Rectifier

IR WORLD HEADQUARTERS: 233 Kansas St., El Segundo, California 90245, USA Tel: (310) 252-7105

TAC Fax: (310) 252-7903

Visit us at [www.irf.com](http://www.irf.com) for sales contact information. 02/04

Note: For the most current drawings please refer to the IR website at:  
<http://www.irf.com/package/>

# Mouser Electronics

Authorized Distributor

Click to View Pricing, Inventory, Delivery & Lifecycle Information:

[Infineon:](#)

[IRGS30B60KTRRP](#)