

THIS DRAWING IS UNPUBLISHED. RELEASED FOR PUBLICATION
 © COPYRIGHT BY ALL RIGHTS RESERVED.

LOC		DIST		REVISIONS			
P	LTR	DESCRIPTION	DATE	DWN	APVD		
P		REVISED PER ECO-11-005139	19MAR11	RK	HMR		

- NOTES:
- 1 MATERIAL HOUSING: THERMOPLASTIC, UL 94V-0.
POST : BRASS
 - 2 FINISH CONTACT AREA, "D" MIN Au
ON NICKEL 0.0013 MIN ALL OVER
POST TINE: 0.002 MIN MATTE TIN
 - 3 POST POSITION NUMBERS FOR REFERENCE ONLY.

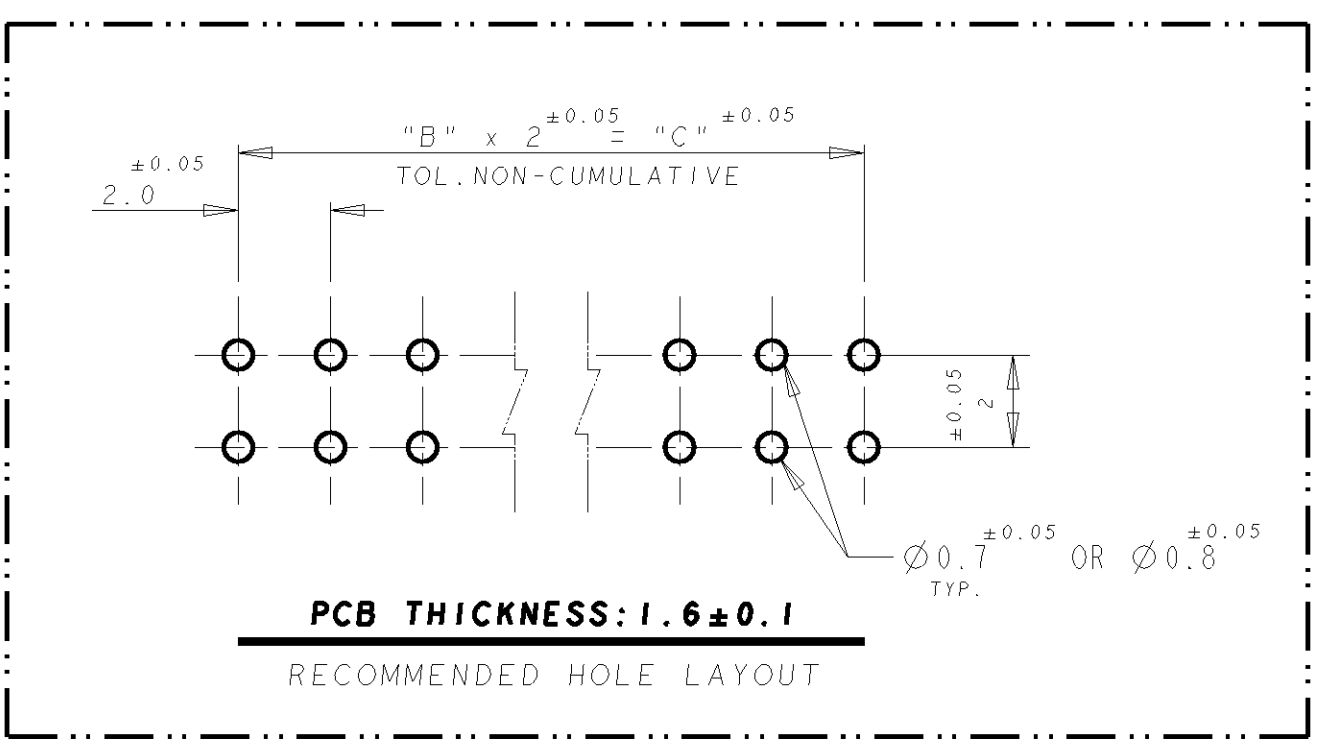
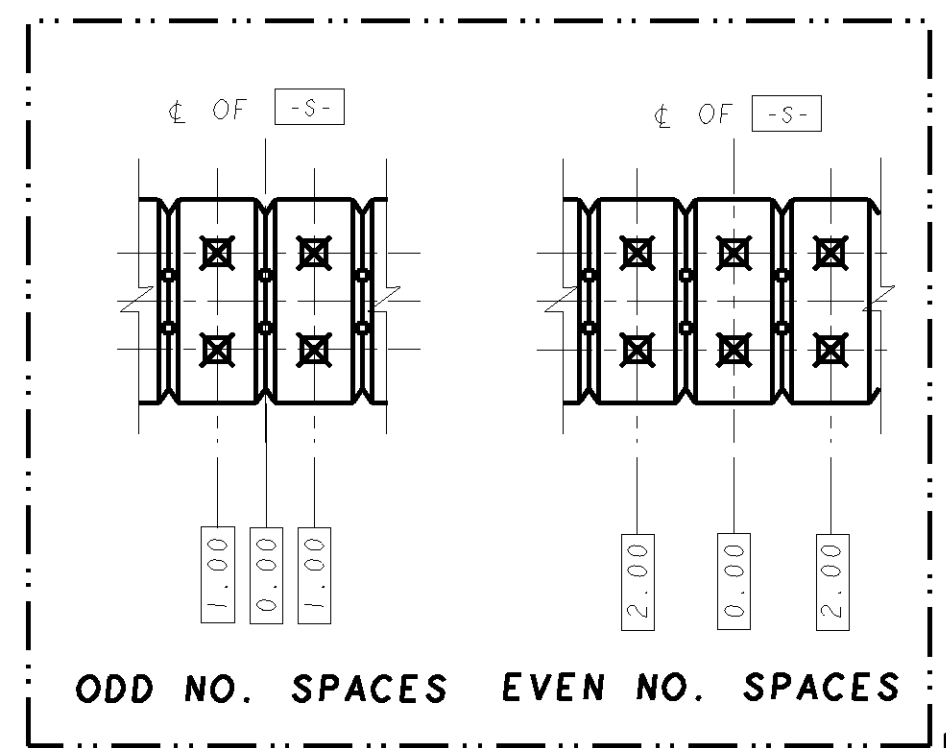
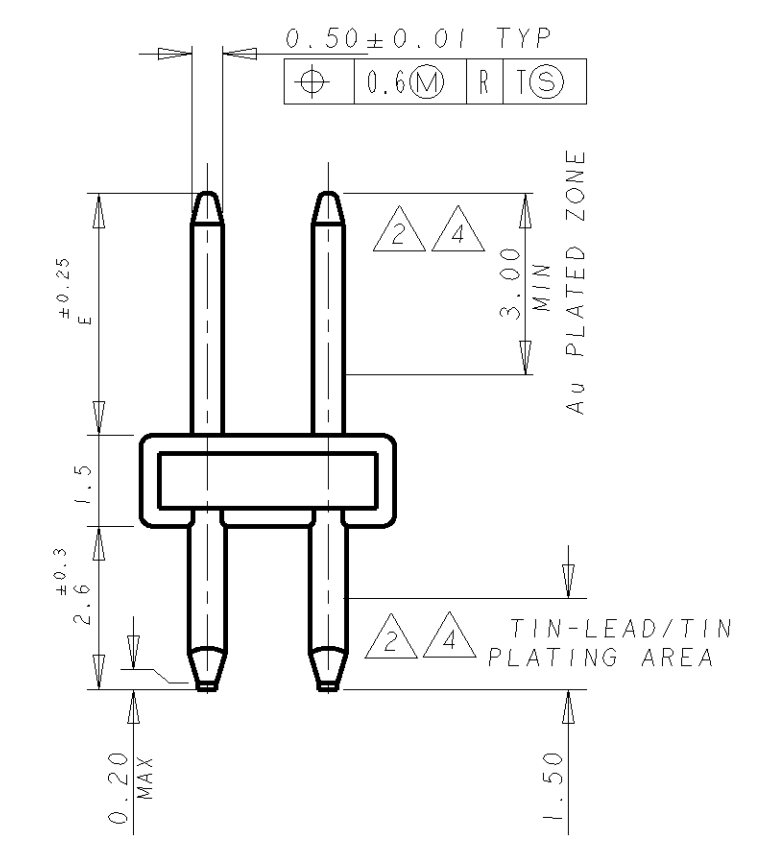
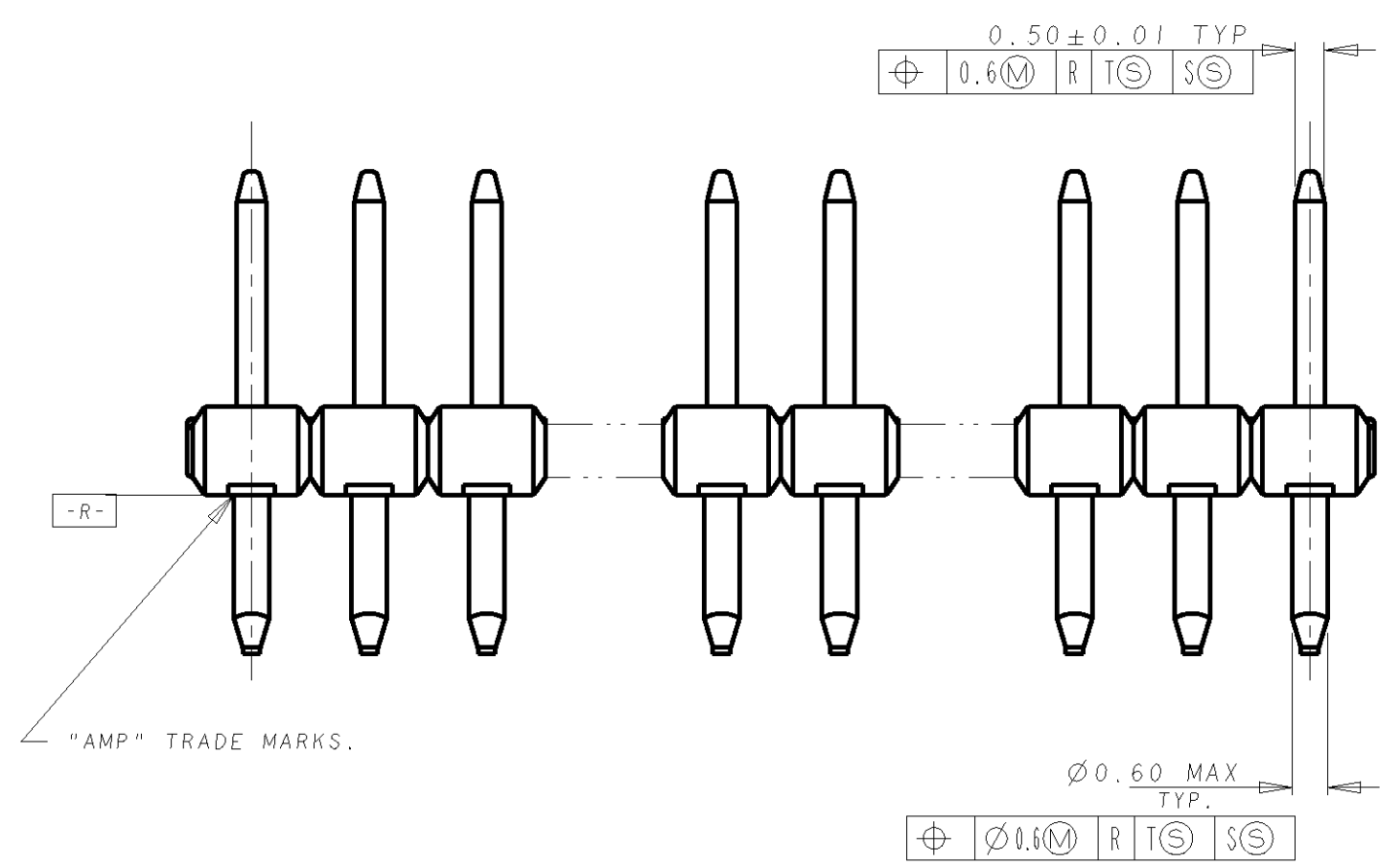
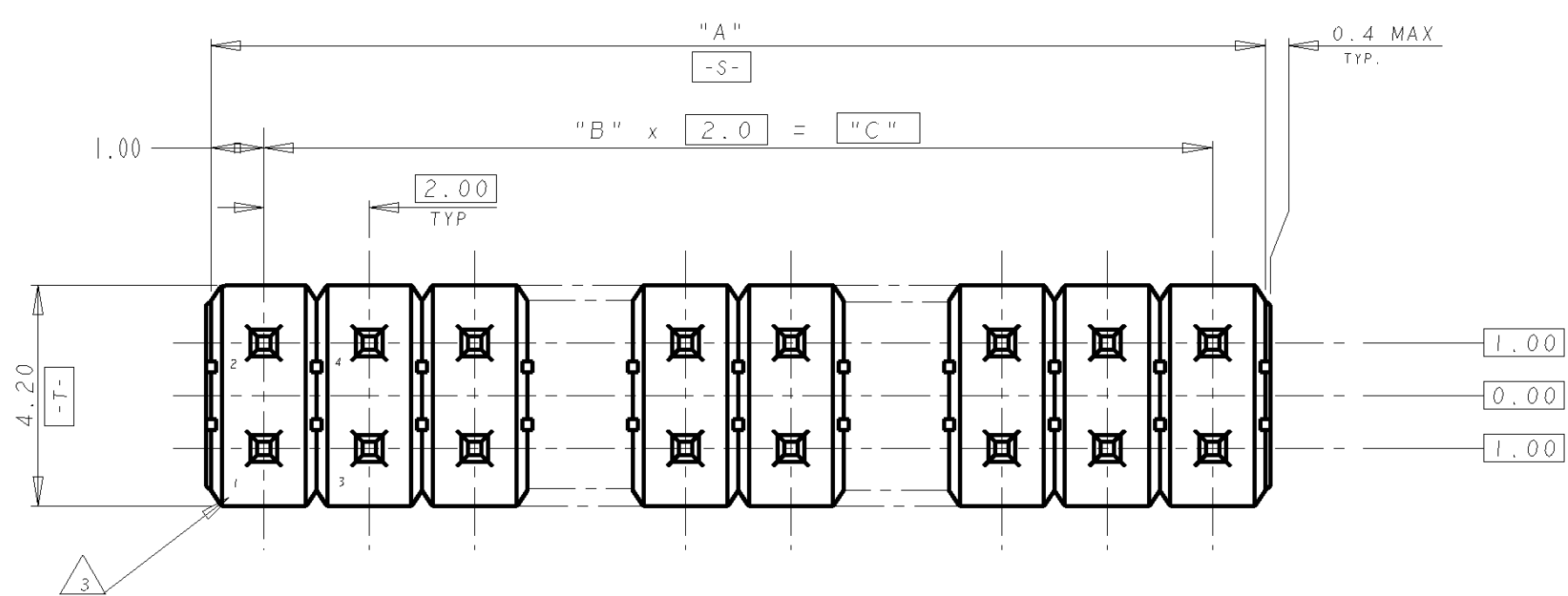

GENERAL TOLERANCE

0 <= < 10	: ±0.2
10 <= < 30	: ±0.25
30 <= < 100	: ±0.3
ANGLES	: ±3°

NIL	4.00	0.0002	4	2	6	6	5-	-8
17	4.00	0.00076	24	12	26	26	5-	-7
9, 10	5.00	0.00076	24	12	26	26	5-	-6
1, 14		0.00076	14	7	16	16	5-	-5
1, 12		0.00076	10	5	12	12	5-	-4
NIL		0.00076	--	--	2	2	5-	-3
25		0.00076	48	24	50	50	5-	-2
25		0.0002	48	24	50	50	5-	-1
			48	24	50	50	4-	-8
			46	23	48	48	4-	-7
			44	22	46	46	4-	-6
			42	21	44	44	4-	-5
		0.00076	34	17	36	36	4-	-1
			48	24	50	50	3-	-9
			42	21	44	44	3-	-6
		0.0002	34	17	36	36	3-	-2
			28	14	30	30	2-	-9
			22	11	24	24	2-	-6
			20	10	22	22	2-	-5
			18	9	20	20	2-	-4
			16	8	18	18	2-	-3
			14	7	16	16	2-	-2
			12	6	14	14	2-	-1
			10	5	12	12	2-	-0
			8	4	10	10	1-	-9
			6	3	8	8	1-	-8
			4	2	6	6	1-	-7
		0.00076	2	1	4	4	1-	-6
			30	15	32	32	1-	-5
			28	14	30	30	1-	-4
			26	13	28	28	1-	-3
			22	11	24	24	1-	-1
			20	10	22	22	1-	-0
			18	9	20	20		-9
			16	8	18	18		-8
			14	7	16	16		-7
			12	6	14	14		-6
			10	5	12	12		-5
			8	4	10	10		-4
			6	3	8	8		-3
			2	1	4	4		-1
FINISH	PIN OMITTED	"E"	"D"	"C"	"B" SPACES	"A"	POS	P/N
								5176264-1

DIMENSIONS: mm		TOLERANCES UNLESS OTHERWISE SPECIFIED:		DWN WYLEE 07MAR2005		TE Connectivity	
MATERIAL		FINISH		CHK VINCENT TAN		NAME	
0 PLC ±		1 PLC ±		APVD SF LEONG		AMPMODU 2mm PITCH POST HDR, VERTICAL MOUNT TYPE	
2 PLC ±		3 PLC ±		PRODUCT SPEC		SIZE	
4 PLC ±		ANGLES ±		APPLICATION SPEC		CAGE CODE	
				WEIGHT		DRAWING NO	
				CUSTOMER DRAWING		A2 00779	
						SCALE 8.1	
						SHEET OF	
						REV P	

5176264

Mouser Electronics

Authorized Distributor

Click to View Pricing, Inventory, Delivery & Lifecycle Information:

[TE Connectivity:](#)

[3-5176264-9](#)