

NOTES:

1. EACH SET SCREW IS THREADED INTO A HIGH TORQUE, BRASS INSERT DESIGNED TO PREVENT THREAD STRIPPING.
2. DECORATIVE SPUN ALUMINUM INLAY
3. PLASTIC OVERLAY MUST BE PRESENT ON TOP SURFACE.

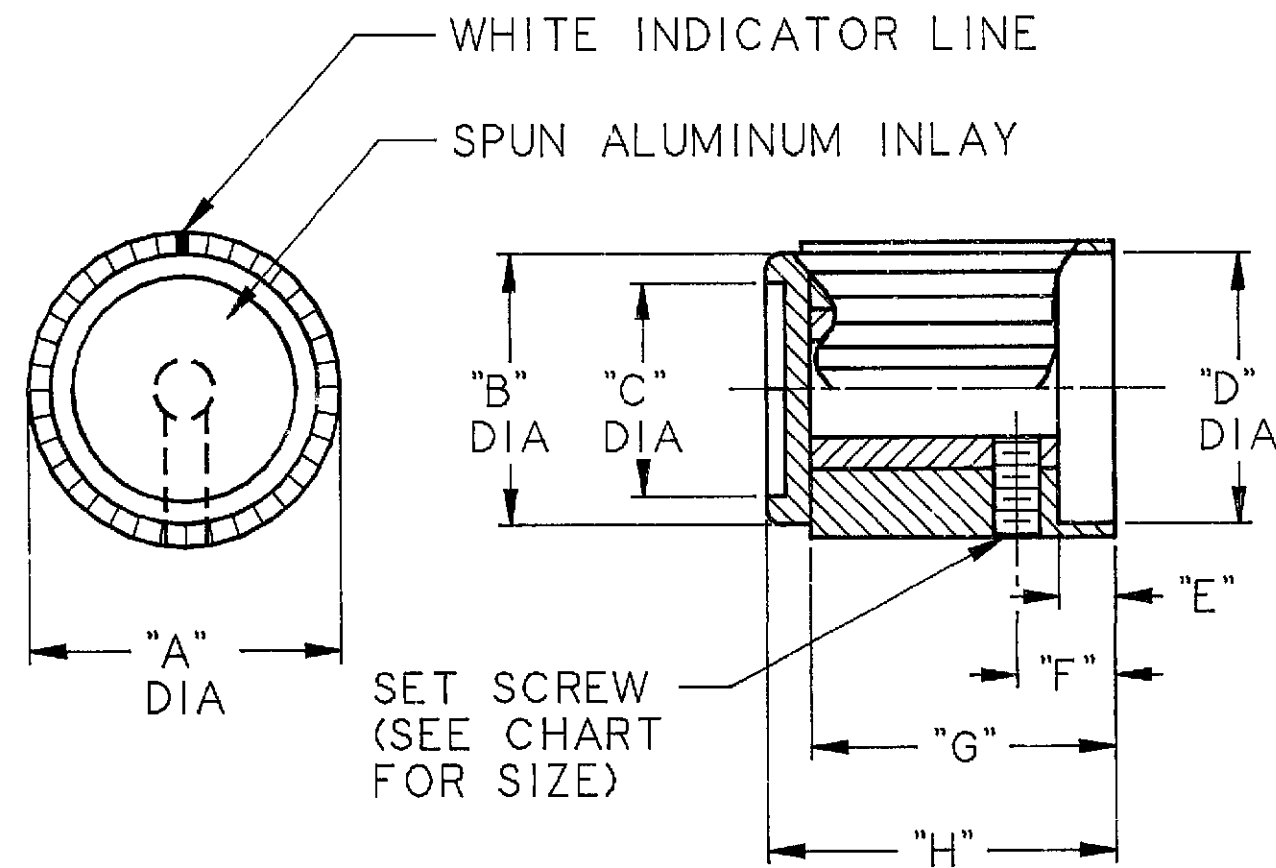

TOLERANCES UNLESS NOTED			
.020-.157 [0,50-4,00]	+ .004 [0,10]	SHAFT .251 [6,38]	+ .003 [0,07]
.158-.630 [4,01-16,00]	+ .010 [0,25]	.126 [3,20]	- .000 [0,00]
.631-2.520 [16,03-64,00]	+ .015 [0,38]	ANGULAR ±2 NON ACCUMULATIVE	

MODEL	COLOR	SHAFT DIA.	SET SCR.	"A"	"B"	"C"	"D"	"E"	"F"	"G"	"H"
PKG-40B	BLACK	.126 (3,20)	4-40	.437 (11,10)	.410 (10,41)	.304 (7,72)	.315 (8,00)	.079 (2,00)	.197 (5,00)	.385 (9,78)	.472 (11,99)
PKG-40R	RED	.126 (3,20)	4-40	.437 (11,10)	.387 (9,83)	.304 (7,72)	.315 (8,00)	.079 (2,00)	.197 (5,00)	.433 (11,00)	.472 (11,99)
PKG-50B	BLACK	.126 (3,20)	6-32	.551 (13,99)	.500 (12,70)	.422 (10,72)	.441 (11,20)	.056 (1,42)	.190 (4,83)	.395 (10,03)	.512 (13,00)
PKG-50B	BLACK	.251 (6,38)	6-32	.551 (13,99)	.500 (12,70)	.422 (10,72)	.441 (11,20)	.056 (1,42)	.190 (4,83)	.395 (10,03)	.512 (13,00)
PKG-50R	RED	.126 (3,20)	6-32	.551 (13,99)	.503 (12,77)	.422 (10,72)	.441 (11,20)	.079 (2,00)	.197 (5,00)	.422 (10,72)	.512 (13,00)
PKG-50R	RED	.251 (6,38)	6-32	.551 (13,99)	.503 (12,77)	.422 (10,72)	.441 (11,20)	.079 (2,00)	.197 (5,00)	.422 (10,72)	.512 (13,00)
PKG-60B	BLACK	.126 (3,20)	6-32	.660 (16,76)	.615 (15,62)	.512 (13,00)	.551 (13,99)	.080 (2,03)	.226 (5,74)	.430 (10,92)	.551 (13,99)
PKG-60B	BLACK	.251 (6,38)	6-32	.660 (16,76)	.615 (15,62)	.512 (13,00)	.551 (13,99)	.080 (2,03)	.226 (5,74)	.430 (10,92)	.551 (13,99)
PKG-60R	RED	.126 (3,20)	6-32	.673 (17,09)	.615 (15,62)	.512 (13,00)	.551 (13,99)	.122 (3,10)	.217 (5,51)	.461 (11,71)	.551 (13,99)
PKG-60R	RED	.251 (6,38)	6-32	.673 (17,09)	.615 (15,62)	.512 (13,00)	.551 (13,99)	.122 (3,10)	.217 (5,51)	.461 (11,71)	.551 (13,99)
PKG-70B	BLACK	.251 (6,38)	6-32	.740 (18,80)	.698 (17,73)	.591 (15,01)	.591 (15,01)	.080 (2,03)	.230 (5,84)	.453 (11,51)	.559 (14,20)
PKG-70B	BLACK	.126 (3,20)	6-32	.740 (18,80)	.698 (17,73)	.591 (15,01)	.591 (15,01)	.080 (2,03)	.230 (5,84)	.453 (11,51)	.559 (14,20)
PKG-70R	RED	.251 (6,38)	6-32	.740 (18,80)	.698 (17,73)	.591 (15,01)	.591 (15,01)	.122 (3,10)	.217 (5,51)	.453 (11,51)	.559 (14,20)

TOLERANCES UNLESS OTHERWISE NOTED, INCH [MM]

DECIMAL METRIC  
.XX±  
.XXX± SEE CHART  
FRACTIONAL ANGULAR  
X/X°

THIRD ANGLE PROJECTION REFER TO ANSI Y14.5M-1982 FOR DWG. INTERPRETATION

DO NOT SCALE DRAWING

DATE	8/88	DRAWING STATUS	<input type="checkbox"/> PRELIMINARY
CHKD:	TRC	<input type="checkbox"/> QUOTES	
ENGR:	PB	<input type="checkbox"/> PROTOTYPE	
		<input type="checkbox"/> PRE-PRODUCTION	
		<input type="checkbox"/> RELEASE	
DATA BASE: ECO2992			
MATERIAL: MOLDED PHENOLIC RESIN			
ALCO CONFIDENTIAL			
This document contains information which is the exclusive property of Alco Electronics Products Inc. Distribution, reproduction or use by others is not permitted without the express written consent of Alco Electronics Products Inc.			

A1	REVISED PER ECO-11-004820	RK	HMR
A	RELEASED		
REV.	E.C.O.	CHK.	APP.
<b>STE</b> TE Connectivity			
TITLE <b>KNOB SERIES</b> (PKG -40, -50, -60, -70)			
SIZE	PROD. LINE	DWG. NO.	REV.
C		5-1437624-9	A1
SCALE 4/1		SHEET 1 OF 1	CUSTOMER DRAWING

# Mouser Electronics

Authorized Distributor

Click to View Pricing, Inventory, Delivery & Lifecycle Information:

[TE Connectivity:](#)

[PKG70B1/4](#)